



# WIFI Function User Manual

## Portable Air Conditioner



**This description is applied to Air Conditioners with WIFI function. Please read the manual carefully before using the product and keep it for future reference.**



# WI-FI APP INSTRUCTION MANUAL

Please scan the QR code to download the latest App software.

The latest App software integrated air conditioner, dehumidifier and Portable air conditioner



iOS



Androide



## SERVICE CONDITION

Thank you for choosing our air conditioner.

This manual apply to the air conditioners which has WiFi function.

Please read the manual carefully before using the product and keep it properly for further review.

Please do not unplug the WIFI module by yourself.

For technical update, there may be deviation of the actual items from the manual. We express our apologies.

Please refer to your actual product.

## INSTALL THE APP

When download the APP software, you can install it in your smart phone.

After installation, you can find the "Smart Life" icon on your phone desk.

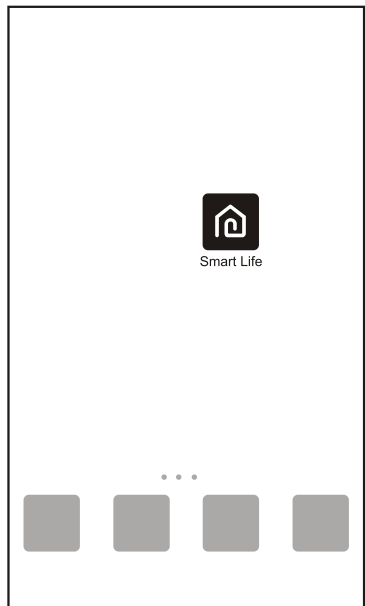
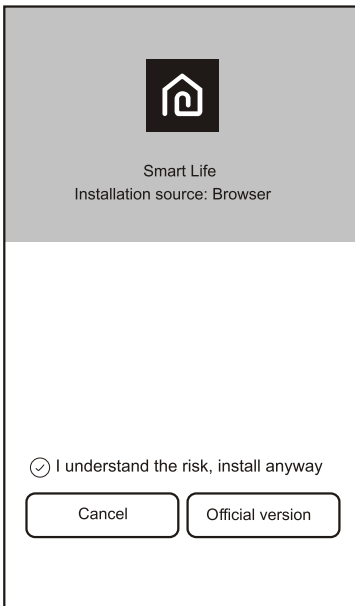

## ACTIVATE QR CODE

1. When you first time enter the App, it will display activation interface, you can select scan activation QR code (click “Scan” button and scan the activation QR code in below page) or input “activation code” words (in be- low page), click “activate” button to active it.

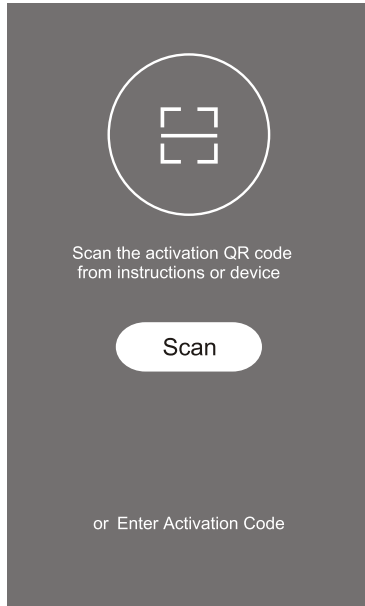

2. Air conditioner activation QR code



3. Air conditioner activation code WORDS: GLOBAL

## REGISTER USER ACCOUNT

When you first time use the App, you need to register an account. Click "Register" button to enter to the register interface. You can register with email or "Register with Mobile number".

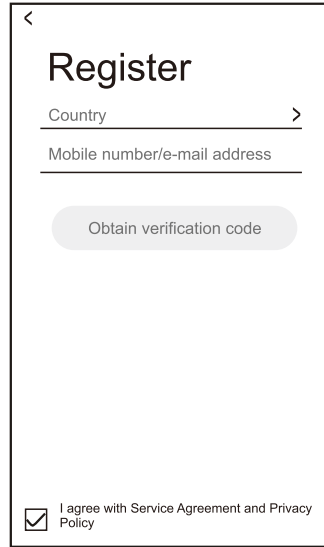

## LOGIN USER ACCOUNT

1. Register account login, fulfill the registered email or phone number account and password, press "Login" button.
2. Phone number login, press "Sign in with SMS" button to enter the next page, fulfill the phone number and press "get" button to receive the confirm code, and fill in, then press "Login" button.

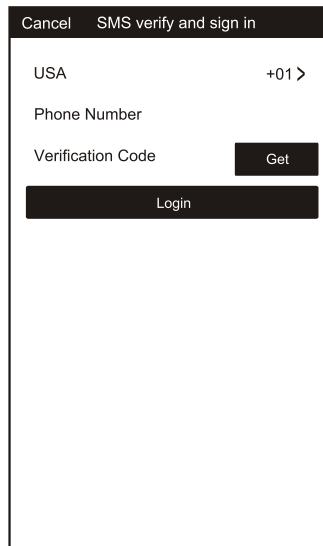
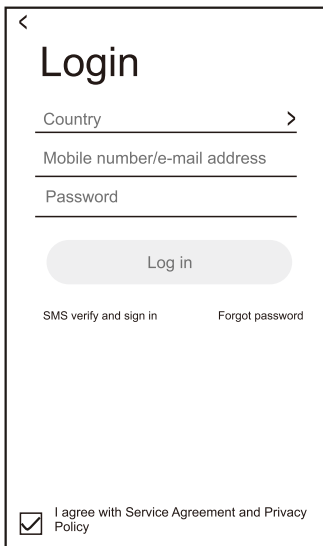

# FORGET PASSWORD

1. Press the "Forgot password" button to the next page.
2. Fulfill the registered phone number or email account, press "Next" button to the next page.
3. You will receive the verification code, fulfill it, and set the new password, press "confirm" button.

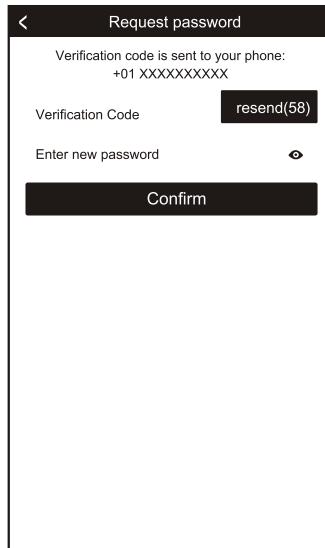
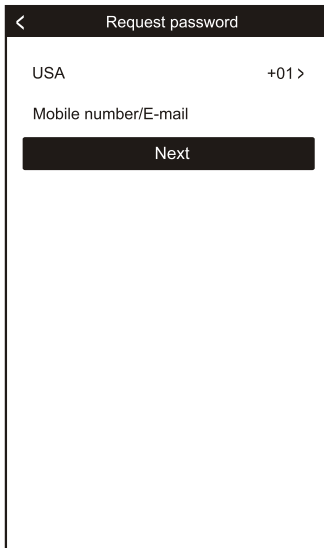
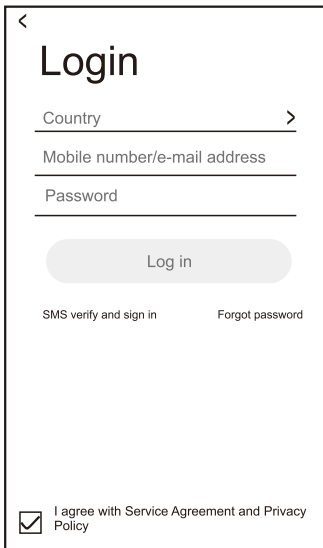

# ADD THE DEVICE

1. Press "Add Device" button to next page, select the product type.
2. There are two methods to do the device match, "CF" or "AP mode" You can choose by the different button

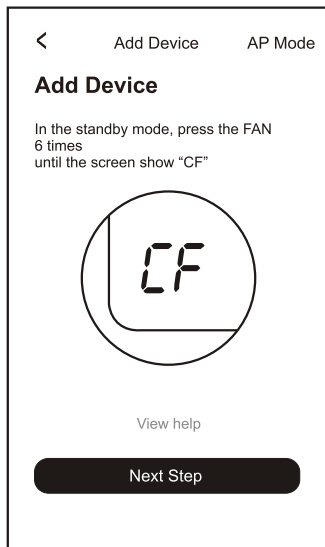
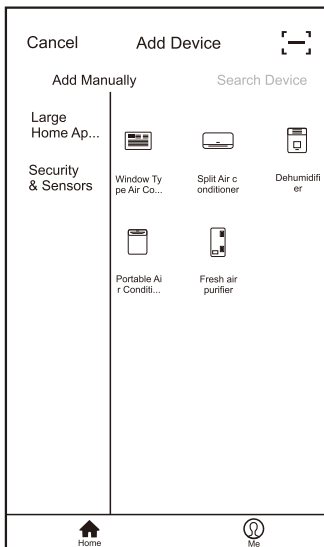
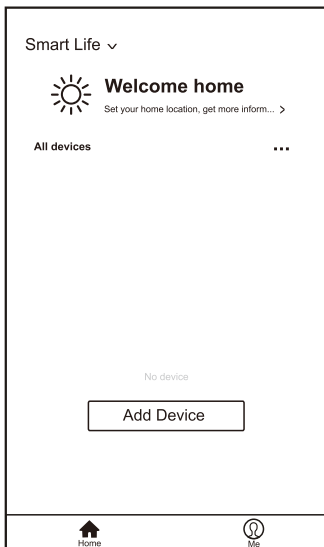

# ADD THE DEVICE (CF MODE)

1. The system defaults to CF mode at first, Press "Next Step" to continue.
2. Select the home router, and fulfill the password of router, press "Next" to continue.
3. In standby, press the "FAN" key on the control panel (or remote control) 6 times within 4 seconds until the LCD screen show "CF" or "AP", which can make WIFI reset, there will be switch between "CF" and "AP" if press many times.

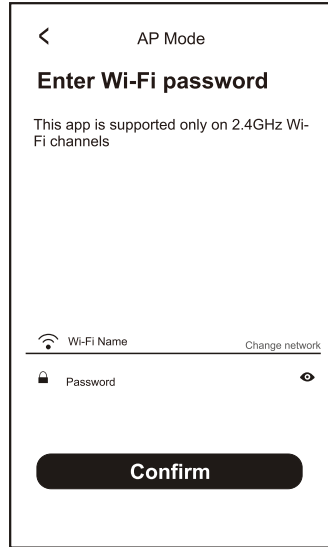
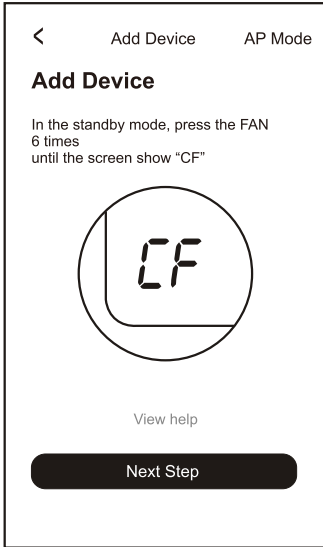

4. The APP software will automatically do the device match.
5. After match successfully, the page will display the prompt as below.
6. You can "Rename" the device name as you like, or share with family, or press "Done" to start to control the device

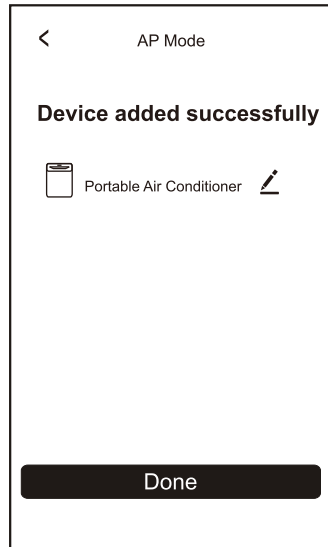
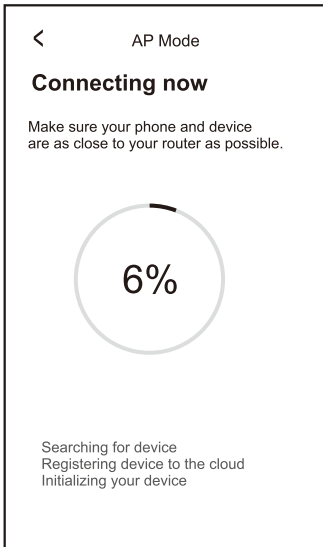

# ADD THE DEVICE (AP MODE)

1. Click the "AP Mode" to the "AP" page. Press "Next Step" to continue.
2. Select the home router, fulfill the password, press "Next" to continue
3. In standby, press the "FAN" key on the control panel (or remote control) 6 times within 4 seconds until the LCD screen show "CF" or "AP", which can make WIFI reset, there will be switch between "CF" and "AP" if press many times.

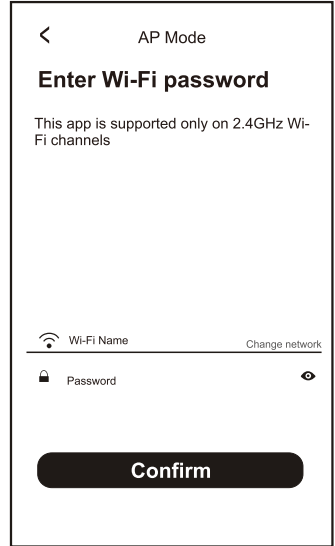
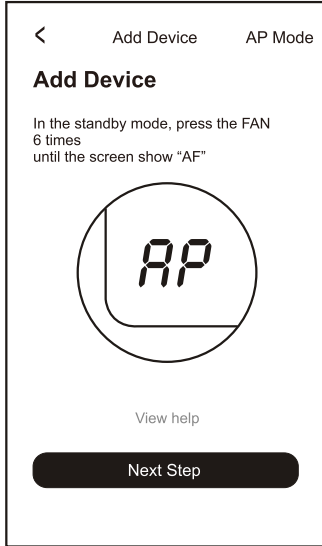
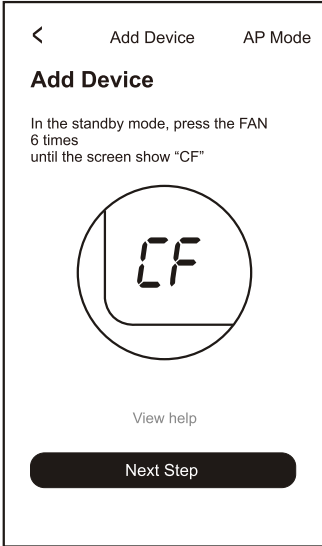

4. Select the AC Device as name "SmartLife-XXX" at the WLAN setting, then back to the APP interface. The APP will automatically do match

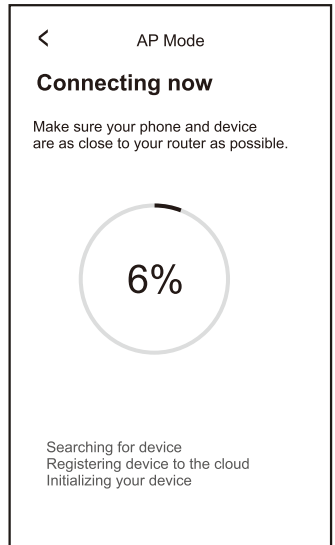
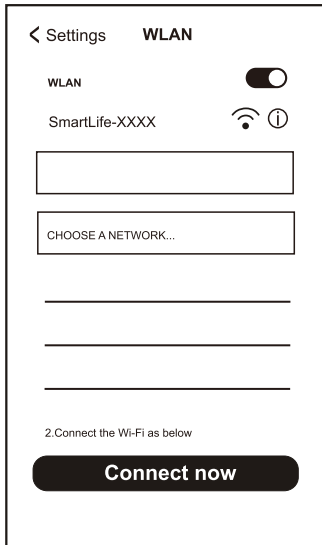
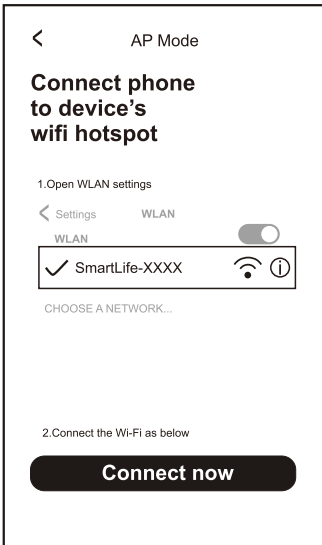



5. After match successfully, the page will display the prompt as below.
6. If match failed, the APP will mention it, and press "Retry" to try again.

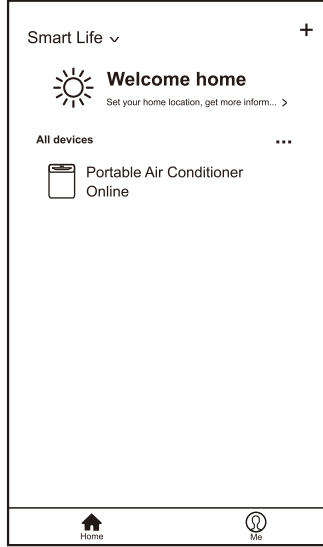
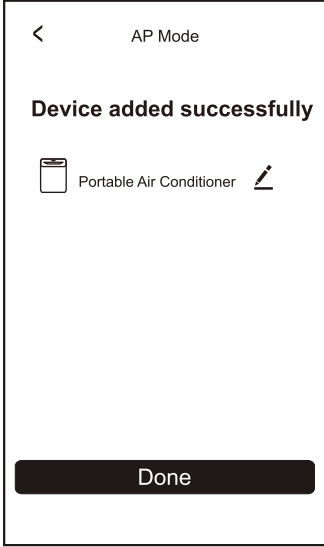

## PAIRING PROCESS

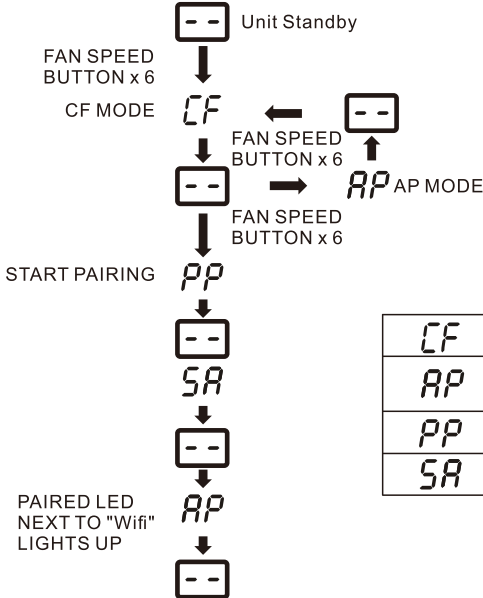

CF	Waiting pair after reset
AP	1) Hotspot connect mode 2) Access to the Internet
PP	Searching and try to connect
SR	Connect successful

# AIR CONDITIONER CONTROL

1. Click the air conditioner name to enter the control interface. Turn ON/OFF. Adjust the setting temperature.

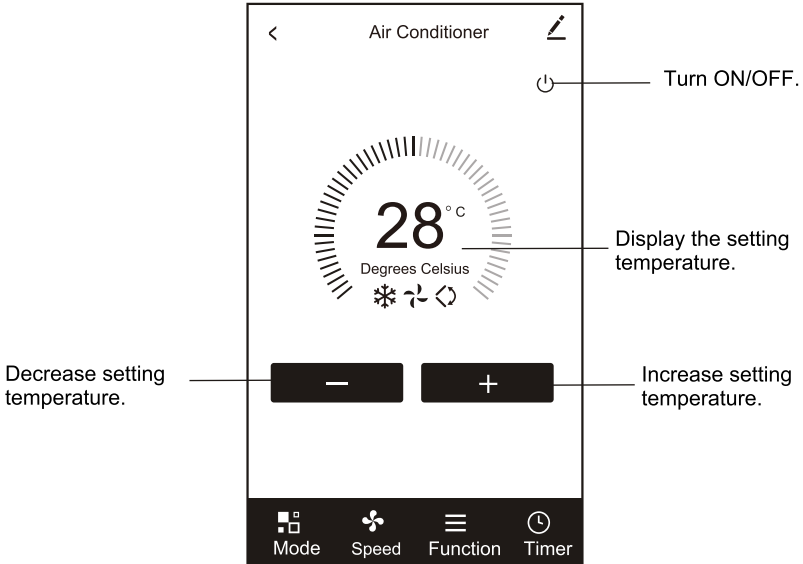

\*For App update, there may be deviation of the actual items from what is on the manual without prior notice. We express our apologies.

2. Adjust the different operating mode, Cool, Heat, Dry, Fan, Auto mode. Click the "Mode" button, and choose different running mode as you like. For some cooling only unit, the heat mode is not useful. For Dry mode, at the first 3 minutes, the APP temperature display may be little different from the unit display, caused by the unit temperature fast changing.

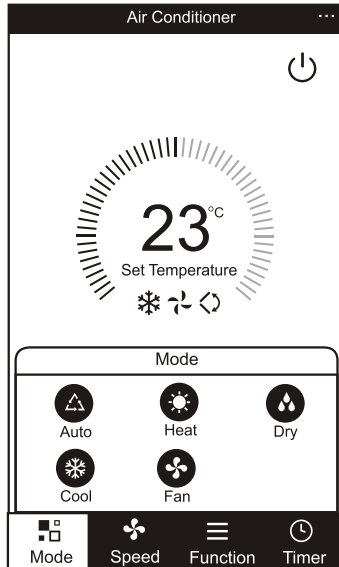

3. Click the "Fan" button, choose different fan speed, Low, Med, High, Auto.

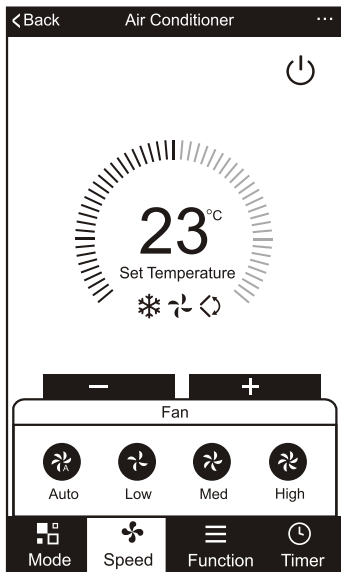

4. Other function control can be selected by "Function" button, Sleep. When Sleep mode, the fan speed will be fixed to low speed.

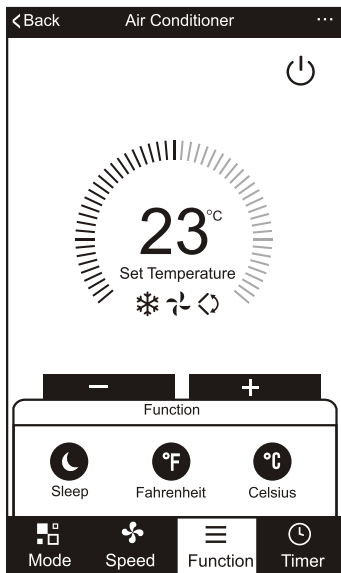

5. Setting Timer function. Click the "Timer" button, the APP will enter to timer setting interface. It will display the task scheduler set before. You can longterm press to edit or build a new scheduler by "Add Timer" button.

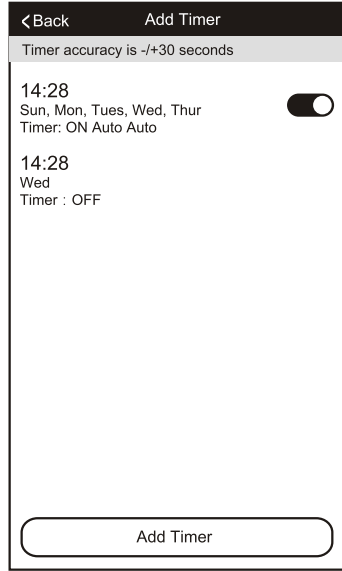
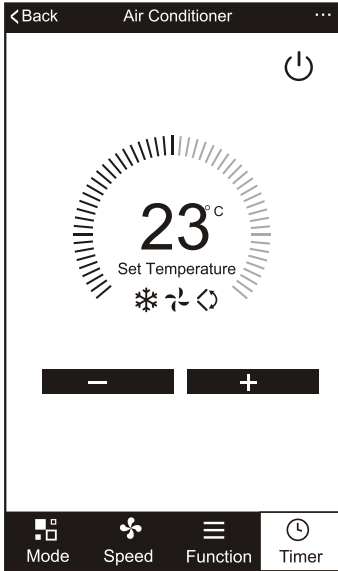

6. Click "ON" or "OFF" button to set Timer ON or Timer OFF.

You can set Hour, Minute, operate Mode, operate Fan Speed, operate Temperature, also the weekly Timer. After finish the setting, click the button to cancel or confirm.

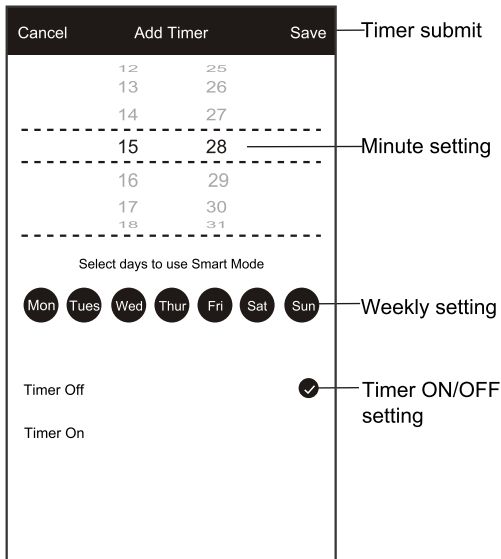

7. More setting. From the right-up corner, you can do more function setting, as Modify Device Name, Device Sharing, Device information, Feedback, Check for firmware update, Remove Device, Restore Manufacture setting.

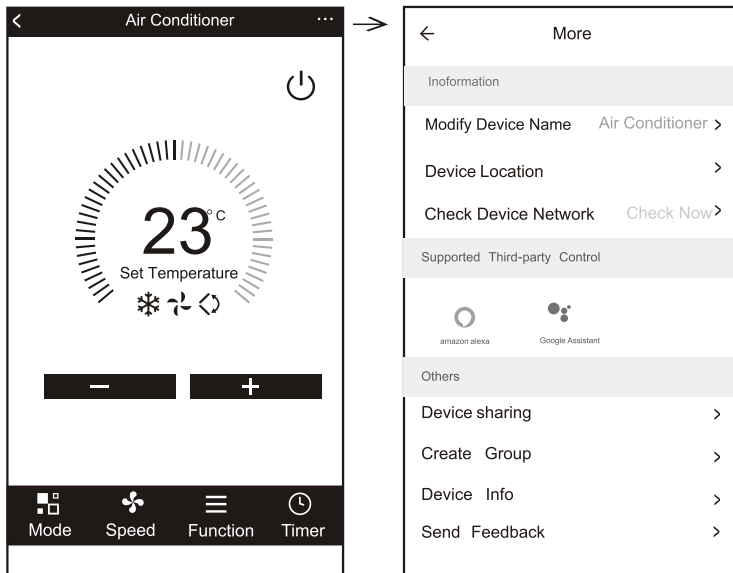

8. Profile. You can manage your personal information. It includes:

- a, Account information.
- b, Scan QR code: Developers could preview the control interface.
- c, Share Device: Display user s device sharing information.
- d, Message Centre: Displays all messages that system sent to users.
- e, Feedback: Where users could submit feedback online.
- f, About: Displays the current App version information.

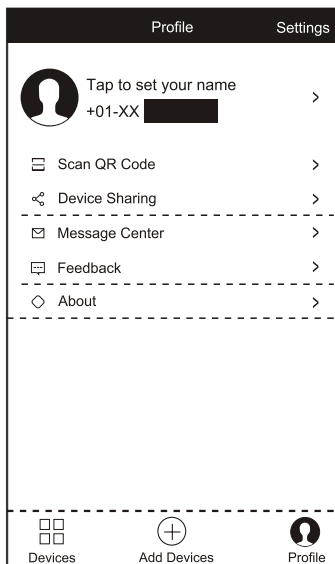

9. Pattern unlock. Tap "Pattern unlock" to set up your App unlock pattern.  
After it is enabled, you need to draw the pattern to unlock the App.

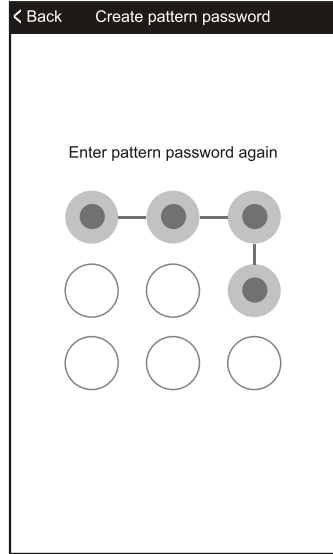
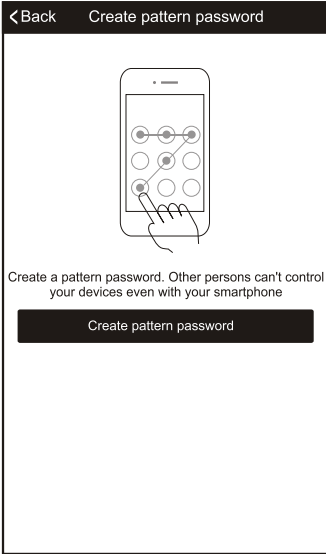

## TROUBLE SHOOTING

Description	Analysis of cause
Air conditioner can't be configured successfully	<ol style="list-style-type: none"> <li>1. Check the mobile connected WIFI address and password is correct;</li> <li>2. Check the air conditioner under configuration status;</li> <li>3. There are any firewall or other restrictions have been set or not;</li> <li>4. check the router work normally;</li> <li>5. Make sure air conditioner, router and mobile work within signal scope</li> <li>6. Check router shielding App or not</li> </ol>
Mobile can't control air conditioner	<p>Software display: Identification failed, It means the air conditioner has been reset, and the mobile phone lost control permission. You need to connect WIFI to get permission again. Please connect the local network and refresh it. After all still can't work, please delete air conditioner and wait its refresh.</p>
Mobile can't find air conditioner	<p>Software display: Air conditioner out of line. Please check network working</p> <ol style="list-style-type: none"> <li>1. The air conditioner has been reconfiguration</li> <li>2. Air conditioner out of power</li> <li>3. Router out of power</li> <li>4. Air conditioner can't connect to router</li> <li>5. Air conditioner can't connect to network through the router(under remote control mode)</li> <li>6. Mobile can't connect to router(Under local control mode);</li> <li>7. The mobile phone can't connect to network (under remote control mode).</li> </ol>

