

# W SERIES

---

## Automatic Sealers

Models: W-300A, W-305A, W-450A, W-455A, W-600A, W-605A  
W-3010A, W-4510A, W-6010A, W-755AA, W-905AA, W-  
1205AAA, W-1505AAA, W-305AT, W-455AT

## **Distributed By:**

Version 1.4.2  
Last Updated 2/25/20

## **WHA INSTRUCTION MANUAL**

Copyright © 2015 by Stephanie Hwang

All rights reserved. No part of this publication may be reproduced, distributed, or transmitted in any form or by any means, including photocopying, recording, or other electronic or mechanical methods, without the prior written permission of the publisher, except in the case of brief quotations embodied in critical reviews and certain other noncommercial uses permitted by copyright law. For permission requests, write to the publisher, addressed "Attention: Permissions Coordinator," at the address below.

Sealer Sales, Inc.  
8820 Baird Avenue  
Northridge, Ca 91324  
[www.sealersales.com](http://www.sealersales.com)

Printed in the United States of America

# General Information

---

## Thank you for purchasing our W-Series Automatic Sealers

This owner's manual contains information relating to your sealer. The manual will provide you with basic information concerning both operation and maintenance of your new machine. Please read it carefully as failure to do so may result in bodily injury and/or damage to the equipment.

Please fill in the information below. You will find the information on the machine identification plate. You will need this information when ordering replacement parts or making technical inquiries.

No part of this manual may be duplicated, reproduced, stored in a retrieval system, translated, transcribed, or transmitted in any form without the express prior written permission of Sealer Sales.

---

### WHA EQUIPMENT INFORMATION

---

❖ Model #

---

❖ Serial #

---

❖ Purchase Date:

---

❖ Reference # (found on packing slip)

---

❖ Owner:

---

# Safety Instructions

---



**WARNING!** Below are general safety precautions and warnings that should be understood prior to setting up or operating your equipment. Read and fully understand all instructions and warnings prior to using this unit. Your safety is most important! Failure to comply with procedures may result in serious injury or property damage. Remember: **Your personal safety is your responsibility.**

Unsafe practices or unauthorized modifications could result in accidents or property damage. Failure to follow these safety rules and take necessary precautions can result in serious injury as well as damage to equipment.

- ❖ Never operate or service your sealer until you have read this manual completely and understand it fully.
- ❖ Plug the sealer into a standard 120 Volt, 60Hz wall outlet or surge protector.
- ❖ Do not use the sealer if the power cord, plug or any other parts are damaged. Be sure not to allow the power cord to drape into your work area. Check that all parts are operating properly and perform the intended functions. Check for any worn parts before starting operation. Check for all other conditions that may affect the operation.
- ❖ Reduce risk of unintentional starting. Make sure the power switch is in the "OFF" position before attaching to the power source.
- ❖ Always disconnect sealer from power source before servicing, changing accessories or cleaning the unit.
- ❖ To provide protection against the risk of electrical shock, the power connection must be properly grounded at all times.
- ❖ Do not leave the sealer unattended when in use. Disconnect the sealer from the power source before leaving the work area.
- ❖ Sealer is used solely for sealing thermoplastic materials. Using the machine for any other purpose can cause damage to the machine and operator.
- ❖ While operating machinery, wear close-fitting clothing and tie back long hair to prevent any external items from getting caught in the machine. Do not wear jewelry when operating the sealer.



- ❖ Never touch the heating elements with bare hand while the sealer is plugged into a power source, in operation or just finished operation. Touching heated areas may cause fire and/or severe burns.

## WHA INSTRUCTION MANUAL

- ❖ While machine is in operation, do not place fingers, tools, or other foreign objects on or into the machine. Do not place hands or fingers near pinch points. Do not touch machine while it is operation. Perform all procedures carefully and watch where hands and fingers are at all times.
- ❖ The sealer is not water resistant or water proof. Spraying down the machine will damage machine or cause electrical shock. Do not submerge the sealer into water or liquid.
- ❖ Do not operate sealer in a corrosive or humid environment.
- ❖ Always keep the machine clean, lubricated and in good working condition. Follow any maintenance and lubrication procedures outlined in this manual. Make sure unit is disconnected from power source before cleaning.
- ❖ NEVER use any accessories or parts from other manufacturers. Machine should not be altered or modified using parts that are not genuine authorized parts. Doing so will VOID YOUR WARRANTY.
- ❖ Never leave the sealer unattended. Be safe, disconnect the sealer from power source before leaving work area.
- ❖ Always keep out of reach of children and pets.
- ❖ Close supervision is necessary when any machine is near persons with reduced physical, sensory or mental capabilities or lack of experience and knowledge . This sealer is NOT to be used by children or by persons with reduced physical, sensory or mental capabilities or lack of experience and knowledge.
- ❖ Do NOT use the sealer outdoors.
- ❖ Do NOT use the sealer while under the influence of drugs, medications or alcohol.

**SAVE THESE INSTRUCTIONS - REFER TO THEM OFTEN AND USE THEM TO INSTRUCT OTHERS.**

# Introduction

---

W-Series automatic sealers are ideal for high volume continuous poly bag and other thermoplastic sealing. The sealer allows you to keep both hands free for quicker and more accurate sealing. Our W-Series auto sealers can seal polyethylene, polypropylene, saran, nylon, static shielding bags, Mylar up to 30mil in total thickness depending on the model # of the sealer.

## Features of the W-Series Automatic Sealers

*Your automatic sealer is equipped with a wide range of standard features and capabilities.*

- ❖ Simple to use - no operator training needed
- ❖ Impulse sealing - no warm up time needed
- ❖ Dual mode operation: auto or manual
- ❖ Foot switch allows hands free operation
- ❖ Die cast construction
- ❖ 3 separate control settings for sealing time, recycle time, and congealing time
- ❖ Includes electric foot switch and adjustable work table
- ❖ Equipped with either 2.7mm, 5mm, or 10mm seal widths
- ❖ Option: double impulse sealing with heat on both sealing bars for sealing thicker materials
- ❖ Manufacturer spare parts kit includes: 2 heating elements

## How Do W-Series Automatic Sealers Work?

### Basic

### Principles

Place material on lower jaw and activate footswitch

Our W-Series automatic impulse sealers fire a short burst of electricity through a specially designed heating wire to weld thermoplastic materials together. The length of the seal time will depend on the sealing characteristics of the bag being sealed. The sealing process is simple: The operator places the bag between the sealing jaws and presses the footswitch to activate the unit. The sealer is equipped with a display for sealing and cool timer settings. The seal process ends automatically once the preset seal time is reached. The operator retrieves the sealed bag and repeats the process. Bags are sealed repeatedly and uniformly. When unit is on auto mode, sealing process will complete automatically without footswitch activation based on operator's recycle time settings.

## Specifications - Single Impulse Sealing

Single impulse automatic sealers are equipped with one heating element (lower sealing jaw).

	<b>W-300A</b>	<b>W-450A</b>	<b>W-600A</b>	
	<b>W-305A</b>	<b>W-455A</b>	<b>W-605A</b>	<b>W-755AA</b>
	<b>W-3010A</b>	<b>W-4510A</b>	<b>W-6010A</b>	
Power	110V/60Hz			
Watts	450W 600W 1000W	600W 800W TBD	800W 1300W TBD	1200W
Seal Width	2.7mm 5mm 10mm	2.7mm 5mm 10mm	2.7mm 5mm 10mm	5mm
Sealing Length	12"	18"	24"	30"
Net Weight	40lbs 42lbs 43lbs	45lbs 45lbs 46lbs	49lbs 53lbs 54lbs	79lbs
Dimensions	17" x 14" x 8"	21" x 14" x 8"	27" x 14" x 8"	33" x 14" x 10"
Gross Weight	47lbs 48lbs 49lbs	51lbs 51lbs 53lbs	55lbs 61lbs 62lbs	82lbs
Shipping Dimensions	25" x 19" x 13"	25" x 19" x 13"	31" x 20" x 13"	38" x 21" x 4"

## Specifications - Special Order Automatic Sealers

Our special order automatic sealers are equipped with double or triple electromagnets.

	<b>W-905AA</b>	<b>W-1205AAA</b>	<b>W-1505AAA</b>
Power	110V/60Hz	110V/60Hz	110V/60Hz
Watts	2948W	4125W	4290W
Seal Width	5mm	5mm	5mm
Sealing Length	35"	47"	59"
Net Weight	88lbs	104lbs	123lbs
Dimensions	39" x 15" x 10"	51" x 15" x 10"	63" x 15" x 10"
Gross Weight	90lbs	106lbs	126lbs
Shipping Dimensions	45" x 21" x 14"	56" x 21" x 14"	67" x 21" x 14"

## Specifications - Double Impulse Sealing

Single impulse automatic sealers are equipped with two heating elements (upper and lower) to fuse materials from both sides at the same time allowing thicker materials to be sealed.

	W-305AT	W-455AT
Power	110V/60Hz	110V/60Hz
Watts	1210W	2640W
Seal Width	5mm	5mm
Sealing Length	12"	18"
Net Weight	43lbs	49lbs
Dimensions	17" x 14" x 8"	21" x 14" x 8"
Gross Weight	50lbs	55lbs
Shipping Dimensions	25" x 19" x 13"	25" x 19" x 13"



# Getting to Know your Automatic Sealer

W-Series Foot Sealers are simple and efficient sealing machines.

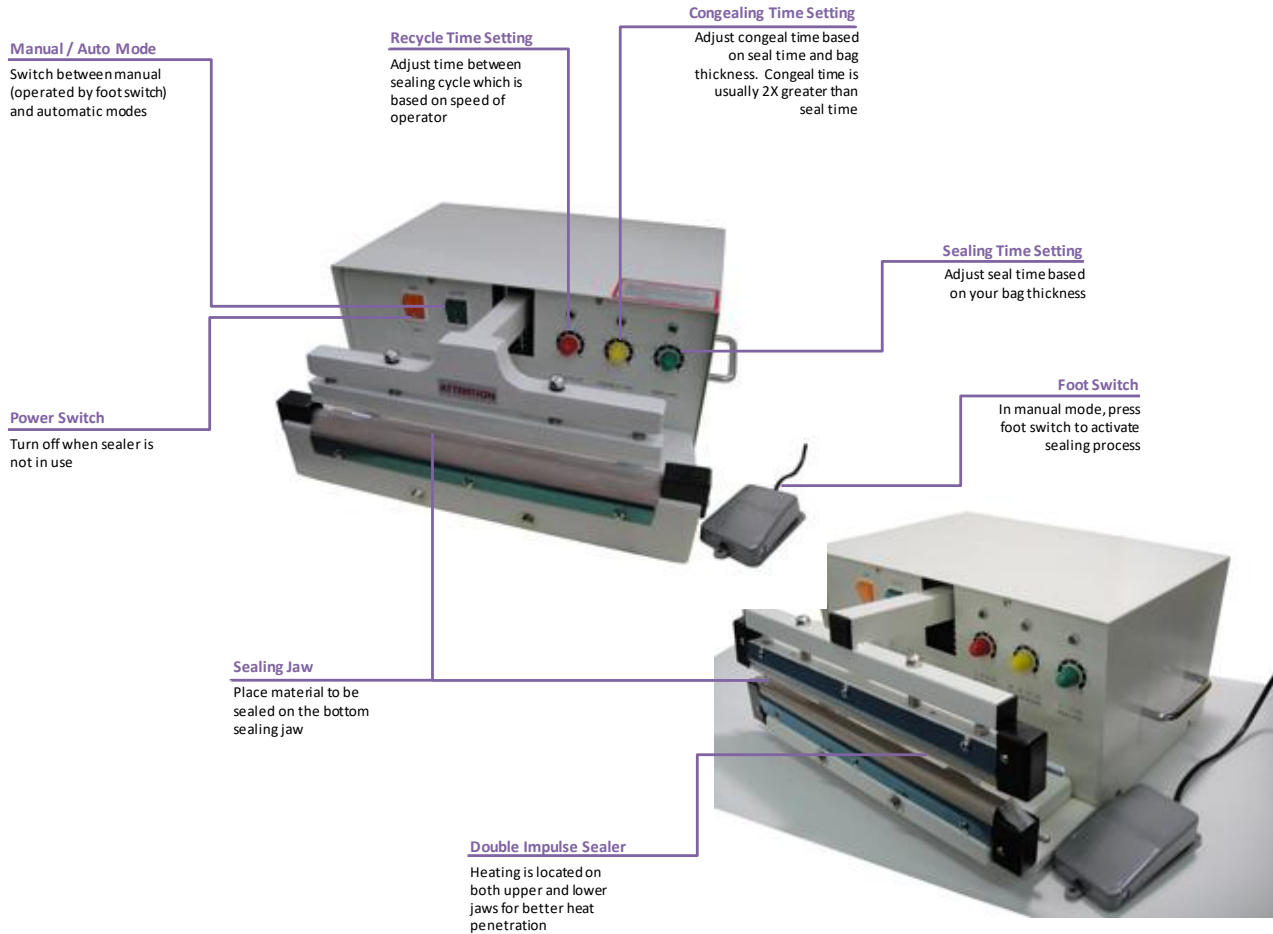

Figure 1. W-Series Automatic Sealer Overview

# Electric Connection Diagram

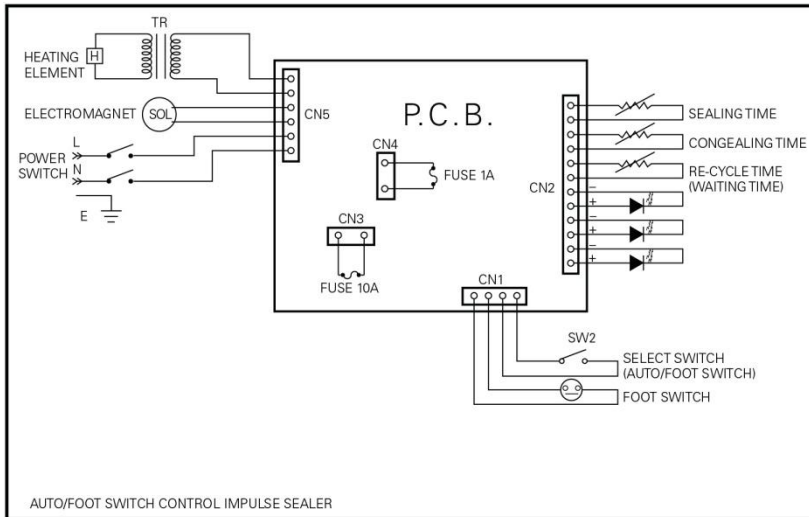

Figure 2. W-Series Automatic Sealers Electric Connection Diagram

# Operating your Sealer

---

## Assembly Instructions

1. Connect the footswitch to the sealer unit.
2. To install the optional working plate and table, remove screws located at the front of the unit and install the working plate. Adjust working table height according to your bag specifications.

## Operation



1. Before operating, check the heating element, PTFE cover, PTFE adhesive and the silicone rubber.
2. Insert the power cord into the correct receptacle (110V).
3. Turn the power switch on.
4. Choose the appropriate mode: manual or auto. Press the green switch towards MAN for manual mode and press the switch towards AUTO for automatic mode
  - a. For manual operation, place the material to be sealed on the lower sealing jaw and press the foot switch to activate the upper sealing jaw.
  - b. For auto operation, press the switch towards AUTO to activate automatic sealing. To turn off the automatic mode and return to manual mode, press the switch towards MAN. Auto mode enables the upper sealing jaw to open and close automatically based on the sealing, cooling and recycle settings.
5. Set the SEALING knob to the lowest setting. Always start with a low setting and increase gradually as needed. Thicker bags will need a higher setting.
6. Set the CONGEALING knob setting. The cooling (congeal) setting button determines the congealing time for the sealing. For a high quality seal, seals must be able to cool under pressure. We usually recommend a congeal setting of at least 2x that of the seal setting, but every bag will have variations. Thicker materials will require a longer cool (congealing) time.
7. Set the RECYCLE knob setting. Recycle time determines the amount of time the sealing/congealing cycle will reset.. Recycle time is based on the working speed of the operator.

## Tips for Successful Sealing

1. If the seal is broken or damaged, decrease the sealing time.

2. If the seal is not fully welded, increase the sealing time.
3. If the sealing material sticks to the sealing pad, decrease the congealing time.
4. If the width of the seal is not perfect or does not match the size of the element, increase the congealing time.
5. Always keep the sealer clean. Remove any residue found on the platform and PTFE cover. Silicone spray may be used for this purpose.



6. ***When replacing the heating elements, always replace the PTFE adhesive under the heating element. A worn PTFE adhesive can cause the heating element to break.*** The PTFE adhesive works as a barrier between the body of the sealer and the element. Never allow the element to come in direct contact with the sealer body as that will damage the timer.
7. Occasionally check the condition of the silicone rubber for wear or burns. A damaged silicone rubber will affect the quality of the seal.



8. Be sure to turn off the power or unplug the unit before replacing any parts.

# Maintenance

The following maintenance procedures should be followed to ensure the longevity of your W-Series automatic sealer.

## Inspection and Cleaning

1. Inspect your machine daily.
2. Use a clean cloth to remove any plastic residue remaining on the PTFE cloth.
3. When replacing the elements, always check the condition of the bottom PTFE tape.
4. Check the condition of the silicone rubber for wear and burns. A damaged silicone rubber will affect the quality of the seal.

## Replacement Kit Instructions

Our W-Series automatic sealers will require new heating elements and PTFE from time to time. Heating elements will break through wear and tear. A good rule of thumb is to replace the PTFE adhesive every time you change your heating element. The PTFE cover prevents the plastic or other thermoplastic material you are sealing from sticking to the heating element.

Replacement kits are available from your distributor.

For single impulse automatic sealers, kits include (2) heating elements, (2) PTFE adhesives, and 1ft long roll of PTFE cover. For replacement kit part #s, refer to your model #. **\*\*Please note that heating elements and kits are NOT interchangeable with one another.\*\***

	W-300A	W-450A	W-600A	
	W-305A	W-455A	W-605A	W-755AA
	W-3010A	W-4510A	W-6010A	
Replacement Kit (2.7mm)	RK-12A-W-300A	RK-18A-W-450A	RK-24A-W-600A	
Replacement Kit (5mm)	RK-12A5-W-305A	RK-18A5-W-455A	RK-24A5-W-605A	RK-30A5-W-755AA
Replacement Kit (10mm)	RK-12A10-W-3010A	RK-18A10-W-4510A	RK-24A10-W-6010A	
Heating Element (2.7mm)	HE-12-2.7-W-300A	HE-18-2.7-W-450A	HE-24-2.7-W-600A	
Heating Element (5mm)	HE-12-5-W-305A	HE-18-5-W-455A	HE-24-5-W-605A	HE-30-5-W-755AA
Heating Element (10mm)	HE-12-10-W-3010A	HE-18-10-W-4510A	HE-24-10-W-6010A	
PTFE Adhesive	TA-12	TA-18	TA-24	TA-30
PTFE Cloth	TR-12-12	TR-18-12	TR-24-12	TR-30-12
Silicone Rubber (not included in RK)	SR-W-300A	SR-W-450A	SR-W-600A	SR-W-755AA

For double impulse automatic sealers, kits include (2) heating elements, (2) PTFE adhesives, and 2ft long roll of PTFE cover. For replacement kit part #s, refer to your model #. **\*\*Please note that heating elements and kits are NOT interchangeable with one another.\*\***

	W-305AT	W-455AT
Replacement Kit	RK-12AD-W-305AT	RK-18AD-W-455AT
Heating Element (5mm)	HE-12-5-W-305A	HE-18-5-W-455A
PTFE Adhesive	TA-12	TA-18
PTFE Cloth	TR-12-12	TR-18-12
Silicone Rubber (not included in RK)	SR-W-300A	SR-W-450A

To install your replacement kit on your sealer, turn off power and unplug sealer.

### Removing Worn Parts.

1. Loosen the screws on the PTFE cover plate (Figure 10, Item #16).
2. Remove the heating element cover.



Figure 3. Loosen screws on PTFE plate.

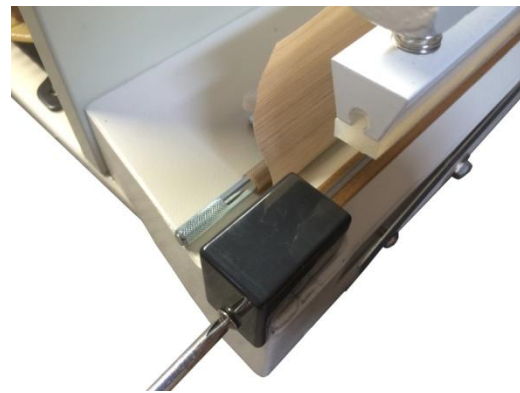

Figure 4. Remove heating element cover

3. Lift up the PTFE cover to expose the heating element (Figure 10, Item #19).
4. Unscrew the nut on the mounting spring (Figure 10, Item #23-2). Remove the heating element by lifting off the eyelets of the heating element from the mounting spring on both ends.

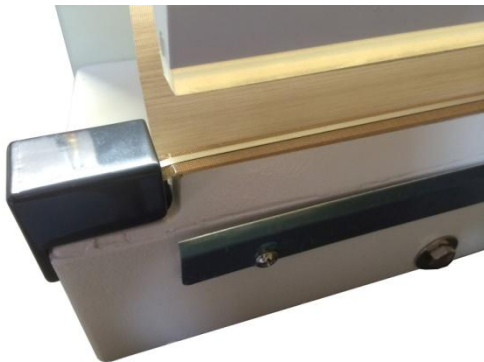

Figure 5. Lift up the PTFE cover to expose the heating element

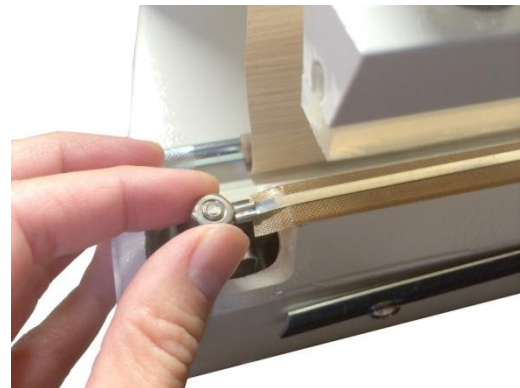

Figure 6. Remove heating element cover

5. Peel off the PTFE adhesive under the heating element.

## Installing New Replacement Parts.

1. Remove the backing of the liner found on the PTFE adhesive.
2. Apply it to the sealer's sealing platform. The PTFE adhesive must always extend past the sealing platform by approximately ¼" to ½" on both ends. Bend down the excess on both ends. (The PTFE adhesive acts a barrier between the metal body and the heating element. Never allow the heating element to come in direct contact with the sealer's body because it will damage the timer.)
3. Place a new element on top of the PTFE adhesive by fitting one eyelet of the heating element on one mounting spring followed by the other mounting spring. Using a screwdriver to flex the mounting spring inward will ease the placement of the element on the mounting spring. Check the elements to ensure it is tight and intact.
4. Cut off any worn out PTFE cover. Ease out enough footage of PTFE cover to cover the heating element and extend to the front of the PTFE cover plate.
5. Tighten the screws to affix the PTFE cover plate.
6. If a whole roll of PTFE cover needs to be replaced, loosen the multi-star knob (**Figure 10, Item #15**) found on the plate for PTFE (**Figure 10, Item #14**) and remove the PTFE cover roller (**Figure 10, Item #18**). Tape one end of the PTFE cover to the rod and roll up the entire piece. Position the PTFE cover and rod using the plate for PTFE. Ease out enough footage of PTFE cover to cover the heating element and extend to the front of the PTFE cover plate.



**Figure 7.** Loosen multi-star knob to remove the PTFE roller.

## Microswitch Adjustment

Sometimes the microswitch (also called the trigger switch) is moved out of alignment (during shipment or sharp movements) and needs a simple adjustment to get the unit back to proper working order.

### Check for the "Click"

The microswitch activates the electrical current to heat the element. When the sealing arm meets the base of the sealer, the microswitch will activate. User should hear the "click" of the microswitch activation. If the "click" is intermittent, this means the microswitch is not triggered and no electrical current is passing through.

### How to Make Adjustments



1. Before operating, turn off unit and unplug.
2. Locate the microswitch which is located at the front of the body. Carefully remove the cover in order to access the microswitch.

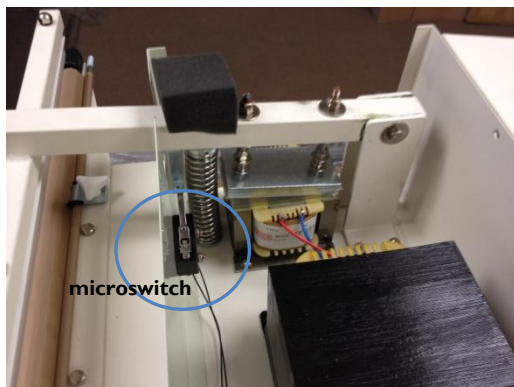

Figure 8. Microswitch is found at the front of the body.

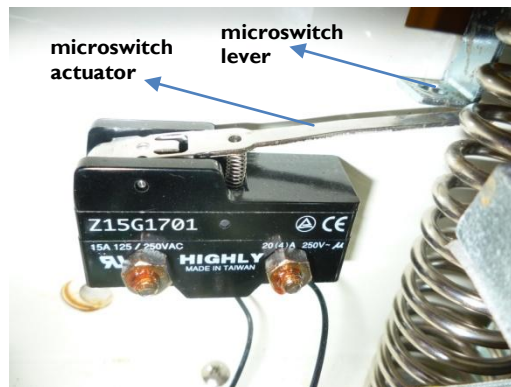

Figure 9. Microswitch position

3. Make sure the microswitch is screwed tightly to base. If not tighten.
4. Make sure the microswitch lever touches the middle of the microswitch actuator
5. Make sure the microswitch actuator is **underneath** the microswitch lever. Sometimes the microswitch actuator moves above the microswitch lever during shipping.



# Parts Diagram

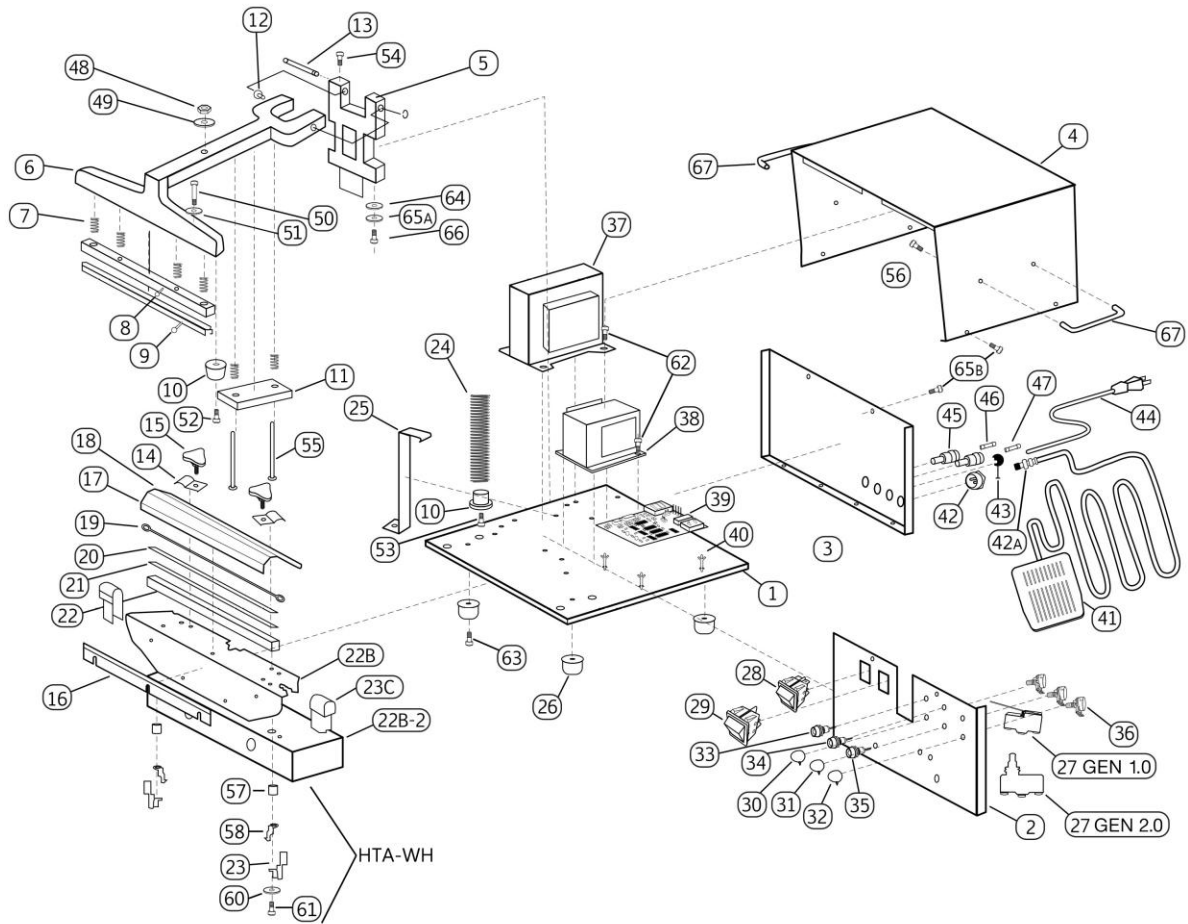

Figure 10. Spare Parts Diagram Overview

Figure 11. Spare Parts Diagram Overview

Item	Part #	Description	Comments
RKs	RK-Model#	<b>REPLACEMENT KITS</b> Includes (2) elements, (2) PTFE adhesives, and 1ft PTFE cover (2ft if double impulse)	specify model # when ordering
1		Bracket / Base	
2	WHA-2	Control Plate / Front Panel	
3	WHA-3	Rear Plate	
4	WHA-4	Cover	
5	WHA-5	T-Type Bracket	
6		Upper Jaw	specify model # when ordering
7	WHA-7	Spring, Small, Silicone Bracket (WHA, WHLF)	
8		Silicone Bracket	specify model # when ordering
9	SR-specifymodel#	Silicone Rubber	
10	WHA-10	Spring Bracket	
11	WHA-11	Sucking Plate	
12	WHA-12	Bushing / Pin Washer	
13	WHA-13	Shaft / Hinge Pin	
14	WHA-14	Plate for PTFE Sheet (Clip) (W-Series)	
15	WHA-15	Multi Star Knob (W-Series)	
16		PTFE Cover Plate	specify model # when ordering
17	TR-specifymodel#	PTFE Cover Roll	specify model # when ordering
18		PTFE Cover Roller (Iron Stick)	specify model # when ordering
19	HE-specifymodel#	Heating Element	specify model # when ordering
20	TA-specifymodel#	PTFE Adhesive (Insulated Tape), 6mil	specify model # when ordering
21	WHLH-49	Fiber Plate - 1.2m (47") - cut to fit	
22		Aluminum Bracket	specify model # when ordering
23	MS-WHA	Spring Hook, Mounting	
23b	HTA-WH	Heater Element Assembly Includes Parts #23,57,58,59,60,61	
	HTAB-WH	Heating Terminal Assembly Block	model #s W-305AT, W-3010A, W-455AT, W-455AT
23c	WHLH-36	Cover for Heating Element (Screw - WHLH-61) (WHA and WHLH)	
	HTABwCover-WH	Heating Terminal Assembly Block w/ Cover	model #s W-305AT, W-3010A, W-455AT, W-455AT
24	WHA-24	Spring, Big	
25		Stop Plate	
26	WHA-26	Rubber Mat / Rubber Foot	
27 - Gen 1.0	MSW-WHA	Microswitch / Arm - Gen 1.0	
27 - Gen 2.0	MSW-WHF	Microswitch / Arm - Gen 2.0	
27a	WHA-27A	Microswitch Plates (new gen - 2013)	
28	WHA-28	Power Switch (R), 4P Orange (On/Off)	
29	WHA-29	Power Switch (G), 6P Green (Manual/Auto)	
30	WHA-30	Knob, Red for (W-Series)	
31	WHA-31	Knob (Y), Yellow	
32	WHA-32	Knob (G), Green	
33	WHA-33	Lamp (R), LED for E.G.O. E-00302 for (W-Series)	
34	WHA-34	Lamp (Y), LED / Lamp (O)	
35	WHA-35	Lamp (G), LED	
36	WHA-36	Variable Resistor - 1M (W-Series)	

**Figure 12. Spare Parts Diagram Overview**

Item	Part #	Description	Comments
37	<b>TRNS-specifymodel#</b>	Transformer	<b>specify model # when ordering</b>
38	<b>Solenoid-WH</b>	Solenoid (Electromagnet) TF-281 (2 for AA models)	
39	<b>WHA-39</b>	PC Board, w/ 25A Relay	
40	<b>WHA-40</b>	Pin for PC Board	
41	<b>FSW-WH</b>	Foot Switch	
42	<b>TISA-39</b>	Foot Switch Connect at Sealer	
42a	<b>TISA-30c</b>	Foot Switch Connect at Foot Switch	
43	<b>WHA-43</b>	Grommet (W-Series)	
44	<b>PC-WH</b>	Power Cord PC-WH	
45	<b>WHA-45</b>	Fuse Holder	
46	<b>WHA-46</b>	Fuse (1A)	
47	<b>Fuse-7amp</b>	Fuse (7A)	<b>for W-300A</b>
47a	<b>Fuse-10amp</b>	Fuse (10A)	<b>for W-305A / W-450A</b>
47b	<b>Fuse-15amp</b>	Fuse (15A)	<b>for W-455A / W-600A</b>
47c	<b>Fuse-20amp</b>	Fuse (20A)	<b>for W-605A</b>
48		Nut 1/4	
49		Washer 1/4 x 1 x 16	
50	<b>WHA-50</b>	Hex Cap Screw 5/16 for #8	
51	<b>WHA-51</b>	Washer	
52	<b>WHA-52</b>	Hex Cap Screw 1/4x1 for #10	
53		Screw 4x25	
54	<b>WHA-54</b>	Screw #54 for Shaft/Hinge Pin (includes nut and washer)	
55	<b>WHA-55</b>	Screw 1/4x3 1/4 for #11	
56	<b>Screw-M4x8</b>	M4*8 Screw	
57	<b>WHA-57</b>	Washer (R)	
58	<b>WHLH-42</b>	Solderless Terminal 2-8 / Connecting Plate	
59	<b>WHA-59</b>	Bushing (BK), Convex	
60		Washer 3/16	
61		Screw 3/16x1/2	
62		Screw 5x8	
63	<b>WHA-63</b>	Screw 5x15 - For Rubber Foot	
64	<b>WHA-64</b>	Washer 3/8x2x24 for #5	
65A	<b>WHA-65</b>	Spring Washer 3/8 for #5	
65B		Screw for Cover of Sealer (side)	
66	<b>WHA-66</b>	Hex Cap Screw 3/8x3/4 for #5	
67	<b>WHLH-9</b>	Handle (metal) for WHLH and WHA	
70	<b>WHDF-20</b>	Working Plate	
70a	<b>WHDF-19A</b>	Working Adjusting Plate Screw Set - (Includes: 2-screws, 4-washers, and 2-wing nuts)	
70b	<b>WHDF-20A</b>	Working Plate Screw Set - WHA, WHDF	
71	<b>WHDF-19</b>	Working Adjusting Plate - 6 1/4" x 9 1/2" (W x L)	

# Troubleshooting

Problem	Possible Causes	Solution
No sealing or power Sealing jaws cannot activate	<ol style="list-style-type: none"> <li>1. Disconnected power cord</li> <li>2. Power cord is broken</li> <li>3. Blown fuse</li> <li>4. On/Off switch worn out</li> <li>5. Transformer worn out</li> </ol>	<ol style="list-style-type: none"> <li>1. Check or change plug</li> <li>2. Replace power cord (Part#PWC-WH)</li> <li>3. Replace fuse</li> <li>4. Replace on/off switch (Part #WHA-28)</li> <li>5. Replace the transformer (Part#TRNS-model#)</li> </ol>
No sealing On/Off switch light is on Sealing light on	<ol style="list-style-type: none"> <li>1. Heating element is broken</li> <li>2. Poor contact at mounting spring</li> <li>3. Terminals of heating element do not make good contact</li> </ol>	<ol style="list-style-type: none"> <li>1. Replace the heating element and PTFE adhesive under the element</li> <li>2. Clean, tighten or change mounting spring</li> <li>3. Clean terminals and adjust if necessary</li> </ol>
No sealing On/Off switch light is on Sealing light off	<ol style="list-style-type: none"> <li>1. Microswitch not activated</li> <li>2. Microswitch worn out</li> </ol>	<ol style="list-style-type: none"> <li>1. Adjust microswitch lever of microswitch position</li> <li>2. Replace microswitch</li> </ol>
No sealing Sealing jaws remain closed	<ol style="list-style-type: none"> <li>1. Solenoid worn out</li> </ol>	<ol style="list-style-type: none"> <li>1. Replace solenoid (Part#Solenoid-WH)</li> </ol>
Auto mode is fine Manual mode does not work	<ol style="list-style-type: none"> <li>1. Footswitch worn out</li> </ol>	<ol style="list-style-type: none"> <li>1. Replace footswitch (Part#FS-WH)</li> </ol>
Burnt PTFE cloth	<ol style="list-style-type: none"> <li>1. Timer malfunction</li> <li>2. Timer setting too high</li> </ol>	<ol style="list-style-type: none"> <li>1. Replace timer</li> <li>2. Decrease timer setting</li> </ol>
Broken heating element	<ol style="list-style-type: none"> <li>1. Worn bottom PTFE adhesive</li> </ol>	<ol style="list-style-type: none"> <li>1. Replace bottom PTFE adhesive</li> </ol>
Wrinkled seal	<ol style="list-style-type: none"> <li>1. Seal time is set too high</li> <li>2. Cooling (congeal) time is too short</li> </ol>	<ol style="list-style-type: none"> <li>1. Decrease</li> <li>2. Increase congealing time</li> </ol>
Imperfect seal	<ol style="list-style-type: none"> <li>1. Worn PTFE cloth</li> <li>2. Worn silicone rubber</li> </ol>	<ol style="list-style-type: none"> <li>1. Replace PTFE cloth</li> <li>2. Replace the silicone rubber</li> </ol>
Burnt seal	<ol style="list-style-type: none"> <li>1. Seal time is set too high</li> </ol>	<ol style="list-style-type: none"> <li>1. Decrease seal time</li> </ol>
No seal	<ol style="list-style-type: none"> <li>1. Seal time is set too low</li> </ol>	<ol style="list-style-type: none"> <li>1. Increase seal time</li> </ol>
Seal sticking to PTFE adhesive	<ol style="list-style-type: none"> <li>1. Worn or dirty PTFE cloth</li> <li>2. Worn or dirty silicone rubber</li> </ol>	<ol style="list-style-type: none"> <li>1. Replace or clean PTFE cloth</li> <li>2. Replace or clean silicone rubber</li> </ol>