



Ice Machine ***USER MANUAL***



Model 243027



Model 243028
Model 243029
Model 243030



Intertek



Intertek

Read this manual thoroughly prior to installation and operation.

Keep these instructions in a safe location for future reference.

For questions, contact NEXEL® Customer Service at 1-800-245-6682

or visit www.nexelwire.com

Safety Information

WARNING:

Pay careful attention to the following warning labels on the ice maker.

HAZARDOUS VOLTAGE:

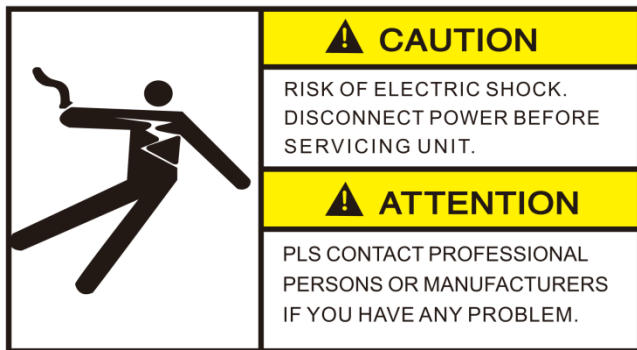

The label indicates a hazardous voltage. There is a risk of electric shock.

HAZARDOUS VOLTAGE:

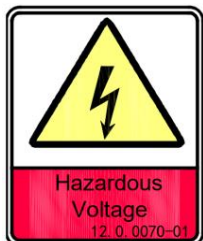

The label indicates a hazardous voltage. There is a risk of electric shock.

ROTATING COMPONENTS WARNING:

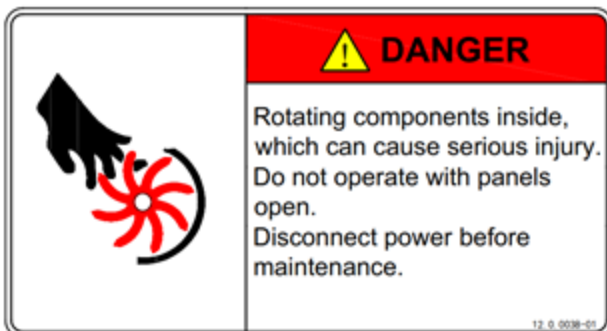

The label indicates rotating components inside. There is a risk of serious mechanical injury.

FIRE HAZARD:



The label indicates a flammable foaming agent "Cyclopentane" used. There is a risk of fire.

FIRE HAZARD:



R290

The label indicates a flammable refrigerant "R290" used. There is a risk of fire.

Safety Information (continued)

 **DO NOT use this product in outdoor environments.**

 **DO NOT allow children, or those with physical or mental imparities play or operate this machine.**

- ◆ The installation, repair or maintenance of this ice machine must be carried out by professional and qualified personnel, or electric shock, fire, personal injury may cause from incorrect operation.
- ◆ After the ice machine is delivered, please keep the machine sit upright for 24 hours, to have the lubricant be fully precipitated before startup, otherwise the compressor may be damaged.
- ◆ DO NOT invert the machine or lay it horizontally. When handling, keep the cabinet upright, with the inclination not exceeding 45 degrees.
- ◆ DO NOT place the ice machine in wet areas or where water can easily be splashed onto the unit.
- ◆ The grounding of this ice machine cannot be connected to gas pipe, water pipe, telephone line or lightning rods, etc.
- ◆ To avoid serious injury, or mechanical issues, DO NOT insert fingers, or any objects into the ventilation or exhaust ports of this machine.
- ◆ DO NOT store volatile or flammable substances in this ice machine, or it may result in explosion or fire.
- ◆ DO NOT store objects, or freeze any food in the ice bin. Keep the ice scoop clean.
- ◆ The ice machine must be placed on the floor sufficient to supports its weight. Insufficient base may cause the equipment fall over and cause injury.
- ◆ There should be sufficient ventilation space around the ice machine. Keep good ventilation.
- ◆ Only the power supply specified on the machine nameplate can be used with this ice machine.
- ◆ DO NOT connect the ice machine to hot water.
- ◆ Socket for this ice maker must be reliably grounded and with leakage protection.
- ◆ The ice machine must be disconnected from power before manual cleaning, repairing and maintenance.
- ◆ Before cleaning, repairing and maintenance, the remaining ice in the ice bin should be to avoid contamination.
- ◆ DO NOT splash water directly onto the surface of the ice machine during the cleaning process; otherwise it may cause a short circuit, leakage or other faults.
- ◆ Flammable foaming agent is used during the foaming process. The ice maker should be disposed of and recycled by qualified personnel and institutions.
- ◆ The ice machine should be properly managed to ensure that children will not play with the machine.
- ◆ If there are any malfunctions, turn off the power to the unit and contact professional personnel for repair.



R290

WARNING: This ice maker contains a flammable refrigerant R290/R404a:

- DANGER – RISK OF FIRE OR EXPLOSION. FLAMMABLE REFRIGERANT USED. DO NOT USE MECHANICAL DEVICES TO DEFROST REFRIGERATOR. DO NOT PUNCTURE REFRIGERANT TUBING.
- DANGER – RISK OF FIRE OR EXPLOSION. FLAMMABLE REFRIGERANT USED. TO BE REPAIRED ONLY BY TRAINED SERVICE PERSONNEL. DO NOT PUNCTURE REFRIGERANT TUBING.
- CAUTION – RISK OF FIRE OR EXPLOSION FLAMMABLE REFRIGERANT USED. CONSULT

REPAIR MANUAL/OWNER'S GUIDE BEFORE ATTEMPTING TO SERVICE THIS PRODUCT. ALL SAFETY PRECAUTIONS MUST BE FOLLOWED.

- CAUTION – RISK OF FIRE OR EXPLOSION. DISPOSE OF PROPERLY IN ACCORDANCE WITH FEDERAL OR LOCAL REGULATIONS. FLAMMABLE REFRIGERANT USED.
- CAUTION – RISK OF FIRE OR EXPLOSION DUE TO PUNCTURE OF REFRIGERANT TUBING; FOLLOW HANDLING INSTRUCTIONS CAREFULLY. FLAMMABLE REFRIGERANT USED.

General

The ice machine is fully automatic. With proper installation and connection to potable water and power source, the ice making

process will automatically operate. When the bin is completely filled with ice, the machine will automatically stop.

Installation

Location for Installation

The ice machine must be installed in a proper location meeting the following conditions:

- Indoor, not more than 6,500 ft. above sea level;
- Ambient temperature: 41-104°F (5-40°C);
- Power supply: the rated voltage indicated on the machine nameplate $\pm 6\%$;
- Water source: potable water, with water pressure from 1.3 Bar to 5.5 Bar; water temperature: 41-95°F (5-35°C);
- Keep ice machine away from heat sources. DO NOT use in extreme high or low temperature environments. Avoid direct sunlight.

- Leave sufficient ventilation space around the ice machine and keep good ventilation. The distance from the ice maker to the wall must be no less than 12" from the front, 8" from the rear, and 6" from each side.
- The ice machine must be placed on a floor sufficient to support its weight;
- Socket for the ice maker must be reliably grounded and with leakage protection;
- Proper floor drainage must be provided near the installation location of the ice machine.



Specifications:

Model	243027	243028	243029	243030
Voltage:	115/60 (V/Hz)	115/60 (V/Hz)	115/60 (V/Hz)	115/60 (V/Hz)
Power:	446W	451W	526W	726W
Bin Capacity:	40 lbs.	80 lbs.	80 lbs.	80 lbs.
Output:	120 lbs/24 hr.	160 lbs/24 hr.	210 lbs/24 hr.	251 lbs/24 hr.
Refrigerant:	R290	R290	R290	R290
Cooling:	Air Cooled	Air Cooled	Air Cooled	Air Cooled
Certification:	Energy Star, ETL/ cETL ETL Sanitation	Energy Star, ETL/ cETL ETL Sanitation	Energy Star, ETL/ cETL ETL Sanitation	Energy Star, ETL/ cETL ETL Sanitation
Dimensions:	19-3/4"W x 23-1/4"D x 36"H	26"W x 27-3/4"D x 38-1/2"H	26"W x 27-3/4"D 38-1/2"H	26"W x 27-3/4"D 38-1/2"H
Weight:	99.2 lbs.	121.3 lbs.	125.7 lbs.	132.3 lbs.
Warranty:	1 Year	1 Year	1 Year	1 Year

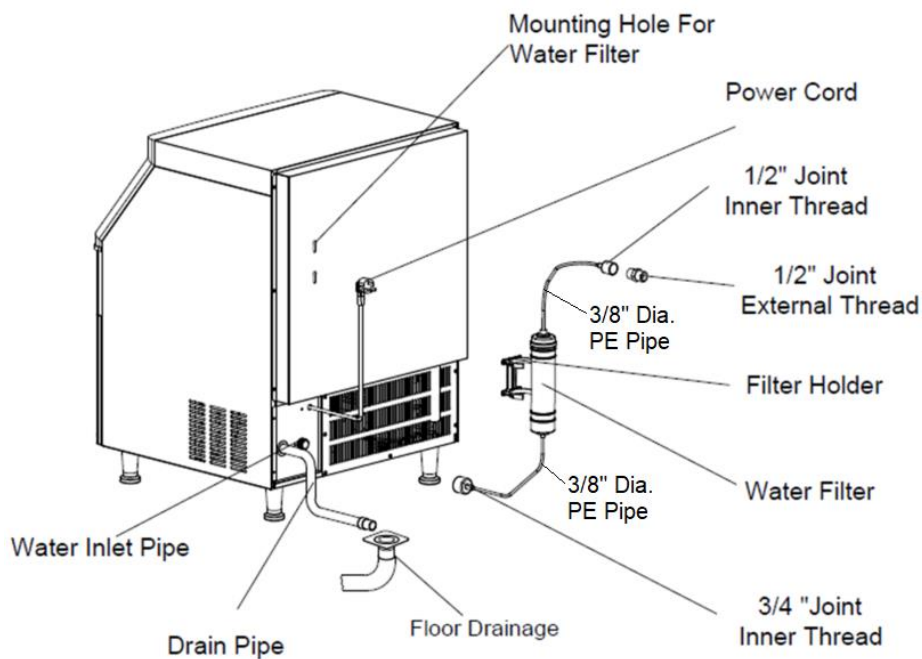
Schematic Diagram of Installation



Water Pipe and Drain Accessories:

Ref. No	Parts Name	Internal dia. (inches)	External dia. (inches)	Length (ft.)	Color	Picture
1	Inlet Water Pipe	2/8	3/8	6-1/2 ft.	White	  <p>*Filter not included</p>
		2/8	3/8	2 ft.	White	
3	Drain Pipe for Modular Ice Machine Head	6/8	1	5 ft.	Black	

Installation Steps

1. Upon delivery, check if the ice machine and all accessories are in good condition; check the machine model and the machine nameplate.
2. Open the bin door and remove the packaging tape from the ice thickness sensor and the flap. This is used to avoid possible damage during transportation.
3. Clean the ice bin and all areas inside with a sponge soaked in warm water. Then wash and dry it with potable water.
4. Place the ice machine in the operation area; ensure that the machine is placed on a leveled floor. So as to ensure the water flows evenly on the evaporator.
5. Good ventilation is required. Allow no less than 12" from the front, 8" from the rear, and 6" from each side of the unit to the wall.
6. The bottom of the ice machine is equipped with adjustable legs for level adjustment and floor cleaning.
7. Connect the machine's inlet water filter (not included) and water pipe referring to the schematic diagram of installation; if the installation site is already equipped with a drinking water system, a water filter may not be required.

 **NOTE: Filter not included.**

 **NOTE: The filter flow direction should be correctly installed as per the direction**

marker on the filter head cover or filter.

 **NOTE: This machine is to be used with inlet water filter (not included). The filter will keep impurities from the water used as the machine is running. Generally, filters should be replaced every month to 3 months depending on usage.**

8. Connect the machine to the water supply using the 3/8" inlet pipe supplied with the machine. It is recommended to install a water valve (not supplied with this machine) on the water supply line.
9. Make sure the drain pipe is not blocked with foreign debris, and then connect it to the drain connection. It is recommended that the drain pipe be connected to an open drainage port.
10. Any joint in the drain pipe must not be higher than the machine drainage port; and cannot be higher than the previous joint.
11. Confirm the power requirements stated in the machine nameplate; ensure that the power supply meets the requirements.
12. A circuit breaker or switch with leakage protector and reliably grounding is required.
13. Turn off the switch on the power line and connect the machine to the power source.

Startup and Operation

1. Before you start up the machine, check and confirm:
 - That the packaging tape inside the ice machine has been removed;
 - All accessories and items in the ice bin have removed;
 - The ice machine has been adjusted to a leveled state;
 - The water pipe has been connected and the water valve is open;
 - The plug has been connected to the power supply and the power switch is off;
 - The ambient temperature, water temperature, and pressure of the water supply meet the above requirements.
2. Start up: turn on the power switch. After the machine is powered-on, it will automatically begin to make ice.
3. For normal operation, check and confirm:

- ✓ There is water in the water trough and no overflow occurs;
- ✓ The pump is working properly and water is flowing evenly on the evaporator;
- ✓ The compressor is running normally, the temperature of the evaporator and the ice making water is gradually decreasing;
- ✓ For air cooled machine, check that the fan is running normally, and there is stable air flow in the inlet and outlet of the ice machine;
- ✓ The ice machine has no abnormal noise;
- ✓ The ice machine has no abnormal vibration;
- ✓ It takes about 10 to 20 minutes to make one batch of ice, depending on the ambient temperature and the temperature of the water. The higher the temperature is, the longer the ice making will take.

Operation Instruction

- **Startup:** After proper installation, connect the water source and turn on the power supply, the machine will start working.

⚠ Note: If the ice machine will not be used for a long time, disconnect the power and water source.

- **Self-Check:** Once powered on for the first time, the ice maker will do a self-check and pump out remaining water.
- **Preparing:** After the ice machine is energized, the inlet valve will open and water will enter the machine.
- **Ice Making:** After pre-cooling for approximately 30 seconds, the water pump will start, and water will flow through the evaporator smoothly and evenly, the ice cubes are gradually formed in the ice cube tray.

- **Ice Harvest (Drop):** After the ice making process, the water pump will turn off, and the defrost valve will turn on, allowing hot gas to enter the evaporator. The ice cubes slide from the evaporator into the ice bin.

⚠ WARNING: Keep hands away from ice bin during the harvest process, to prevent injury or contamination.

- **Shutdown:** The ice maker will stop working when you click the “on/off” button on the panel during running process.
- **Full Bin Auto-Stop:** Once the ice bin is filled to a predetermined height, the sliding board cannot reset and the ice maker will automatically stop. Once ice has been removed, the ice maker will turn back within a few seconds.

Instruction of Control Panel

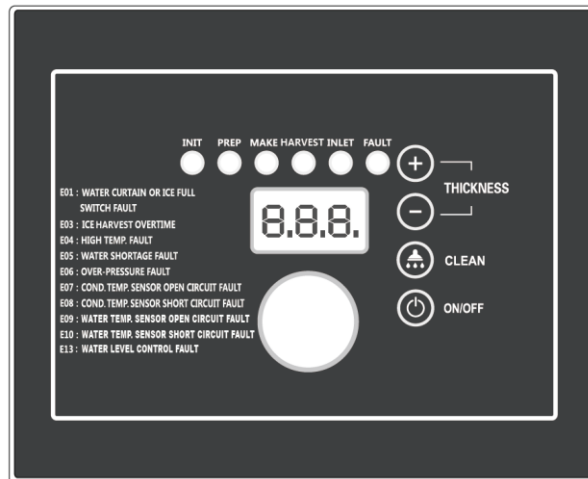

1. LED Display:

- Self-Check: Will display “INI” code.
- Preparing: Counts the number of seconds the machine takes to prepare.
- Ice Making: Counts the number of seconds the machine takes until the water temperature decreases to 32°F (0°C).
- Ice Harvest: Counts the number of seconds the machine is in ice harvest mode.
- Clean: Displays “CLE” during cleaning mode; Displays “STL” during sterilizing mode; Displays “RIN” during rinsing mode.

2. LED Lamps: Lights on during the related process.

3. Ice Cube Thickness Adjustment: If the default ice cube thickness needs adjustment, press the ice cube “-” button for 3 seconds, then tap the “+” or “-” buttons on the panel to adjust the thickness of the ice cube.

⚠ Note: By clicking the “+” or “-” button one time, the ice making time is extended or shortened by 1.5 minutes.

4. Cleaning: Press and hold the “CLEAN” button for 3 seconds to enter cleaning

mode. During this process, cleaning agents and disinfectants need to be put into the water trough. When the cleaning process is finished, the unit will enter the ice making process.

5. Switch: Click the “Switch” button power the device ON/OFF.

6. DO NOT slam the ice bin door; gently open and close it. Always close the ice bin door after each use.

7. If the ice maker is not being used for an extended period of time, it is recommended to power on and run the unit for 2 to 4 hours every 2 months.

Shutdown Protection

- If the ice machine has not detected ice cubes falling in three consecutive cycles, the machine will shut down for safety protection.

- The ice machine detects if the ambient temperature is too high and will stop for safety protection.

- If the water-cooled ice machine detects an abnormality in water supply, it will stop for safety protection.

Fault Codes:

Code	Comments	Work Mode
E01	Water Curtain or Ice Full Switch Fault	Sleeping mode and recover after the sliding board reset
E03	Ice Harvest Overtime	Sleeping mode
E04	High Temp. Fault	Sleeping mode

E05	Water Shortage Fault	Sleeping mode and retry every 30 mins
E06	Over-Pressure Fault	Sleeping mode
E07	Cond. Temp. Sensor Open Circuit Fault	Keep working
E08	Cond. Temp. Sensor Short Circuit Fault	Keep working

Maintenance

⚠ NOTE: Maintenance must be done by qualified professional personnel.

⚠ WARNING: Shut off the power supply and water source before cleaning or performing any maintenance.

Exterior Cleaning

- Frequently clean the environment around the ice machine to keep it clean. DO NOT block the vents.
- The outer enclosure should be cleaned with a mild detergent and then wiped clean. If necessary, use commercial stainless steel cleaners and polishes.

⚠ NOTE: Stainless steel may rust without proper maintenance.

Inlet Water Filter (not included)

- The filter element should be inspected regularly. It is recommended to replace filter element every month to every 3 months depending on usage.

Interior Cleaning

- The inside of the ice bin can be washed directly with water.

⚠ NOTE: Check and confirm the water pressure is lower than the maximum allowed pressure. DO NOT flush the part above the water pump or the evaporator directly for water protection.

Condenser

- For the air-cooled ice maker, the condenser should be cleaned every three weeks. Clean using a soft brush or a vacuum cleaner with a brush attachment.
- The condenser filter should be cleaned every 2 weeks.

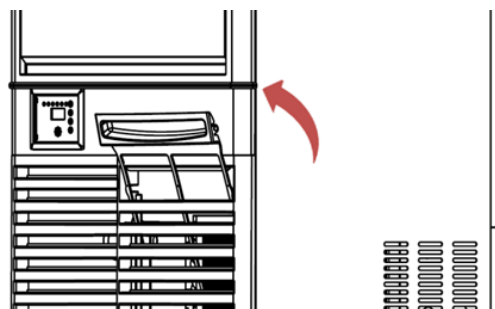

⚠ WARNING: Use caution while cleaning the condenser as the edges of the fins are sharp.

Water Pipe

In order to ensure food safety, the water pipe of the ice machine should be cleaned regularly.

Wintering

Turn off the water and power supply, drain the residual water from the water trough, inlet pipe and drain pipe.

Clean Function

⚠ NOTE: Empty the bin of ice in advance.

⚠ NOTE: Clean and sterilize the bin and rinse completely.

⚠ NOTE: Clean and sterilize the ice sliding board, water distribution pipe, water supply pipe, water pump, and rinse completely.

- Turn the ice maker on; press and hold the “CLEAN” button for 3 seconds, the ice maker will enter clean mode. Wait until the LED flashes “Clean”; then drain the water from the water trough.
- Add cleaning solution and follow the cleaning and sterilization instructions. Press the “CLEAN” button again, the ice maker will enter auto-clean mode for around 15 minutes. Once finished, the LED display will flash “Clean”; then drain the water from the water trough again.
- Add sterilizing solution manually and follow the cleaning and sterilizing process instructions. Press the “CLEAN” button again; the ice maker will enter an auto-sterilizing mode for about 15 minutes. When complete, the ice maker will enter a 5 cycle rinsing process.
- Once the cleaning process is complete, the ice maker will return to standard ice making mode.
- Discard the next 5 batches of ice.

Service Call

If the ice machine works abnormally, confirm below before making a service call:

1. Check the water supply:

- ✓ whether there is water in the water trough;
- ✓ whether the water pressure for the ice machine is 1.3 Bar to 5.5 Bar; the water temperature is 41-95°F (5-35 °C);
- ✓ whether the water valve is open;
- ✓ whether there is no water leakage;

2. Check the power:

- ✓ whether the panel display is not displaying the OFF standby state;
- ✓ If the LED on the display panel is blank or “OFF”, check whether the plug and socket are connected properly, and whether the power supply switch is ON.

3. Check nameplate and series number

- ✓ Check the nameplate located on the side or back of the ice machine and record the model and series number of the ice machine.

⚠ NOTE: If the machine fails due to the user’s faults, such as no water supply, electricity or environmental factors, rather than the fault of the ice maker, warranty will be voided.

Troubleshooting

Fault	Potential cause	Troubleshooting
Ice machine not working Indicator is "OFF"	Power switch not turned on Plug is loose	Turn on the power switch Check plug and socket
The display shows E04 high temperature The display shows E06 high pressure protection	The ambient temperature is too high Condenser or air filter is dirty and blocked High pressure switch wires fallen off Fan does not start	Normal working temperature range of 41-104°F (5-40°C) Clean the condenser and air filter Check and correct high pressure switch wires Check and correct the fan
Ice defrost abnormal	Ambient temperature too low Defrost valve does not start normally Ice thickness too thin or too thick	Normal working temperature range of 41-104°F (5-40°C) Check and correct the defrosting valve Check and correct ice thickness setting
Poor transparency of ice cubes; ice cubes too thin or incomplete	Ice thickness too thin Water pressure too low Water temperature too high Inlet water valve does not work Inlet water valve is dirty and blocked Water leaking Inlet water filter has not been replaced for a long time	Check and correct ice thickness setting Check that the water supply pressure is 1.3 Bar to 5.5 Bar Water temperature of 5-35 °C Check and correct the inlet water valve Check whether water leaks and correct Check and correct the inlet water filter Replace water filter
Machine is slow to make ice	The condenser or air filter is dirty High ambient temperature Poor ventilation Water temperature is too high	Clean the condenser and filter screen Normal working temperature range of 41-104°F (5-40°C) Check the environment around the ice machine Check the water supply temperature of 5-35 °C
Too much noise	The ice machine is not placed in a leveled foundation or the ice maker is not leveled.	Level the ice machine



For questions, contact NEXEL® Customer Service
at 1-800-245-6682 or visit www.nexelwire.com