

User Manual	Manual de Usuario	Manuel de l'Utilisateur
Customer Service US: 1-800-645-2986	Servicio de atención al Cliente US: 1-800-645-2986	Service à la clientèle Canada: 888-645-2986

Emergency Eyewash, Pedestal Mounted, Stainless Steel

Model 708382SS

The Global Industrial Eye Wash Station is essential for industrial spaces where accidents can occur with chemicals or hazardous substances. These units provide immediate, reliable and effective treatment as needed. High quality and durable components ensure these stations comply and meet ANSI Standard Z358.1.

PRODUCT INFO

Pipe & Fittings - Schedule 304 stainless steel includes safety yellow polyethylene covers for corrosion resistance and easy visibility.

Spray Head – Includes “flip top” covers to protect from dust particles.

Eye Wash Bowl – 304 stainless steel

Supply & Waste – Inlet and Outlet Tee allow inflow for water supply and separate outflow for waste disposal.

Quality Assurance – Valves and Spray heads are tested at factory to assure efficiency.

Please read this manual completely and save these instructions for reference. Upon receiving, inspect the unit for any damage. If damage is evident, notify the carrier immediately to file a claim. These products must be handled with caution.

Table of Contents	Page
General Information	2
Parts List	3
Product Dimensions	4
Assembly instructions	5
Warranty Info	8

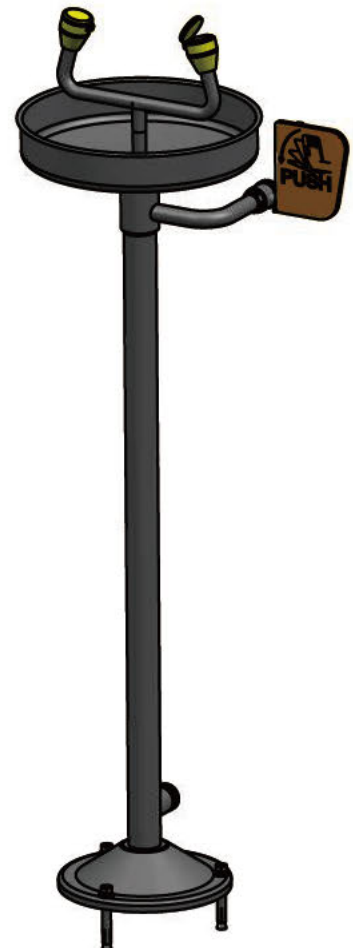

Emergency Eyewash, Pedestal Mounted, Stainless Steel

GENERAL INFORMATION & GUIDELINES

Emergency eye wash stations are designed to deliver water to rinse chemical substances from a person's eyes, face or body.

WARNING: Eye wash stations are NOT to be used as substitutes for primary protective equipment (such as gloves, masks, eye protection, and protective clothing) when handling dangerous substances. Simply installing these stations is not sufficient to assure worker safety. Staff must be trained in the use, maintenance, and knowledge of the eye wash station. A response plan and action should be in place in the event that an accident does occur and employees have guidelines to follow for injured personnel.

Below are guidelines that should be followed in accordance with the eye wash station when applicable. Note OSHA regulations, accessibility & surroundings, and water connections before assembling and installing the eye wash combo station. There are certain circumstances where these guidelines may not be adequate.

LOCATION OF EMERGENCY EQUIPMENT

- Per ANSI Specifications, emergency equipment must be installed on the same level as the possible incident (e.g. stairs/ramps must not be required to use the unit).
- It is advised that emergency equipment be installed within 10 seconds (approx. 55 feet) of walking time/distance from the location of the possible incident.

WATER TEMPERATURE

- Water temperature should be between 60°F(15.5°C) – 100°F(37.8°C). This can vary depending on the chemical substance and should be consulted with a safety counselor.

SHUT OFF VALVES

- These stationary eye wash units are designed to be connected to a clean and viable water supply line.
- A shut off valve on the water line is advised to easily maintain/repair the station.
- If a shut off valve is installed, make sure necessary procedures are established to prevent misuse of the valve. Only authorized personal should be installing/maintaining the shut off valve.

CORROSION & RUST RESISTANCE

- All parts of the system must be constructed of materials that will not corrode.

FREEZING CONDITIONS

- Emergency equipment that must be installed in potential freezing conditions should be installed with the proper equipment to protect against freezing per ANSI Z358.1 Section 4.5.5, 5.4.5.
- Freeze resistant equipment includes but is not limited to:
 1. Temperature actuated bleed valve that permits water to flow through the unit when the temperature drops below freezing.
 2. Remote-activated valves or electrically heated units/heated enclosures.



Emergency Eyewash, Pedestal Mounted, Stainless Steel

DISPOSAL OF WATER

- Waste water must be treated with care to avoid creating any hazards. It is highly recommended that emergency shower stations should be connected to drain piping or flood drains. Depending on the chemical substances, drainage into an acid waste disposal system may be recommended.

PARTS LIST		
Item	Description	QTY
A	Base with 1 1/4" Pipe	1
B	Valve Assembly	1
C	Eye Wash Container Bowl	1
D	Spray Head Assembly	1
E	Push Handle	1
H1	5/16-18 Hex Nut (Not shown)	3
H2	Lock Washer (Not shown)	3
H3	Plain Washer (Not shown)	3
H4	Sleeve (Not shown)	3
H5	Threaded Post (not shown)	3

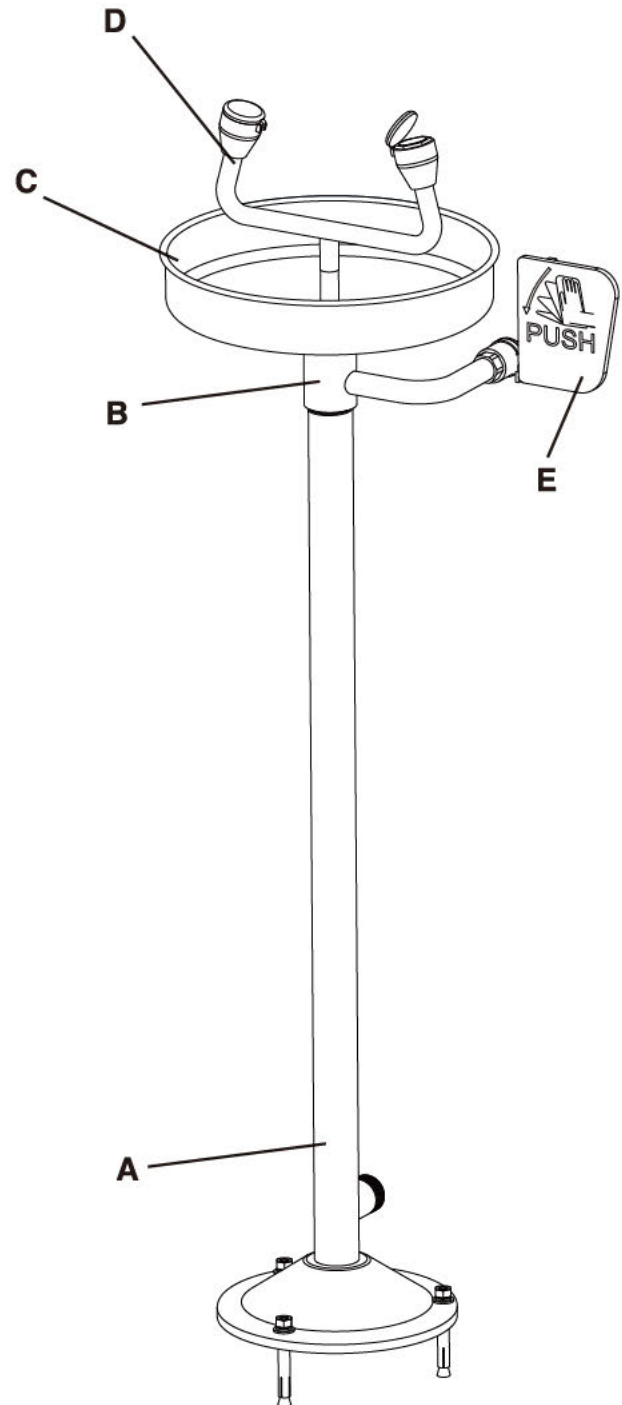

NOTE: The Eye Wash Gauge and Plumber's Tape is included



Emergency Eyewash, Pedestal Mounted, Stainless Steel

PRODUCT DIMENSIONS

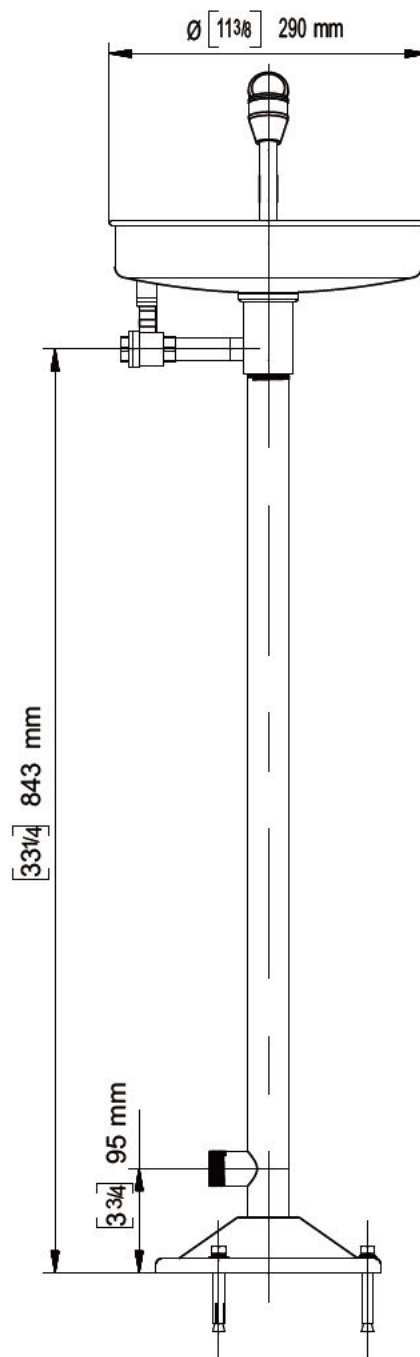
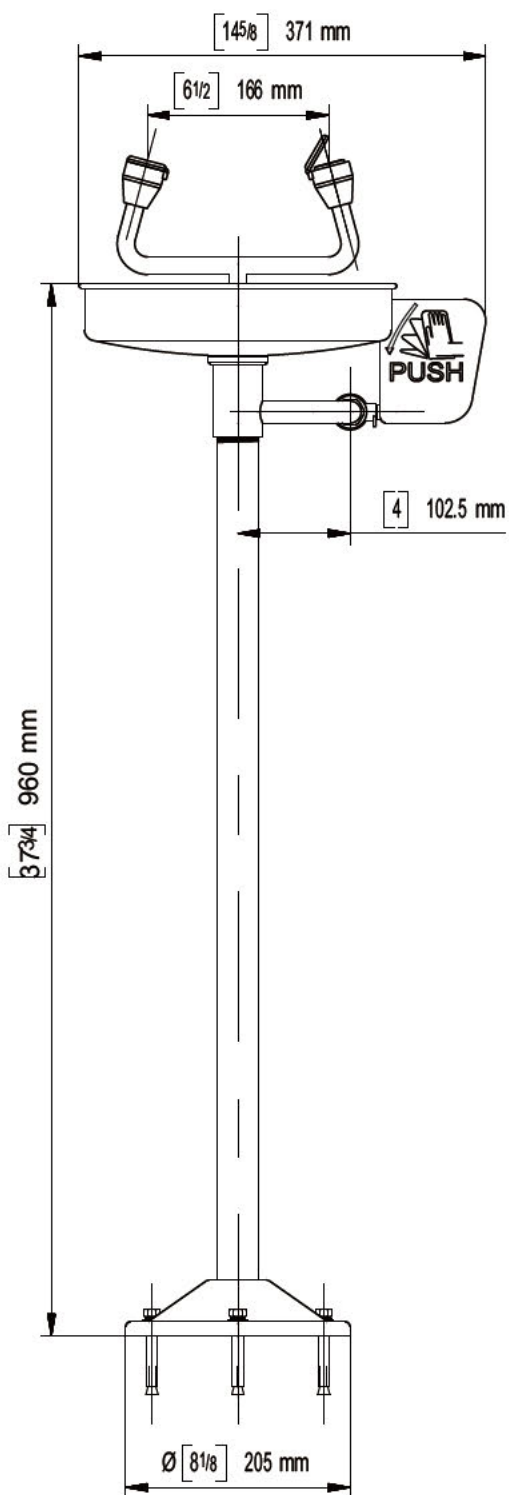

Emergency Eyewash, Pedestal Mounted, Stainless Steel

1

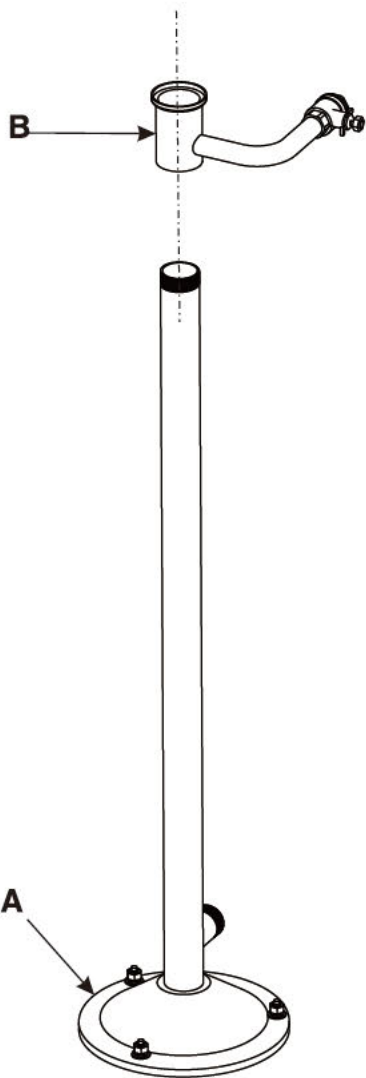

2

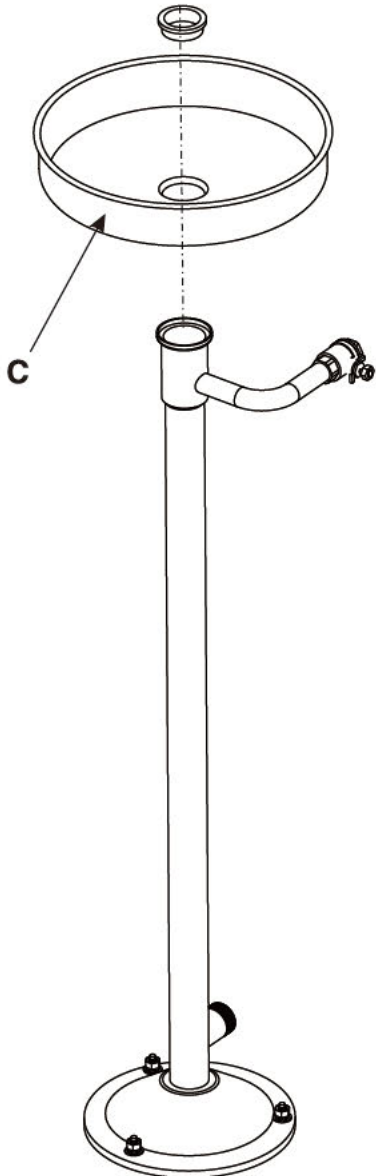

3

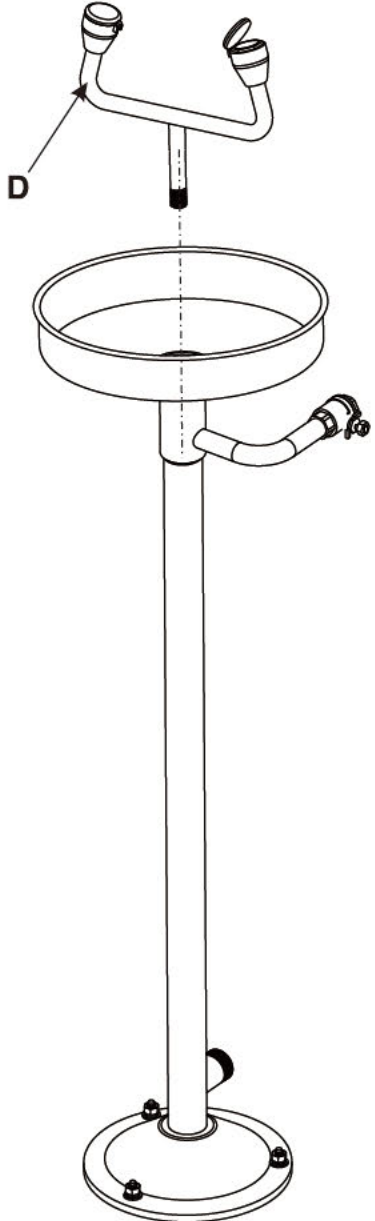

Emergency Eyewash, Pedestal Mounted, Stainless Steel

4

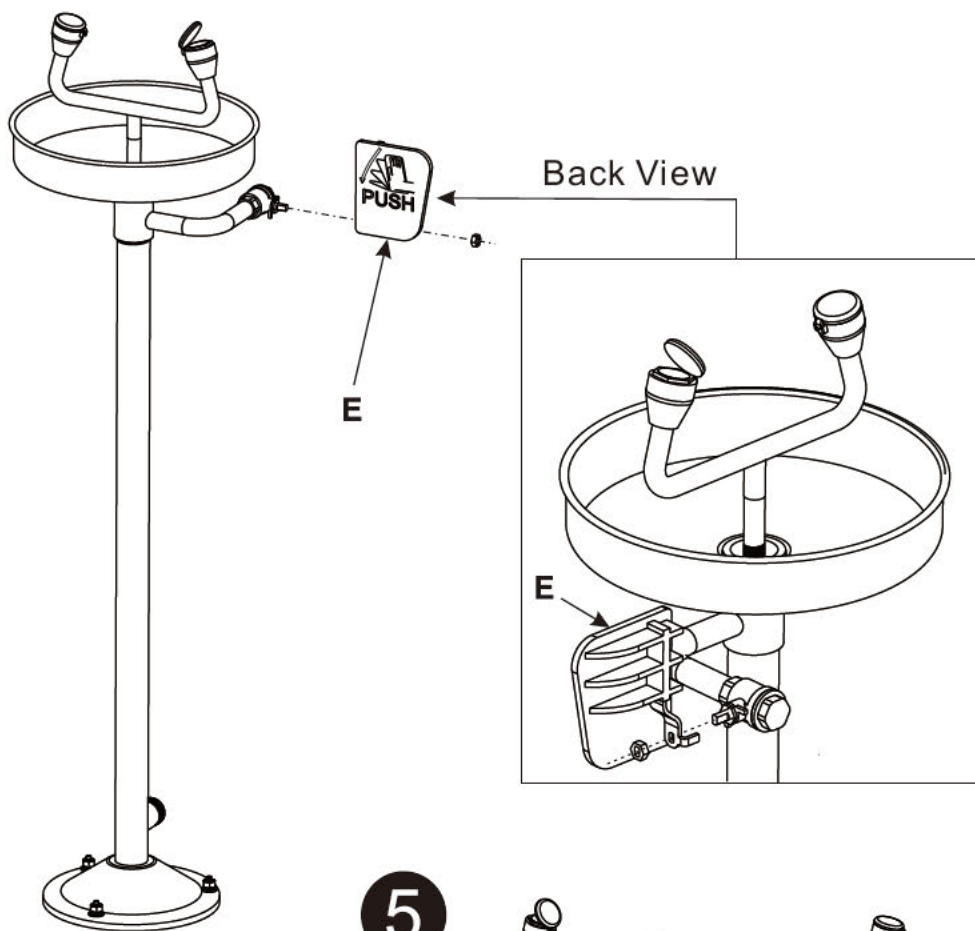

5

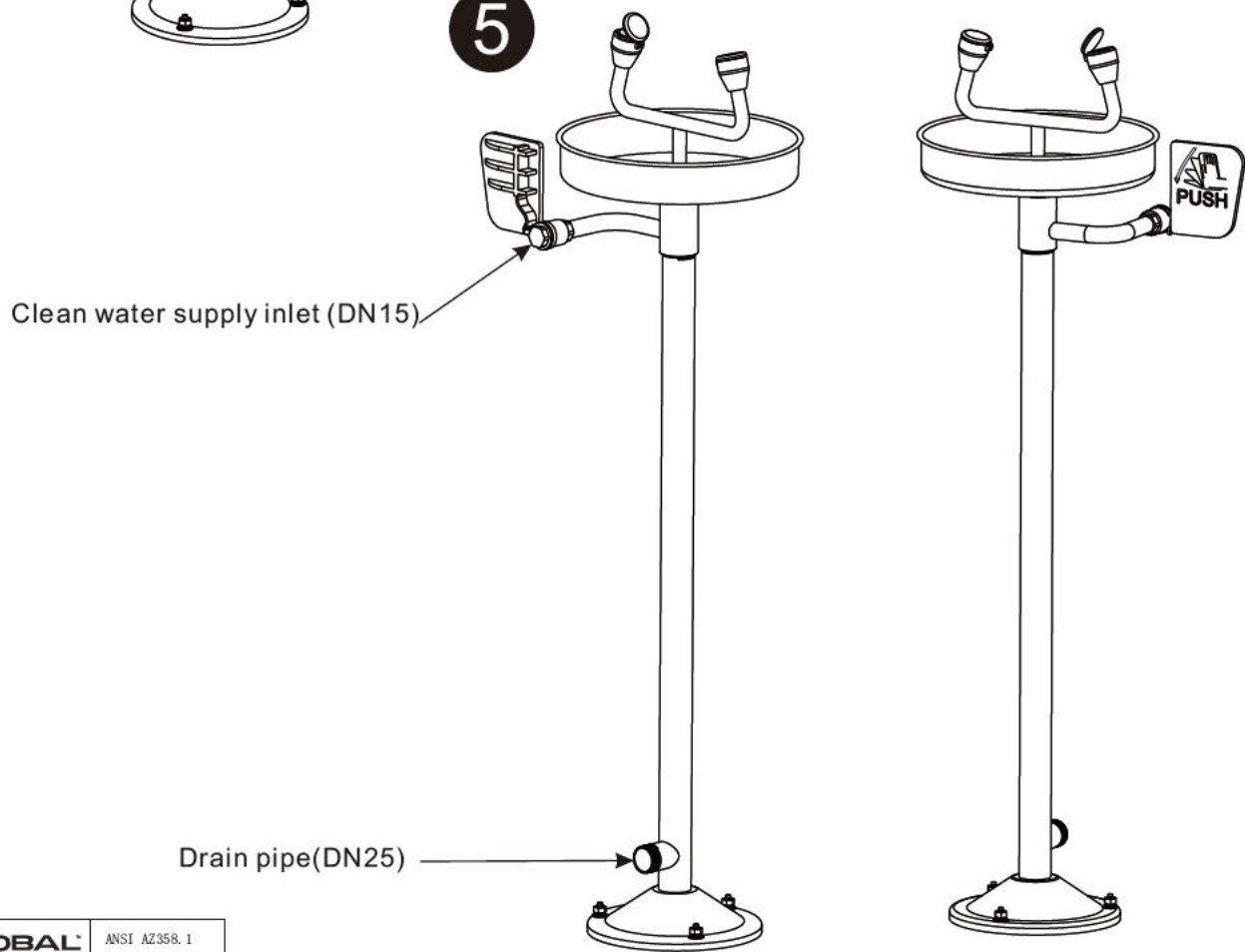

Clean water supply inlet (DN15)

Drain pipe(DN25)

GLOBAL INDUSTRIAL ANSI AZ358.1 COMPLIANT

Emergency Eyewash, Pedestal Mounted, Stainless Steel

ASSEMBLY INSTRUCTIONS

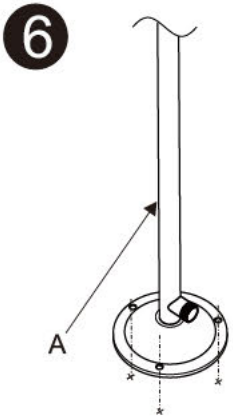

To be installed in concrete

Using the base as a template,
mark the (3) holes

▲ WARNING ▲

Before drilling
check for electrical wire,
rebar or other hidden
obstruction in floor.

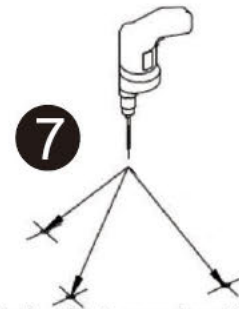

Drill the (3) holes 2" deep using 1/2" diameter
concrete drill bit (Provided)

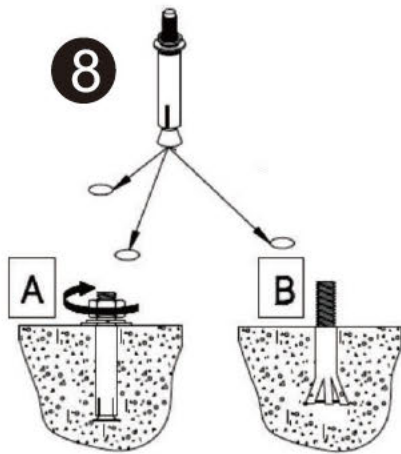

Insert the (3) expansion bolt into the holes
Hammer down until the sleeve
is level with concrete

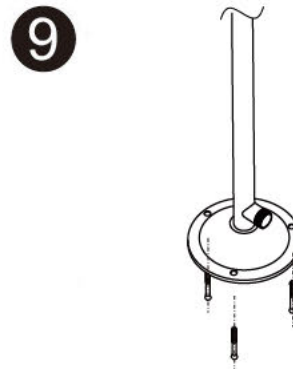

Affix the base to the studs

Note:

1. Before each connection,
Apply plumber's tape to threaded areas
(minimum two revolutions)
Typical for all male threads.
2. Tighten ALL connections for
proper alignment before
moving on to the next step.

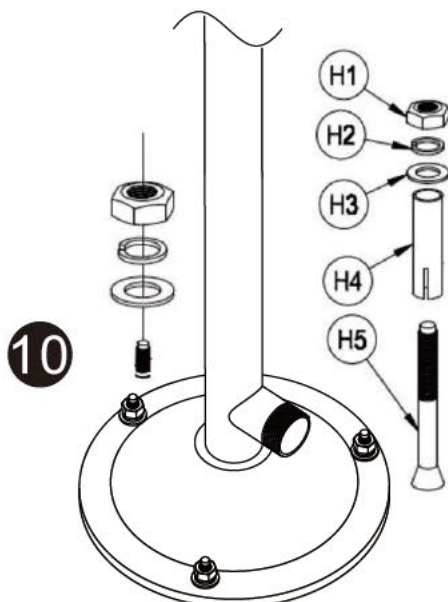

Emergency Eyewash, Pedestal Mounted, Stainless Steel



Over 1,000,000 products. Industrial strength service.
We can supply that.

REGISTER ONLINE AT

<http://www.globalindustrial.com/wr> or <http://www.globalindustrial.ca/wr>
Global Limited 1 Year Warranty

1. LIMITED WARRANTY

Global Equipment Company Inc. (DBA Global Industrial) ("Global") hereby warrants to you, the original purchaser and end user ("you" or "your"), that the products that you purchased which accompany this Limited Warranty ("Products") shall be free from defects in materials and workmanship under normal use consistent with the accompanying documentation for 1 year commencing upon the date of purchase (the "Warranty Period").

Global will repair or replace any Product determined to be defective and which has been returned, as set forth in section 3 herein, to Global. A Product may be replaced with a new or used product and/or current or prior revision. Where Global determines in its sole judgment that repair or replacement of such Product is not reasonable, Global will keep the non-conforming Product and refund to you the amount you paid for such Product. Returned Products shall be subject to the balance of the Warranty Period otherwise applicable. Any reconditioned parts used by Global shall be subject to all the same provisions as otherwise applicable to new parts.

THE FOREGOING DESCRIBES THE SOLE LIABILITY OF GLOBAL, AND YOUR SOLE REMEDY, FOR ANY BREACH OF WARRANTY. IF YOU DO NOT AGREE WITH THE TERMS OF THIS LIMITED WARRANTY, YOU MUST RETURN THE PRODUCTS UNUSED AND IN THEIR ORIGINAL PACKAGING WITHIN THREE (3) DAYS AND YOUR PURCHASE PRICE WILL BE REFUNDED.

2. WARRANTY EXCLUSIONS AND LIMITATION OF LIABILITY

This Limited Warranty does not cover: (i) defects or damages resulting from acts of God, casualty, accident, misuse or abuse, overloading, exceeding the recommended weight capacity, neglect, alterations, modification, service or repair by other than Global or its independent third party service providers, including without limitation by you; (ii) improper assembly or installation or de-installation, operation or maintenance, improper connections with peripherals or other causes not arising out of defects in the materials or workmanship of Products; (iii) any Product for which the warranty sticker has been removed, modified or defaced; (iv) shipping containers, batteries, cabinets, media, software or accessories; (v) normal wear and tear; (vi) damage to or loss of repaired or replaced Products during shipping by Global except when such damage or loss is caused by poor or inadequate packaging by Global; or (vii) Products purchased outside the United States or Canada.

UNDER NO CIRCUMSTANCES WILL GLOBAL BE LIABLE FOR ANY LOSS OF USE, INTERRUPTION OF BUSINESS OR ANY INDIRECT, SPECIAL, INCIDENTAL, PUNITIVE OR CONSEQUENTIAL DAMAGES OF ANY KIND (INCLUDING LOST PROFITS) REGARDLESS OF THE FORM OF ACTION WHETHER IN CONTRACT, TORT (INCLUDING NEGLIGENCE), STRICT PRODUCT LIABILITY OR OTHERWISE, EVEN IF GLOBAL HAS BEEN ADVISED OF THE POSSIBILITY OF SUCH DAMAGES. IN NO EVENT SHALL THE TOTAL LIABILITY OF GLOBAL HEREUNDER EXCEED THE GREATER OF \$50 OR THE AMOUNT YOU ACTUALLY PAID FOR THE PRODUCT GIVING RISE TO SUCH LIABILITY, REGARDLESS OF THE CAUSE OF ACTION, IN CONTRACT, TORT, STRICT LIABILITY OR OTHERWISE. NOT ALL JURISDICTIONS ALLOW SUCH LIMITATIONS OF DAMAGES SO THE FOREGOING LIMITATIONS MAY NOT APPLY TO YOU.

3. PROCEDURE FOR WARRANTY SERVICE

Prior to returning any Products to Global for warranty service, you must first contact Global, by telephone at (800) 645-2986 (US) or (888) 645-0878 (Canada) to confirm that such Products are covered by this Limited Warranty. If such Products are so covered, you shall obtain from Global a return materials authorization ("RMA") number and shipping instructions prior to any shipment of such Products to Global, and you must include such RMA number with any corresponding Product shipment, along with a true and correct copy of the original receipt showing the date of Product purchase by you, and a detailed, written description of any associated Product problems.

Please note that you are responsible for all shipping charges incurred in returning an item for exchange or repair. Global shall pay for return shipping of repaired and/or replaced Products to addresses within the United States and Canada only, and return shipments to all other addresses outside of the United States or Canada is your responsibility. If Global determines that any Product is not covered by this Limited Warranty, you must pay all parts, labor charges and return shipping for such Product.

4. WARRANTY DISCLAIMER AND LIMITATIONS

EXCEPT AND TO THE EXTENT EXPRESSLY SET FORTH ABOVE THERE ARE NO WARRANTIES, EXPRESS OR IMPLIED, INCLUDING BUT NOT LIMITED TO, ANY WARRANTIES OF MERCHANTABILITY OR FITNESS FOR A PARTICULAR PURPOSE AND GLOBAL EXPRESSLY DISCLAIMS ALL WARRANTIES NOT STATED HEREIN.

EXCEPT AND TO THE EXTENT EXPRESSLY SET FORTH ABOVE, THE PRODUCTS ARE PROVIDED ON AN "AS IS" BASIS, AND GLOBAL MAKES NO ADDITIONAL WARRANTIES, EXPRESS, IMPLIED, ARISING FROM COURSE OF DEALING OR USAGE OF TRADE, OR STATUTORY, AS TO THE PRODUCTS OR ANY MATTER WHATSOEVER. THIS IS A LIMITED WARRANTY AND IS THE ONLY WARRANTY MADE BY GLOBAL. THE AGENTS, EMPLOYEES, DISTRIBUTORS, AND DEALERS OF GLOBAL ARE NOT AUTHORIZED TO MAKE MODIFICATIONS TO THIS LIMITED WARRANTY, OR MAKE ADDITIONAL WARRANTIES BINDING ON GLOBAL. ACCORDINGLY, ADDITIONAL STATEMENTS SUCH AS DEALER ADVERTISING OR PRESENTATION, WHETHER ORAL OR WRITTEN, DO NOT CONSTITUTE WARRANTIES BY GLOBAL AND SHOULD NOT BE RELIED UPON. GLOBAL DOES NOT WARRANT THAT THE PRODUCTS WILL OPERATE WITHOUT FAILURE, OR THAT THE PRODUCTS WILL MEET YOUR NEEDS OR EXPECTATIONS. NOT ALL JURISDICTIONS ALLOW SUCH WARRANTY LIMITATIONS SO THE FOREGOING LIMITATIONS MAY NOT APPLY TO YOU.

5. CHOICE OF LAW AND JURISDICTION

FOR PURCHASES WITHIN THE US - This Limited Warranty shall be subject solely to the laws of the State of New York as applied to contracts entered into in the State of New York between New York residents. Any dispute arising hereunder shall be subject to the sole jurisdiction of the State and Federal Courts located in Nassau County, New York. The parties hereby consent to the personal jurisdiction of such courts.

FOR PURCHASES WITHIN CANADA - This Limited Warranty shall be subject solely to the laws of the Province of Ontario. Any dispute arising hereunder shall be subject to the sole jurisdiction of Ontario, Canada. The parties hereby consent to the personal jurisdiction of such courts.



Emergency Eyewash, Pedestal Mounted, Stainless Steel

REGISTRARSE EN L NEA EN

<http://www.globalindustrial.com/wr> or <http://www.globalindustrial.ca/wr>

Garant a global limitada de 1 a o

1. GARANT A LIMITADA

Global Equipment Company Inc. (DBA Global Industrial) ("Global") por la presente garantiza al comprador original y usuario final ("usted" o "su"), que los productos adquiridos por usted que incluyen esta Garant a limitada ("Productos") se considerarán libres de defectos respecto de sus materiales y mano de obra en condiciones normales de uso de conformidad con la documentación adjunta durante 1 a o a partir de la fecha de compra (el "Plazo de duraci n de la garant a").

Global reparar o reemplazar todo producto calificado como defectuoso y que hubiere sido devuelto a Global, seg n lo establecido en la secci n 3 de la presente garant a. Un Producto puede ser reemplazado por un producto nuevo o usado y/o quedar sujeto a una revisi n actual o previa. En los casos que Global establezca, a su exclusivo criterio, la inviabilidad de la reparaci n o el reemplazo de dicho Producto, Global conservará el Producto no conforme y le reembolsará a usted el monto abonado por dicho Producto. De ser aplicable, los Productos devueltos estar n sujetos al tiempo restante del "Plazo de Duraci n de la Garant a. Todas las piezas reacondicionadas utilizadas por Global estar n tambi n sujetas a dichas disposiciones mencionadas anteriormente, aplicables de igual modo a las piezas nuevas, si correspondiere

LA CL USULA MENCIONADA ANTERIORMENTE DESCRIBE LA RESPONSABILIDAD EXCLUSIVA DE GLOBAL, Y SU NICO RECURSO, POR CUALQUIER INCUMPLIMIENTO DE LA PRESENTE GARANT A. SI USTED NO EST DE ACUERDO CON LOS T RMINOS Y CONDICIONES DE LA PRESENTE GARANT A LIMITADA, USTED DEBER DEVOLVER LOS PRODUCTOS SIN HABERLOS UTILIZADO Y EN SU EMBALAJE ORIGINAL EN EL PLAZO DE TRES (3) D AS Y USTED RECIBIR EL REEMBOLSO DEL DINERO DE SU COMPRA.

2. EXCLUSIONES DE LA PRESENTE GARANT A Y LIMITACI N DE RESPONSABILIDAD

La presente Garant a limitada no cubre los siguientes supuestos: (i) defectos o da os causados por fuerza mayor, accidentes, uso inapropiado o excesivo, sobrecarga que supere la capacidad del peso recomendado, negligencia, alteraciones, modificaci n, reparaci n o mantenimiento realizados por proveedores t rminos independientes o ajenos a Global, entre los que se incluyen las siguientes acciones realizadas por usted; (ii) ensamble o instalaci n o desinstalaci n inadecuados, operaci n o mantenimiento, conexiones perif ricas, funcionamiento o mantenimiento incorrectos, o cualquier otra causa que no surja de un defecto en los materiales o en la mano de obra del Producto; (iii) todo Producto que no contenga el sticker de garant a o cuando dicho sticker haya sido retirado, modificado o est da ado; (iv) contenedores de env o, bater as, gabinetes, medios, software o accesorios; (v) desgaste normal por el paso del tiempo; (vi) da o o p rrida de los Productos reparados o reemplazados durante el env o por parte de Global en los casos en que dicho da o o p rrida se hubieren producido por un mal o inadecuado embalaje por parte de Global; o (vii) Productos adquiridos fuera de los Estados Unidos o Canad .

EN NING N CASO GLOBAL SER RESPONSABLE POR LA PR IDIDA DE USO, INTERRUPTI N DE NEGOCIOS O CUALQUIER TIPO DE DA O INDIRECTO, ESPECIAL, INCIDENTAL, PUNITIVO O CONSECUENTE (INCLUIDA LA PR IDIDA DE GANANCIAS), INDEPENDIENTEMENTE DEL TIPO DE ACCI N LEGAL, YA SEA EMANADOS DE UN CONTRATO, DE UN ACTO IL CITO (INCLUIDA LA CULPA), RESPONSABILIDAD OBJETIVA SOBRE EL PRODUCTO U OTROS. LO ANTERIOR SE APLICAR A N EN LOS CASOS EN QUE GLOBAL HAYA SIDO ADVERTIDA SOBRE LA POSIBILIDAD DE DICHA OS. EN NING N CASO, EN VIRTUD DE LA PRESENTE GARANT A, EL MONTO INDEMNIZATORIO POR RESPONSABILIDAD DE GLOBAL PODR EXCEDER LOS USD 50.00 O LA SUMA QUE USTED HAYA PAGADO POR EL PRODUCTO OBJETO DE DICHA RESPONSABILIDAD, INDEPENDIENTEMENTE DE LA CAUSAL DE LA ACCI N LEGAL, POR EL CONTRATO, ACTO IL CITO, RESPONSABILIDAD OBJETIVA U OTRAS. DADO QUE NO EN TODAS LAS JURISDICCIONES RIGEN DICHAS LIMITACIONES EN LAS INDEMNIZACIONES, LAS LIMITACIONES ANTERIORES PUEDEN NO SER APLICABLES EN SU CASO.

3. PROCEDIMIENTO PARA EL SERVICIO DE GARANT A

Antes de devolver un Producto a Global para obtener el servicio de garant a, Usted debe contactar a Global, por tel fono al (800) 645-2986 (Estados Unidos) 888 645-0878 (Canad) a los fines de confirmar que dicho Producto est contemplado en la presente Garant a Limitada. Si dicho Producto estuviera cubierto por la Garant a, usted recibir un nmero de autorizaci n de devoluci n de materiales de Global (en adelante, "ADM") y las instrucciones de env o previas al env o del Producto mencionado a Global. Usted deber incluir su nmero de ADM con el env o del Producto correspondiente, junto con una copia fiel del recibo original que incluya la fecha de la compra del Producto realizada por usted.

Por favor tenga en cuenta que usted ser responsable de todos los gastos de env o resultantes de la devoluci n de un articulo para su reemplazo o reparaci n. Global deber abonar el env o de devoluci n del Producto reparado o reemplazado a direcciones dentro de Estados Unidos y Canad solamente. Los gastos de env o a todas las dem s direcciones fuera de Estados Unidos y Canad quedan bajo su responsabilidad. En el caso de que Global estableciera que un Producto no se encuentra contemplado en la presente Garant a Limitada, usted deber pagar todos los repuestos, la mano de obra y los gastos de env o por la devoluci n de dicho Producto

4. EXCLUSIONES Y LIMITACIONES DE LA GARANT A

SALVO EN LA MEDIDA EXPRESAMENTE ESTABLECIDA ANTERIORMENTE, NO EXISTEN DENTRO DE LA PRESENTE GARANT AS EXPRESAS O IMPL CITAS, INCLUIDAS, AUNQUE SIN LIMITACI N, GARANT AS IMPL CITAS DE COMERCIABILIDAD O IDONEIDAD PARA UN PROP SITO DETERMINADO Y GLOBAL RECHAZA CUALQUIER TIPO DE GARANT A NO INCLUIDA EN LA PRESENTE.

SALVO EN LA MEDIDA EXPRESAMENTE ESTABLECIDA ANTERIORMENTE, LOS PRODUCTOS SON ENTREGADOS EN EL "ESTADO EN QUE SE ENCUENTRAN". GLOBAL NO OFRECE GARANT A ALGUNA, NI EXPRESA NI IMPL CITA, QUE PUDIERA SURGIR DURANTE EL TRANSCURSO DE UNA NEGOCIACI N O EL USO O QUE SEAN ESTABLECIDAS POR LEY, EN LO QUE RESPECTA A LOS PRODUCTOS O A CUALQUIER OTRO ASUNTO. LA PRESENTE CONSTITUYE UNA GARANT A LIMITADA Y ES LA NICA GARANT A OTORGADA POR GLOBAL. LOS MANDATARIOS, EMPLEADOS, DISTRIBUIDORES Y COMERCIANTES DE GLOBAL NO PODR N REALIZAR MODIFICACIONES A LA PRESENTE GARANT A LIMITADA NI PRESTAR GARANT AS ADICIONALES QUE OBLIGUEN LEGALMENTE A GLOBAL. EN CONSECUENCIA, TODA DECLARACI N ADICIONAL, TALES COMO PUBLICIDADES O PRESENTACIONES DEL COMERCIANTE, YA SEAN ORALES O ESCRITAS, NO CONSTITUIR N GARANT AS OTORGADAS POR GLOBAL Y NO DEBER N CONSIDERARSE V LIDAS. GLOBAL NO GARANTIZA QUE LOS PRODUCTOS FUNCIONEN SIN FALLAS O QUE SATISFAGAN SUS NECESIDADES O EXPECTATIVAS. DADO QUE NO EN TODAS LAS JURISDICCIONES RIGEN DICHAS LIMITACIONES EN LAS INDEMNIZACIONES, LAS LIMITACIONES DE LA CL USULA PUEDEN NO SER DE APLICACI N EN SU CASO.

5. ELECCI N DE LA LEGISLACI N Y JURISDICCI N

PARA COMPRAS REALIZADAS DENTRO DE LOS ESTADOS UNIDOS, la presente Garant a Limitada estar sujeta nicamente a las leyes del Estado de Nueva York, seg n se aplica a los contratos celebrados en el Estado de Nueva York entre residentes del Estado de Nueva York. Toda controversia que surja en virtud de la presente Garant a quedar sujeta a la sola jurisdicci n de los Tribunales Estatales y Federales ubicados en el Condado de Nassau, Nueva York. Por medio de la presente Garant a, las partes acuerdan someterse a la jurisdicci n personal de dichos tribunales.

PARA COMPRAS REALIZADAS EN CANAD - La presente Garant a Limitada quedar sujeta nicamente a las leyes de la Provincia de Ontario. Toda controversia que surja en virtud de la presente Garant a quedar sujeta a la sola jurisdicci n de Ontario, Canad . Por medio de la presente Garant a, las partes acuerdan someterse a la jurisdicci n personal de dichos tribunales.

INSCRIVEZ-VOUS EN LIGNE AU

<http://www.globalindustrial.com/wr> or <http://www.globalindustrial.ca/wr>

Garantie globale limit e de 1 an

1. GARANTIE LIMIT E

Global Equipment Company Inc. (DBA Global Industrial) («Global») vous garantit, l'acheteur initial et l'utilisateur («vous» ou «votre»), que les produits que vous avez achetés et qui accompagnent cette garantie limit e («produits») sont exempts de tout d faut de mat riaux et fabrication dans des conditions normales d'utilisation conformément la documentation suivant pour une p riode d'un an d butant la date d'achat (la «p riode de garantie»).

Global r parera ou remplacera tout produit jug d factueux et qui a t retourn , tel que stipul la section 3 ci-dessous. Global. Un produit peut tre remplacé par un produit neuf ou usagé et/ou par une r vision actuelle ou ant rieure. Lorsque global d termine son seul jugement que la r paration ou le remplacement de ce produit n'est pas raisonnable, Global gardera le produit non conforme et vous remboursera le montant que vous avez payé pour ce produit. Les produits retourn s sont soumis au reste de la p riode de garantie applicable par ailleurs. Toutes les pi ces reconditionn es utilis es par Global sont soumises toutes les m mes dispositions que celles qui s'appliquent autrement aux nouvelles pi ces.

CE QUI PR C DE D CRIT LA RESPONSABILIT EXCLUSIVE DE GLOBAL, ET VOTRE SEUL RECOURS, POUR TOUT MANQUEMENT LA GARANTIE. SI VOUS N' TES PAS D'ACCORD AVEC LES TERMES DE CETTE GARANTIE LIMIT E, VOUS DEVEZ RETOURNER LES PRODUITS INUTILIS S ET DANS LEUR EMBALLAGE D'ORIGINE DANS LES TROIS (3) JOURS ET VOTRE PRIX D'ACHAT SERA REMBOURS .

2. EXCLUSIONES DE GARANTIE ET LIMITATION DE RESPONSABILIT

La pr sente garantie limit e ne couvre pas: (i) les d fauts ou dommages r sultant d'actes de Dieu, d'accident, de mauvais usage ou d'abus, de surcharge, du d passage de la capacit de poids recommand e, de n gligence, des alt rations, modification, service ou r paration par autre que Global ou ses fournisseurs de services tiers ind pendants, y compris sans vos limites; (ii) d'un montage ou d'une installation ou d'une d nstallation, d'un fonctionnement ou d'un entretien incorrects, des connexions incorrectes avec des p riph riques ou d'autres causes ne r sultant pas de d fauts dans les mat riaux ou la fabrication de produits; (iii) tout produit pour lequel la vignette de garantie a t enlev e, modifi e ou d figur e; (iv) des conteneurs, piles, armoires, supports, logiciels ou accessoires d'exp dition; (v) d'une usure normale; (vi) des dommages ou la perte de produits r par s ou remplac s pendant l'exp dition par Global, sauf si ces dommages ou pertes sont caus s par des emballages pauvres ou inad quats par Global; ou (vii) des produits achetés en dehors des tats-Unis ou du Canada.

GLOBAL NE POURRA EN AUCUN CAS TRE TENU RESPONSABLE DE TOUTE PERTE D'UTILISATION, D'INTERRUPTION D'ACTIVIT OU DE TOUT DOMMAGE INDIRECT, SP CIAL, ACCIDENTEL, PUNITIF OU CONS CUTIF DE QUELQUE NATURE QUE CE SOIT (Y COMPRIS LES PERTES DE PROFITS), QUELLE QUE SOIT LA FORME D'ACTION CONTRACTUELLE, D LICTUELLE (Y COMPRIS LA N GLIGENCE), LA RESPONSABILIT STRICTE DU PRODUIT OU AUTRE, M ME SI GLOBAL A T AVIS DE LA POSSIBILIT DE TELS DOMMAGES. EN AUCUN CAS LA RESPONSABILIT ENTI RE CI-DESSOUS DE GLOBAL NE D PASSERA CE QUI EST PLUS LEV ENTRE \$50 OU LE MONTANT QUE VOUS AVEZ EFFECTIVEMENT PAYÉ POUR LE PRODUIT DONNANT LIEU CETTE RESPONSABILIT , IND PENDamment DE LA CAUSE D'ACTION, DANS LE CONTRAT, LE D LIT, LA RESPONSABILIT STRICTE OU AUTREMENT. TOUTES LES JURISDICTIONS N'AUTORISENT PAS CES LIMITATIONS DE DOMMAGES, DE SORTE QUE LES LIMITATIONS QUI PR C DENT PEUVENT NE PAS S'APPLIQUER VOUS.

3. PROC DURE DE SERVICE SOUS GARANTIE

Avant de retourner tous les produits Global pour le service de garantie, vous devez d'abord contacter Global, par t l phone au (800) 645-2986 (US) ou (888) 645-0878 (Canada) pour confirmer que ces produits sont couverts par cette garantie limit e. Si ces produits sont ainsi couverts, vous obtiendrez de Global un num ro d'autorisation de retour de mat riel («ARM») et des instructions d'exp dition avant toute exp dition de ces produits global et vous devez inclure ce num ro ARM avec n'importe quelle exp dition correspondante de produit, ainsi qu'une copie exacte et correcte du reçu original indiquant la date d'achat de l'achat de votre produit, ainsi qu'une description d taill e et cr ite de tout probl me de produit associ .

Veillez noter que vous tes responsable de tous les frais d'exp dition engag s pour retourner un article pour un change ou une r paration. Global doit payer pour l'exp dition de retour des produits r par s et/ou remplac s aux adresses aux tats-Unis et au Canada seulement ainsi que pour les exp ditions de retour toutes les autres adresses l'ext rieur des tats-Unis ou du Canada en revient de votre responsabilit . Si Global d termine que n'importe quel produit n'est pas couvert par cette garantie limit e, vous devez payer toutes les pi ces, frais de main-d'œuvre et exp dition de retour pour ce produit.

4. D NI DE GARANTIE ET LIMITATIONS

SAUF ET DANS LA MESURE EXPRESS MENT NONC E CI-DESSUS IL N'Y A AUCUNE GARANTIE, EXPRESSE OU IMPL ICITE, Y COMPRIS MAIS SANS S'Y LIMITER TOUTE GARANTIE DE QUALIT MARCHANDE OU D'ADAPTATION UN USAGE PARTICULIER ET GLOBAL D CLINE EXPRESS MENT TOUTES LES GARANTIES NON MENTIONN ES DANS LE PR SENT DOCUMENT.

SAUF ET DANS LA MESURE EXPRESS MENT NONC E CI-DESSUS, LES PRODUITS SONT FOURNIS SONT FOURNIS SUR UNE BASE «TEL QUEL» ET GLOBAL NE FAIT AUCUNE GARANTIE ADDITIONNELLE, EXPRESSE, IMPL ICITE, D COULANT DE COURS DE TRAITEMENT OU D'UTILISATION DU COMMERCE OU STATUTAIRE, QUANT AUX PRODUITS OU QUELQUE MATI RE QUE CE SOIT. IL S'AGIT D'UNE GARANTIE LIMIT E ET EST LA SEULE GARANTIE FAITE PAR GLOBAL. LES AGENTS, LES EMPLOY S, LES DISTRIBUTEURS ET LES CONCESSIONNAIRES DE GLOBAL NE SONT PAS AUTORIS S APPORTER DES MODIFICATIONS CETTE GARANTIE LIMIT E, OU FAIRE DES GARANTIES SUPPL MENTAIRES CONTRAIGNANTES POUR GLOBAL. PAR CONS QUENT, DES D CLARATIONS SUPPL MENTAIRES TELLES QUE LA PUBLICIT OU LA PR SENTATION DES CONCESSIONNAIRES, QUELLES SOIENT ORALES OU CRITES, NE CONSTITUENT PAS DES GARANTIES GLOBALES ET NE DEVAIENT PAS TRE INVOQU ES. GLOBAL NE GARANTIT PAS QUE LES PRODUITS FONCTIONNERONT SANS D FAILLANCE OU QUE LES PRODUITS R PONDONT VOS BESOINS OU VOS ATTENTES. PAS TOUTES LES JURISDICTIONS NE PERMETTENT DE TELLES LIMITATIONS DE GARANTIE AINSI LES LIMITATIONS CI-DESSUS PEUVENT NE PAS S'APPLIQUER VOUS.

5. CHOIX DE LA LOI ET DE LA JURISDICTION

POUR LES ACHATS AUX TATS-UNIS : cette garantie limit e est soumise aux seules lois de l' tat de New York, telles qu'appliqu es aux contrats conclus dans l' tat de New York entre les r sidents de New York. Tout litige d coulant des pr sentes est soumis la seule comp tence de l' tat et des tribunaux f d raux situ s dans le com t de Nassau, New York. Les parties consentent par la pr sente la comp tence personnelle de ces tribunaux.

POUR LES ACHATS AU CANADA : cette garantie limit e est assujettie uniquement aux lois de la province de l'Ontario. Tout diff rend d coulant des pr sentes est assujetti la seule comp tence de la province de l'Ontario, au Canada. Les parties consentent par la pr sente la comp tence personnelle de ces tribunaux.



ANSI AZ358.1
COMPLIANT