

**Owner's Manual**
**Model 604151**

*Please read and save these instructions. Read carefully before attempting to assemble, install, operate or maintain the product described.*

*Protect yourself and others by observing all safety information. Failure to comply with instructions could result in personal injury and / or property damage! Retain instructions for future reference.*

## Description

The Global Industrial Portable Air Conditioner features spot cooling for large areas where cooling of the entire area is not practical. A dedicated spot cooling thermostat controls the unit in this application. These air conditioners can also be used in smaller areas for room cooling.

A control panel provides ease of use and contains a self-diagnostic function and display, showing operating modes, room and set temperatures, and faults.

If an abnormal operation occurs, a visual display of the fault is shown. Caster wheels are included for easy portability. Suitable applications include: a factory or work place, industrial kitchen, computer room, emergency cooling, outdoor event, etc.



**604151**  
**Figure 1**

## Unpacking

After unpacking the unit, carefully inspect unit for any damage that may have occurred during transit. Check for any loose, missing, or damaged parts.

## Specifications

Model No.	Power Supply Ph-V-Hz	Cooling Capacity Btu/h	Power Consumption W	Rated Current Amps	EER Btu/Wh
604151	Single Phase, 115V, 60Hz	12,200	1700	15	7.17
Model No.	Nema Plug	Power Cord Gauge AWG	Power Cord Length ft	Dimensions W x H x D - in.	
604151	5-20P	12	10	20.4 x 40.9x 26.3	
Model No.	Weight (Net / Gross) Lbs	Condensate tank Gallons(Liters)	No. of Cool Air Outlets Pcs	Ambient temperature range °F( °C)	
604151	202/253	3.96 (15)	2	41~113 (5~45)	

## Specifications (Continued)

Model No.	Setting temperature (Room cool mode) °F( °C)	Setting temperature (Spot cool mode) °F( °C)
604151	64~86 (18~30)	32~86 (0~30)

Model No.	Application Area (Room cool mode) ft <sup>2</sup> (m <sup>2</sup> )	Refrigerant Type / oz(g)	Design Pressure - Hi/Low Psig
604151	315 (30)	R-410A / 24.7 (700)	450 / 250

Model No.	Indoor Air Flow (High/Low)CFM(CMM)	Wheels pcs / diameter	Exhaust Duct Diameter	Maximum Duct Length ft
604151	10m 558 (15.8)	4 / 3"	12"	50'
	20m 491 (13.9)			
	30m 406 (11.5)			

Safety Devices	Compressor overload protector, Anti-freezing thermostat, Full drain tank switch, Automatic restart (Power interruption), Compressor time delay program, High pressure switch
----------------	--

Features	Temperature control, Self-diagnostic function, Two speed fan, Optional drain pump kit, Washable filters, °F( °C) display, Off-timer
----------	---

## General Safety Information

Please read this manual carefully for instructions on correct installation and usage. Please read all safeguards.

1. Transport and store the unit in an upright position only. Leave unit in an upright position for at least 3 hours before first use.
2. Always place the unit on an even, level surface.
3. Ensure the unit is connected to a grounded power supply of the correct rating / capacity.
4. The unit will cool when the room temperature is between 41°F ~ 113°F depending on the thermostat setting.
5. DO NOT use this unit for functions other than those described in this instruction manual.
6. DO NOT tilt the unit.
7. DO NOT cover or obstruct the unit's inlet and outlet grilles.
8. DO NOT use the unit in areas where it will be exposed to rain or water.
9. NEVER unplug the unit while it is operating.

**▲ WARNING** *DO NOT use the unit in wet environments, such as a laundry room, to avoid the risk of electrical shock.*

10. DO NOT place any foreign objects on the unit.
11. DO NOT operate the unit with wet or damp hands.
12. DO NOT allow chemical substances to come into contact with the unit.
13. DO NOT operate the unit in the presence of flammable substances or vapors such as alcohols, pesticides, gasoline, etc.

**▲ WARNING** *DO NOT operate the unit in explosive or flammable environments.*

14. DO NOT use the plug to start and to stop the unit. Always use the control panel to start and to stop the unit.
15. Always turn off the unit when it is not in use and unplug the power plug from the electrical outlet.
16. Always turn the unit off and unplug the main power plug from the electrical outlet before cleaning, moving or performing maintenance.
17. AVOID the use of adapter plugs or extension cords. If it is necessary to use an extension cord or an adapter plug to operate the unit, ensure that they are correctly rated for the application. Consult a local qualified electrician and all local electrical codes to ensure proper setup. Any extension cord used with this device must be rated for a minimum of 20A (220V).
18. DO NOT unplug the unit by pulling on the electrical cord. Keep electrical cord away from heat sources and always completely unroll the cord to avoid overheating. If the power cord becomes damaged, a qualified service agent, qualified electrician, or similarly qualified person must replace it, in order to avoid a hazard or shock.

**▲ WARNING** *DO NOT operate a unit with a damaged power cord.*

19. The filters must be used with the product at all times. When the filters are removed for cleaning, always ensure that the unit has been turned off and unplugged from the electrical outlet.
20. Regularly clean the filters to maintain efficiency. If the filters are not cleaned regularly, the units output performance and efficiency will decline and energy consumption will increase.
21. DO NOT operate the unit with a damaged power cord or plug, after it malfunctions, has been dropped or damaged.
22. Only use in the upright position on an even, flat surface. Unit must be positioned at least 24 inches (60 cm) from the nearest object in any direction.
23. Stop operation immediately if abnormal noise or odor is noticed. Contact a local service center.
24. Appliance is not to be used by children or persons with reduced physical, sensory or mental capabilities, or lack of experience and knowledge, unless they have been given supervision or instruction.
25. Children being supervised not to play with appliance.
26. That the appliance shall be installed in accordance with national wiring regulations.
27. If the supply cord is damaged, it must be replaced by the manufacturer, its service agent or similarly qualified persons in order to avoid a hazard.

**SAVE THESE INSTRUCTIONS**

## Assembly (604151)

### COMPONENT PARTS

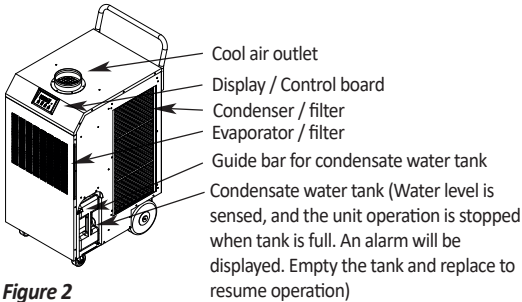

**Figure 2**  
Front and Right Side View

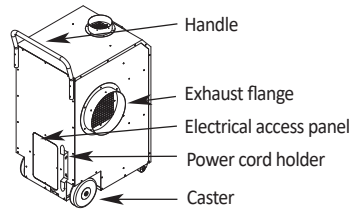

**Figure 3**  
Back and Left Side View

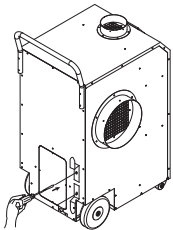

**Figure 4**

#### POWER CORD HOLDER

1. Take out the cord holder from the accessory box.
2. Place the cord holder on the back side of air conditioner.
3. Use screws (enclosed inside of accessory box with cord holder) to install the cord holder on the air conditioner as shown in Figure 4.

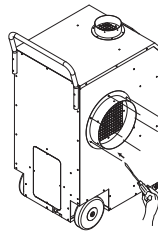

**Figure 5**

#### FAN EXHAUST FLANGE

1. Remove the fan exhaust flange from carton.
2. Place the fan exhaust flange on the air conditioner.
3. Use screws (enclosed inside of box with the fan exhaust flange) to install the fan exhaust flange on the air conditioners as shown in Figure 5.

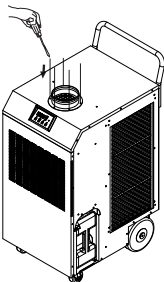

**Figure 6**

#### DISCHARGE DUCTS / SUPPLY AIR DUCT

1. Use screws (enclosed inside of box with cool air outlet hose(s)) to install the cool air outlet hose(s) on the air conditioner as shown in Figure 6.
2. Insert the flexible duct (150Ø : 6 inch) in the cool air outlet hose(s)

## Installation

### WARNINGS REGARDING PROPER LOCATION FOR INSTALLATION

**▲ WARNING** *Do not use the unit in explosive environments or in areas where flammable gas leakage may occur.*

**▲ WARNING** *Do not use the unit in areas where it will be exposed to rain or water.*

**▲ WARNING** *Do not use the unit in a corrosive atmosphere.*

**▲ WARNING** *Do not use the unit below 41°F or above 113°F.*

**▲ WARNING** *Do not install the unit on uneven or sloping surface. The unit may roll or topple over even if the casters are set to the locked position.*

## MOVING THE UNIT

Unlock the casters and push the unit using the side handles to a flat, level surface and set the caster brakes to the locked position.

## PLUGGING IN THE UNIT

Check the prongs and surface of the power cord plug for dust/dirt. If dust and/or dirt are present, wipe off with a clean, dry cloth.

Check the power cord, plug and prongs for damage or excess play.

If any damage or excess play is found, contact a qualified repair technician or a qualified electrician to perform replacement or repair of the power cord, plug or prongs.

**▲ WARNING** *If the power cord or plug is damaged, repair should only be performed by qualified electrical personnel.*

**▲ WARNING** *Do not connect / disconnect the power cord or attempt to operate buttons with wet hands. This could result in electrical shock.*

**NOTE:** Make sure the AC outlet is free of dirt, dust, oil, water, or any other foreign material. The unit is equipped with an approved NEMA plug configuration (604151: 5-20P) . The appropriate outlet must be used for each plug type.

## Operation

### CONTROL PANEL

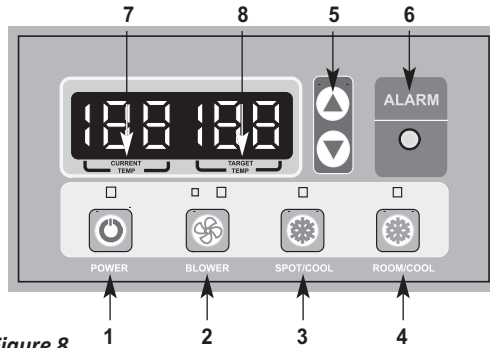

**Figure 8**

1. **POWER BUTTON:** Activates unit when POWER BUTTON is pressed (Fan starts on high speed). If power button is pressed during operation, unit stops.
2. **BLOWER BUTTON:** Changes fan speed from (Low) to (High) when pressed.
3. **SPOT/COOL BUTTON:** Activates compressor and begins producing cool air 5 seconds after button is pressed. Regulates temperature based on outlet cool air temperature.
4. **ROOM/COOL BUTTON:** Activates compressor and produces cool air 5 seconds after button is pressed. Regulates temperature based on inlet ambient air temperature.
5. **SET TEMP BUTTONS:** Change target temperature/data value by +/- 1. Press the SET TEMP BUTTONS to set temperature. Upper button is to heighten temperature and Lower button is to lower temperature.
6. **ALARM:** Alarm indicator lights (blinks) and indicates abnormal system operation. If Alarm occurs, only Eva fan activates. System operation stops when ALARM light is activated (blinks) longer than 3 minutes.
7. **CURRENT TEMP:** Displays current room temperature in display in Fahrenheit. (In Room Cool Mode only). SPOT/COOL Mode – Displays outlet (cool air) temperature during normal operations. In order to change °F to °C, press SPOT/COOL and ROOM/COOL buttons together for 2 seconds. C will blink 2 times and Figure will change to °C. ALARM codes blink and are displayed when abnormal operation occurs.

**NOTE:** Canadian version shows the temperature in Celsius first when you turn on the unit.

8. **TARGET TEMP:** Displays the unit set temperature for ROOM/COOL mode only.

**OFF-TIMER:** Enter to Timer Setting Mode if you press BLOWER Button and SPOT/COOL Button together for 1 seconds. Press UP/DOWN Button to set the timer until it shows the figure you want to set. After 5 seconds, the figure will be memorized and the compressor will stop after the time set.

**AUTO RESTART:** If the unit goes off due to an electrical interruption, the unit will automatically restart when the power resumes.

## Maintenance

### FILTER CLEANING (See Figures 9 and 10)

There are two filters in the unit. The evaporator filter is located at the front of the unit. The condenser filter is located at the side of the unit.

1. Open the front grill
2. Slide filter to the right side and use a vacuum cleaner to remove the dust from the filter
3. If the filter is heavily covered with dust and dirt, warm water and mild soap or neutral detergent can be used to wash the filter  
Do not use any other chemicals to clean filter, as they will likely damage the filter.
4. Dry the filter in a shaded area before reassemble it. Do not operate the unit without the filter installed and the filter guard in the closed position
5. Reassemble the clean filter and close the filter grill
6. To clean the condenser filter, lift up on the side filter from the middle bar slightly and then angle the filter outwards from the bottom and remove.
7. Use the same cleaning procedure as above (3-4)
8. To reassemble the condenser filter, place the top of the filter in the guide and slide the filter down until the bottom of the filter clears the frame. Then push the bottom of filter into the guide and let the filter gently fall inside the guide.

**NOTE: Clean the filter at least every 2weeks for effective cooling.**

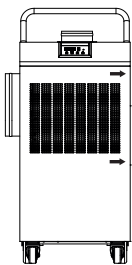

- Pull the filter frame to remove front filter
- Slide filter to the right side and use a vaccum cleaner to remove the dust from the filter.

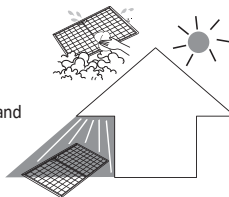

- Remove dust from the filter using a vacuum cleaner hose attachment.
- If required wash the filter in lukewarm water with a mild detergent. Leave to dry in a shaded area before reinstalling.

**Figure 9 – Removing Filters**

**Figure 10 – Removal of Dust**

**▲ WARNING**

**Do not operate without the filter fitted.**

**▲ WARNING**

**Do not operate the unit with a damaged cord or plug, after the unit malfunction, or if the unit has been dropped or damaged.**

- For your convenience, record the complete model number and product name (located on the Product Identification Plate), the purchase date, purchase location, serial number, and warranty period in the table below.
- Also, attach your purchase receipt as proof of purchase to this instruction manual for future reference.
- To ensure your product is covered by warranty, the complete faulty product along with your original purchase receipt must be provided at the place of purchase.

## Maintenance (Continued)

### SPRING REPLACEMENT (See Figure 11)

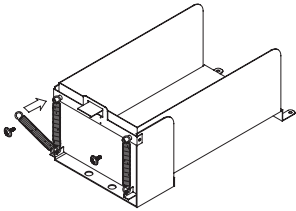

**Figure 11 – The process of spring replacement**







There are two springs on the rear of condensate water tank guide.

1. Release the screw on the spring hook.
2. Take off the spring hook, and then pull out the opposite spring hook from hole in the condensate water tank guide.
3. Replace with a new spring in reverse order.
4. Repeat this cycle for the other spring.

### SELF-DIAGNOSTIC CODES (See Table 1)

The alarm light is activated if abnormal operation occurs, and a code is displayed on the control panel. The compressor and condenser fan motor will stop operating. The evaporator fan will continue to run for 3 minutes. If the fault is rectified within 3 minutes, the unit will resume operation. If the fault persists for more than 3 minutes, the evaporator fan also stops. The fault must be rectified before the unit can resume normal operation.



<b>SELF-DIAGNOSTIC ALARM CODES</b>			
<b>Alarm Display</b>	<b>Problem</b>	<b>Cause</b>	<b>Corrective Action</b>
	Frost prevention sensor and Abnormal temperature sensor value	<ul style="list-style-type: none"> <li>Indoor heat exchanger temperature too low</li> <li>TH3 temperature sensor has a loose or broken connection</li> </ul>	<ul style="list-style-type: none"> <li>Do not use the air conditioner if ambient temperature is lower than 18°C (64°F)</li> <li>Contact a qualified service agent</li> </ul>
	Refrigerant high pressure switch	<ul style="list-style-type: none"> <li>Blocked air filter</li> <li>Blocked / kinked exhaust duct</li> <li>Ambient temperature is too high</li> </ul>	<ul style="list-style-type: none"> <li>Clean air filter</li> <li>Ensure exhaust duct is not blocked / kinked</li> <li>Do not use the air conditioner if ambient temperature is higher than 45°C (113°F)</li> </ul>
	Abnormal temperature sensor value	TH1(Outlet) temperature sensor has a loose or broken connection	Contact a qualified service agent
	Abnormal temperature sensor value	TH2(Inlet) temperature sensor has a loose or broken connection	Contact a qualified service agent
	Compressor overloaded	<ul style="list-style-type: none"> <li>Ambient temperature is too high</li> <li>Unstable voltage supply</li> <li>Defective compressor</li> </ul>	<ul style="list-style-type: none"> <li>Do not use the air conditioner if ambient temperature is higher than 113°F (45°C)</li> <li>Contact a qualified service technician</li> <li>Replace compressor</li> </ul>
	Condensate water level alarm	Condensate tank is full	<ul style="list-style-type: none"> <li>Empty the water tank</li> <li>After installation of the water tank, press the SPOT/COOL or ROOM/COOL button to resume operation</li> </ul>
	Drain pump alarm	Drain pump defective or improper hose connection (including kink or blockage)	<ul style="list-style-type: none"> <li>Check the hose connection and hose</li> <li>Replace drain pump</li> </ul>

**Table 1- Alarm Codes**

## Wiring Diagram

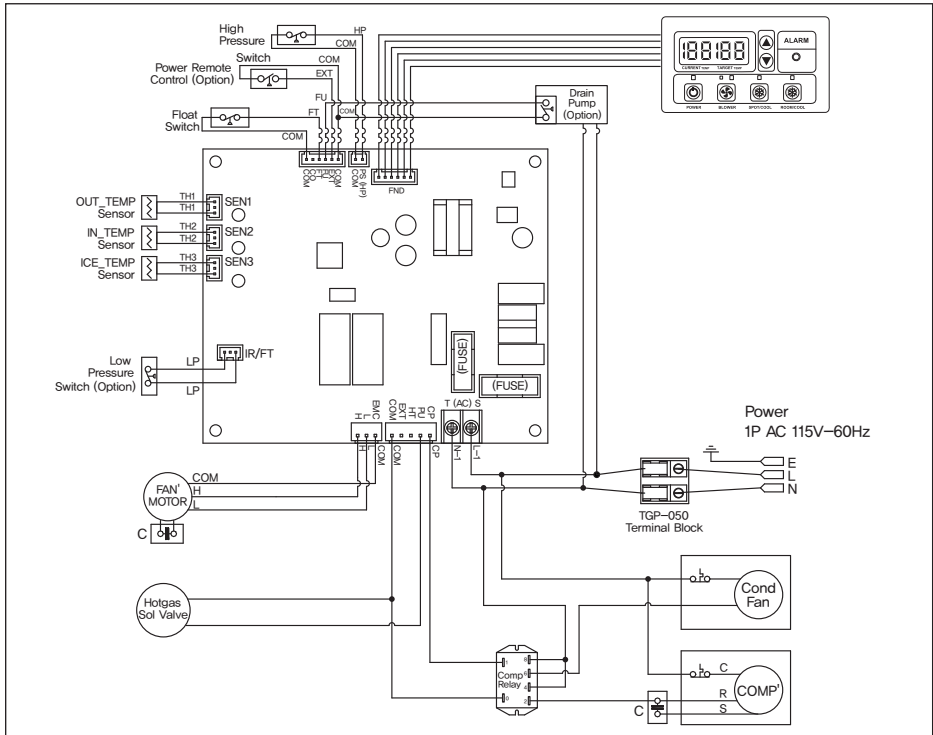

**Figure 12 - Circuit Wiring Diagram (604151)**

## Troubleshooting chart

Symptom	Possible Cause(s)	Corrective Action
Water leakage	High water level in condensate tank	Remove blockage from drain hose
The unit doesn't work	<ol style="list-style-type: none"> <li>1. Check the power supply to verify that power is available to the unit</li> <li>2. Verify that the power cord is connected</li> </ol>	<ol style="list-style-type: none"> <li>1. Reset the circuit breaker and restart the unit</li> <li>2. Connect power cord</li> </ol>
No cold air flows from the cold air outlet	<ol style="list-style-type: none"> <li>1. Ambient air cannot be properly cooled if the filter is dirty and not regularly cleaned</li> <li>2. Compressor will not work if the unit is turned off and on quickly.</li> <li>3. The ambient air temperature may be too high</li> </ol>	<ol style="list-style-type: none"> <li>1. Clean the filter</li> <li>2. Wait 2 minutes after unit is turned off before turning the unit back on.</li> <li>3. The temperature of the compressor can be higher when the ambient temperature is too high. The compressor will not work unless the ambient air temperature is within the acceptable operating range of the unit</li> </ol>
Water flow can be heard after compressor shuts off	No cause	Common to hear coolant flowing after unit shuts off
Alarm displays "FT" with less than half of condensate water in the tank Spring is possibly broken	Spring is possibly broken	Replace a new spring (See Maintenance page 8)

## LIMITED WARRANTY

**Global industrial ONE-YEAR LIMITED WARRANTY.** Global industrial PORTABLE AIR CONDITIONERS, MODELS COVERED IN THIS MANUAL, ARE WARRANTED BY Global industrial TO THE ORIGINAL USER AGAINST DEFECTS IN WORKMANSHIP OR MATERIALS UNDER NORMAL USE FOR ONE YEAR AFTER DATE OF PURCHASE. ANY PART WHICH IS DETERMINED TO BE DEFECTIVE IN MATERIAL OR WORKMANSHIP AND RETURNED TO AN AUTHORIZED SERVICE LOCATION, Global industrial DESIGNATES, SHIPPING COSTS PREPAID, WILL BE, AS THE EXCLUSIVE REMEDY, REPAIRED OR REPLACED BY Global industrial OPTION. FOR LIMITED WARRANTY CLAIM PROCEDURES, SEE "PROMPT DISPOSITION" BELOW. THIS LIMITED WARRANTY GIVE PURCHASERS SPECIFIC LEGAL RIGHTS WHICH VARY FROM JURISDICTION TO JURISDICTION.

**LIMITATION OF LIABILITY.** TO THE EXTENT ALLOWABLE UNDER APPLICABLE LAW, Global industrial LIABILITY FOR CONSEQUENTIAL AND INCIDENTAL DAMAGES IS EXPRESSLY DISCLAIMED. Global industrial LIABILITY IN ALL EVENTS IS LIMITED TO AND SHALL NOT EXCEED THE PURCHASE PRICE PAID.

**WARRANTY DISCLAIMER.** A DILIGENT EFFORT HAS BEEN MADE TO PROVIDE PRODUCT INFORMATION AND ILLUSTRATE THE PRODUCTS IN THIS LITERATURE ACCURATELY; HOWEVER, SUCH INFORMATION AND ILLUSTRATIONS ARE FOR THE SOLE PURPOSE OF IDENTIFICATION, AND DO NOT EXPRESS OR IMPLY A WARRANTY THAT THE PRODUCTS ARE MERCHANTABILITY, OR FIT FOR PARTICULAR PURPOSE, OR THAT THE PRODUCTS WILL NECESSARILY CONFORM TO THE ILLUSTRATIONS OR DESCRIPTIONS. EXCEPT AS PROVIDED BELOW, NO WARRANTY OF AFFIRMATION OF FACT, EXPRESSED OR IMPLIED, OTHER THAN AS STATED IN THE "LIMITED WARRANTY" ABOVE IS MADE OR AUTHORIZED BY Global industrial.

**Technical Advice and Recommendations, Disclaimer.** Notwithstanding any past practice or dealings or trade custom, sales shall not include the furnishing of technical advice or assistance or system design. Global industrial assumes no obligations or liability on account of any unauthorized recommendations, opinions or advice as to the choice, installation or use of products.

**Product Suitability.** Many jurisdictions have codes and regulations governing sales, construction, installation, and/or use of products for certain purposes, which may vary from those in neighboring areas. While attempts are made to assure that Global industrial products comply with such codes, Global industrial cannot guarantee compliance, and cannot be responsible for how the product is installed or used. Before purchase and use of a product, review the product applications, and all applicable national and local codes and regulations, and be sure that the product, installation, and use will comply with them.

Certain aspects of disclaimers are not applicable to consumer products; e.g., (a) some jurisdictions do not allow the exclusion or limitation of incidental or consequential damages, so the above limitation or exclusion may not apply to you; (b) also, some jurisdictions do not allow a limitation on how long an implied warranty lasts, consequently the above limitation may not apply to you; and (c) by law, during the period of this Limited Warranty, any implied warranties of implied merchantability or fitness for a particular purpose applicable to consumer products purchased by consumers, may not be excluded or otherwise disclaimed.

**Prompt Disposition.** A good faith effort will be made for prompt correction or other adjustment with the respect to any product which proves to be defective within limited warranty. For any product believed to be defective within limited warranty, first write or call dealer from whom the product was purchased. Dealer will give additional directions. If unable to resolve satisfactorily, write to Global industrial at the address below, giving dealer's name, address, date, and number of dealer's invoice, and describing the nature of the defect. Title and risk of loss pass to buyer on delivery to common carrier. If product was damaged in transit to you, file claim with carrier.