

Lista de piezas

Nota: El hardware proporcionado es para la instalación de paneles de yeso. Si se desea instalar en otros materiales, el hardware debe ser adquirido por otro medio.

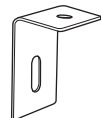

A x4

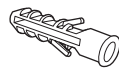

B x4

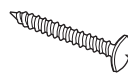

C x4



D x4

Herramientas Requeridas

- Cinta Métrica
- Línea de Tiza
- Taladro

- Broca de 1/4"
- Destornillador de Estrella
- Martillo

1 Deslice la bandeja en la ranura inferior del tablero. Trace dos líneas de tiza horizontales en las alturas indicadas desde el piso. Si va a instalarse en un muro, perforo 4 agujeros de 1/4" como se especifica.

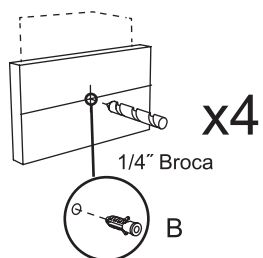

2 Inserte los anclajes de paneles de yeso B en los agujeros y luego conecte los soportes A en la parte inferior con el tornillo C, asegurándose de que el soporte esté en la posición más baja.

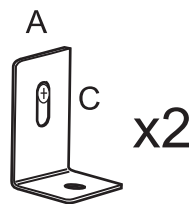

3 Instale los soportes A en la parte superior con el tornillo C asegurándose de que el soporte esté en la más alta posición. Apriete el tornillo lo más suficiente para que el soporte pueda ser ajustado hacia abajo con el martillo.

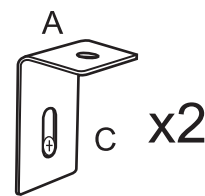

4 Coloque el tablero en los soportes inferiores asegurándose de centrarlo. Adjunte el soporte al tablero con el tornillo D.

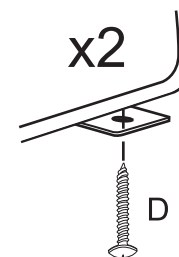

5 Ajuste los soportes superiores hacia abajo hasta que toquen la parte superior del tablero. Adjunte el soporte al tablero usando el tornillo D.

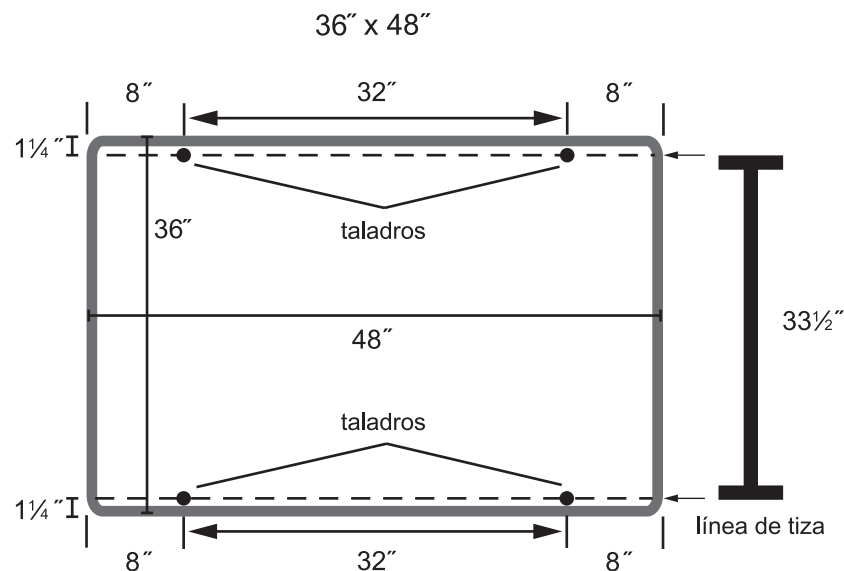
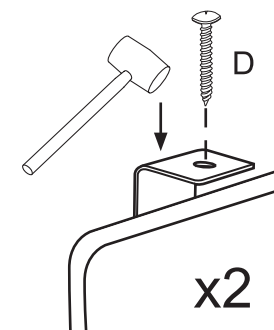



www.globalindustrial.com

US: 888-628-3466
Canada: 888-645-2986
Mexico: 01.800.681.6940
48" x 36" CALENDAR BOARD
Model: 695524 695815
ASSEMBLY INSTRUCTIONS

Parts List

Note: Hardware provided is for drywall installation. If attaching to other material fasteners are to be furnished by other.



A x4

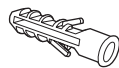

B x4

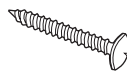

C x4



D x4

Tools Required

- Tape Measure
- Chalk Line
- Drill
- 1/4" Drill Bit
- Extended Drive Phillips
- Hammer

1 Slide tray into groove on bottom of wall board. Snap two horizontal chalk lines at the heights indicated from the floor. If attaching to drywall drill four 1/4" holes as specified.

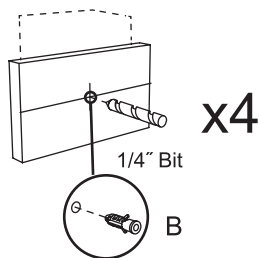

2 Insert drywall anchors B into holes then attach brackets A at the bottom with screw C making sure the bracket is in the lowest position.

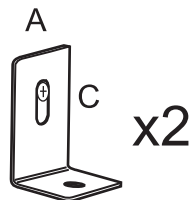

3 Attach brackets A at the top with screw C making sure the bracket is in the highest position. Tighten screw just enough so that the bracket can be tapped down with hammer.

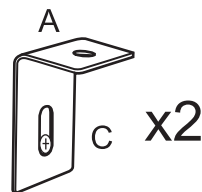

4 Place white board on lower brackets making sure to center it. Attach bracket to wallboard using screw D.

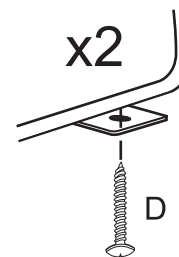

5 Tap the top brackets down so they are touching the top of the board. Attach bracket to wallboard using screw D.

