

CONNECT DOOR CUBE

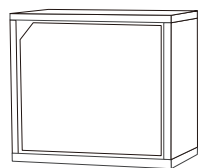

Included



8 Alignment Pins
4 connectors pins

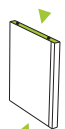

2 Vertical zBoards
adhesive strips on 2 edges

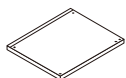

1 Bottom zBoard
with door pin slot

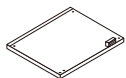

1 Top zBoard
with magnetic door stopper



1 Backer Board
thin and has no adhesive



1 zBoard Door

WARNING: CHOKING HAZARD
Small parts NOT for children under 3 years

Important

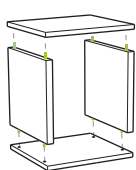

↑
THIS SIDE UP

Tip Start assembly from bottom to top.

DO NOT place unit on its side or back as it will compromise its structural integrity.



- Assemble your unit on a flat even surface, carpet not recommended
- Furniture is for indoor use only

- When moving your Way Basics furniture, lift from the bottom
- Make sure zBoard surfaces are clean and dry

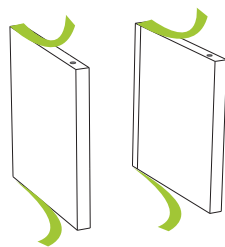

1 Carefully remove the 3M protective layer from adhesive.

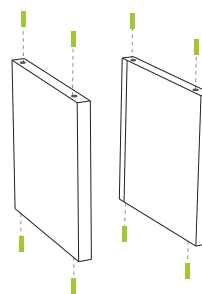

2 Place alignment pins in vertical zBoards.

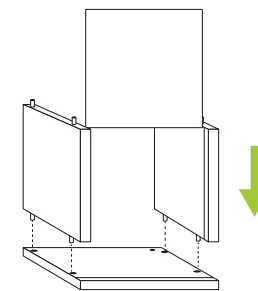

3 Align vertical zBoards and backer board to bottom zBoard.

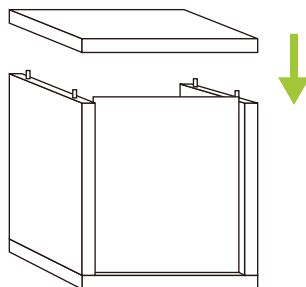

4 Align top zBoard.

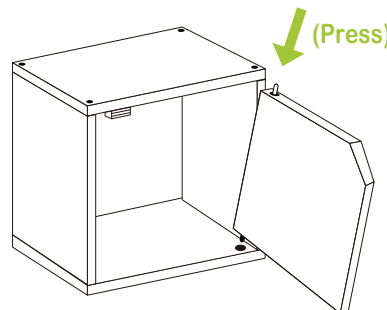

5 Orient door properly as shown and align bottom pin. Press on spring loaded top pin and insert.

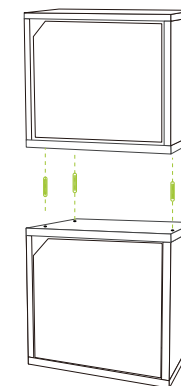

6 Join other connect cubes with connector pins! Visit links below for more details. Enjoy building possibilities!

Note Use included decals to cover the connector holes if not stacking cubes.



CONNECT OPEN CUBE

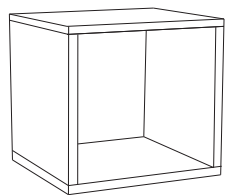

Included



8 Alignment Pins
4 connectors pins

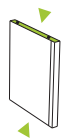

2 Vertical zBoards
adhesive strips on 2 edges

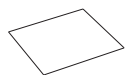

1 Backer Board
thin and has no adhesive

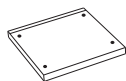

2 Horizontal zBoards
with grooves

WARNING: CHOKING HAZARD
Small parts NOT for children under 3 years

Important

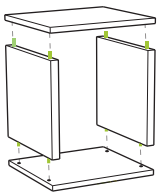

Tip Start assembly from bottom to top.

DO NOT place unit on its side or back as it will compromise its structural integrity.



- Assemble your unit on a flat even surface, carpet not recommended
- Furniture is for indoor use only

- When moving your Way Basics furniture, lift from the bottom
- Make sure zBoard surfaces are clean and dry

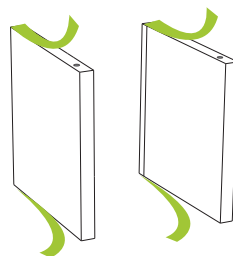

1 Carefully remove the 3M protective layer from adhesive.

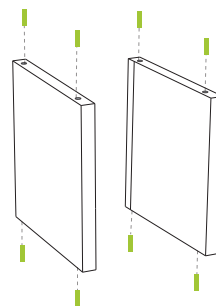

2 Place alignment pins in vertical zBoards.

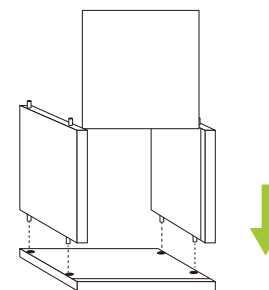

3 Align vertical zBoards and backer board to horizontal zBoard.

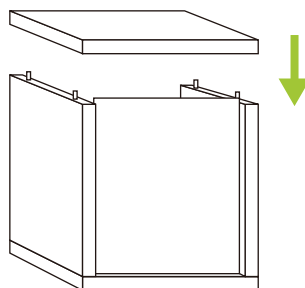

4 Align horizontal zBoard.

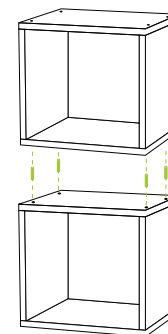

5 Join other connect cubes with connector pins!
Visit links below for more details. Enjoy building possibilities!

Note Use included decals to cover the connector holes if not stacking cubes.



CONNECT SHELF CUBE

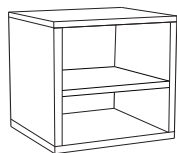

Included



12 Alignment Pins
4 connectors pins

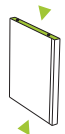

2 Vertical zBoards
adhesive strips on 2 edges

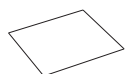

1 Backer Board
thin and has no adhesive

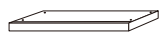

2 Horizontal zBoards
with grooves

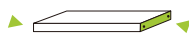

1 Middle zBoard
adhesive strips on 2 edges

WARNING: CHOKING HAZARD
Small parts NOT for children under 3 years

Important

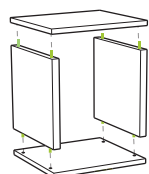

THIS SIDE UP

DO NOT place unit on its side or back as it will compromise its structural integrity.



- Assemble your unit on a flat even surface, carpet not recommended
- Furniture is for indoor use only
- When moving your Way Basics furniture, lift from the bottom
- Make sure zBoard surfaces are clean and dry



1 Carefully remove the 3M protective layer from adhesive.



2 Place alignment pins in middle zBoard and vertical zBoards.

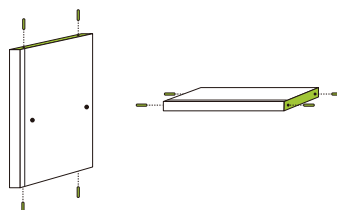

3 Align vertical zBoards to middle zBoard.

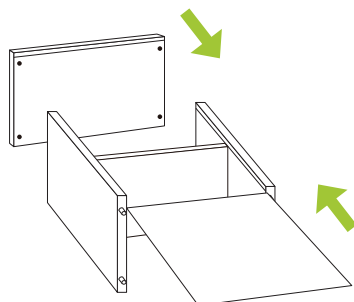
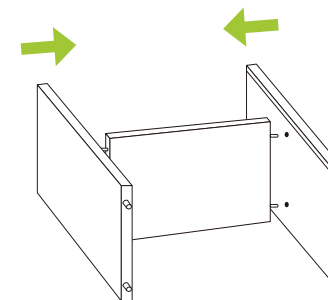

4 Align a horizontal zBoard and slide in backer board.

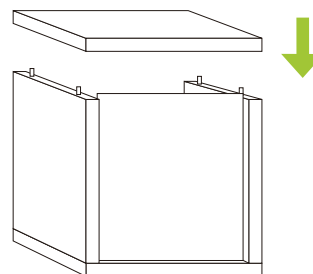

5 Align horizontal zBoard and press firmly to secure unit together.

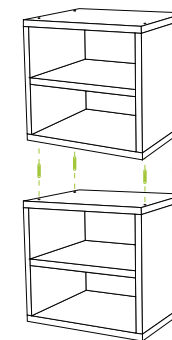

6 Join other connect cubes with connector pins! Visit links below for more details. Enjoy building possibilities!

Note Use included decals to cover the connector holes if not stacking cubes.

