



Model: **16-135L** Item #: _____ Date: _____

Project: _____ Qty: _____ Approved By: _____

8" Deck Mount Pitcher Filler

Royal Series Plumbing

Standard Features

- Pedestal with adjustable flange
- Green Push back activation arm
- 8" High from deck to spout tip
- Adjustable flow outlet (.25 gpm – 1.5 gpm)
- Continuous on position latch
- 1/2" Male NPS Inlet

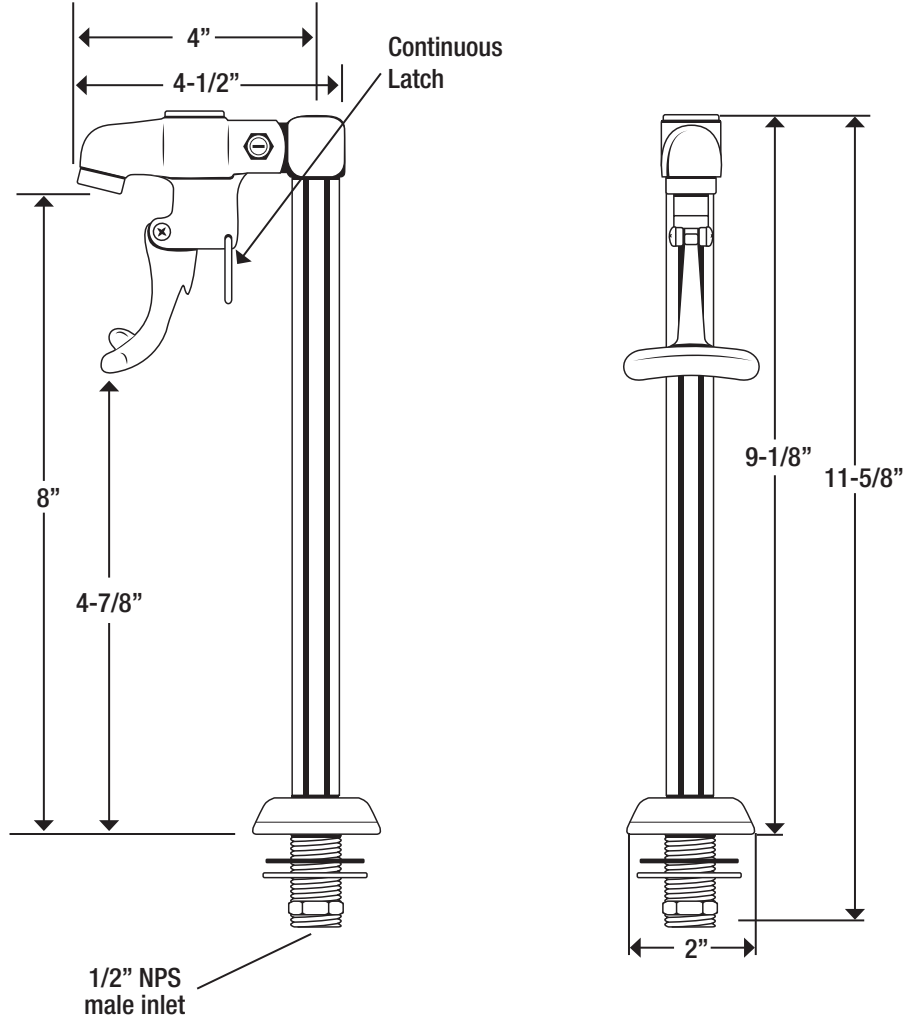

Product Compliance

- NSF-61 & NSF/ANSI 372
- ASME A112.18.1-2012/CSA B125.1-12
- Massachusetts Approved



WARNING: Plumbing connections should be made by qualified personnel who will observe all applicable plumbing, sanitary and safety codes.

California Proposition 65 Warning

Specifications

Water Inlet	1/2" Male NPS
Temp Range	40-140F
Pressure	20-125 psi
Adjustable Flow Rate	.25 GPM - 1.5 GPM at 60 psi
Material	Chrome Plated Brass
Weight	3 lbs