

Whynter 3.0 cu. ft. Energy Star Upright Freezer with Lock - Stainless Steel

Model # : CUF-301SS

INSTRUCTION MANUAL



Congratulations on your new Whynter product. To ensure proper operation, please read this Instruction Manual carefully before using this product. Keep this manual in a safe place for future reference.

Table of Contents

	PAGE
Safety Precautions	3 - 4
Parts and Accessories	5
Product Features / Technical Data	6
Installation	7 - 8
Operation and Controls	9 - 10
Reversing the Door Position	11
Cleaning and Maintenance	12 - 13
Troubleshooting	14 - 15
Warranty Information	16

Safety Precautions

WARNING

TO REDUCE THE RISK OF FIRE, ELECTRICAL SHOCK, OR INJURY WHEN USING YOUR UPRIGHT FREEZER, FOLLOW THESE BASIC PRECAUTIONS:

- Read all instructions before using the appliance.
- Never clean appliance parts with flammable fluids. The fumes can create a fire hazard. Do not use an excessively wet cloth, industrial solvents, and oil-based products to clean this appliance.
- To clean the upright freezer, use only mild detergents. Never use harsh chemicals or solvents.
- Do not store or use gasoline or any other flammable vapors and liquids in the vicinity of this or any other appliance. The fumes can create a fire hazard.
- Do not abuse, sit on, or stand on the appliance.
- This appliance is not intended for use by persons (including children with reduced physical, sensory or mental capabilities, or lack of experience and knowledge, unless they have been given supervision or instruction concerning use of the appliance by a person responsible for their safety
- Children should be supervised to ensure that they do not play with the appliance.
- Ensure the upright freezer is unplugged before cleaning or if not in use
- If the power cord is damaged, it must be replaced by the manufacturer or its service agent or a similarly qualified person in order to avoid a hazard.
- Use the upright freezer only for its intended function. This appliance is designed for household, non-commercial use only. Any other use will void the warranty.
- Do not plug this upright freezer into the power source before setup is completed.
- An empty upright freezer can be dangerous for children and small animals. If disposing of the upright freezer, remove gaskets, latches, and the entire upright freezer door from your unused appliance so that children or small animals cannot be trapped inside.
- The upright freezer is an electrical appliance. To avoid serious injury from electrical shock, do not operate the upright freezer with wet hands, while standing on a wet surface, or while standing in water.
- To avoid the risk of shock, the product should never be used in bathrooms, shower rooms, or in any other steamy or wet areas.
- During installation, the power supply must not be excessively or dangerously bent or flattened.
- Do not tamper with controls.
- Make sure the power plug is placed fully and firm into the power source. If the wall receptacle you intend to use is not adequately grounded or protected by a time delay fuse or circuit breaker, have a qualified electrician install an outlet that is appropriate to local electrical codes and requirements.
- Do not use multiple socket or an extension cord as it may overheat and become a risk of fire. Please ensure that the upright freezer is plugged directly into the electrical outlet.
- The cord should be secured behind the unit and should not be left exposed or dangling
- Make sure the power plug is clean before usage.
- Make sure hands are dry when connecting the power plug. The appliance is equipped with a three-prong grounded plug on the power cord for your protection. Never modify, remove or attempt to repair the power plug yourself.
- Never pull the power cord to disconnect the unit from an outlet. Grasp the plug directly and pull it from the outlet.
- Never lift or carry the upright freezer by the power cord.
- Keep the power cord away from heated surfaces.
- Do not repair, disassemble and/or modify the appliance by yourself.
- Always turn off the appliance when cleaning or transporting.

Safety Precautions

- Transport the appliance in an upright position only.
- Always place the appliance on even and hard and level surface.
- Close the freezer door immediately after putting in any items to maintain the internal temperature of the unit.
- Avoid placing the freezer near external heat sources or direct sunlight.
- Make sure the freezer is placed on a flat, level, and solid surface.
- Place your appliance on a hard and level floor that is strong enough to support it when it is fully loaded.
- Do not turn the freezer upside down, on its side, or 45° or more off level.
- Keep fingers out of the “pinch point” areas; clearance between the door and cabinet are necessarily small. Be careful closing the door when children are in the area
- Do not touch the cold surfaces in the freezer compartment when hands are damp or wet, skin may stick to these extremely cold surfaces
- Do not move this freezer without securing the door in a closed and latched position.
- Do not refreeze frozen foods which have thawed completely
- Performance may vary based on operational and ambient conditions.

ELECTRICAL CONNECTION

The power cord of this appliance is equipped with a 3-prong (grounding) plug which mates with a standard 3-prong (grounding) wall outlet to minimize the possibility of electric shock hazard from this appliance. Have the wall outlet and circuit checked by a qualified electrician to make sure the outlet is properly grounded. Where a standard 2-prong wall outlet is encountered, it is your personal responsibility and obligation to have it replaced with a properly grounded 3-prong wall outlet. Do not use an adapter. The freezer should always be plugged into its own individual electrical outlet which has a voltage rating that matches the rating plate.

A 115 Volt AC, 60 Hz, 15- or 20-amp fused, grounded electrical supply is required. This provides the best performance and also prevents overloading house wiring circuits which could cause a fire hazard from overheated wires. Never unplug your freezer by pulling on the power cord. Always grip plug firmly and pull straight out from the outlet. Repair or replace immediately all power cords that have become frayed or otherwise damaged. Do not use a cord that shows cracks or abrasion damage along its length or at either end. When moving the freezer away from the wall, be careful not to roll over or damage the power cord

EXTENSION CORD

Because of potential safety hazards, it is strongly recommended that you do not use an extension cord with this appliance. However, if you must use an extension cord, it is absolutely necessary that it be a UL/CUL-Listed, 3-wire grounding type appliance extension cord having a grounding type plug and outlet and that the electrical rating of the cord be 15 amperes and 115 volts. Failure to follow these instructions can result in fire, electric shock, or death.

THE MANUFACTURER DISCLAIMS ANY RESPONSIBILITY IF THE ABOVE INSTRUCTIONS ARE NOT FOLLOWED.

Parts and Accessories



BOTTOM REAR SECTION

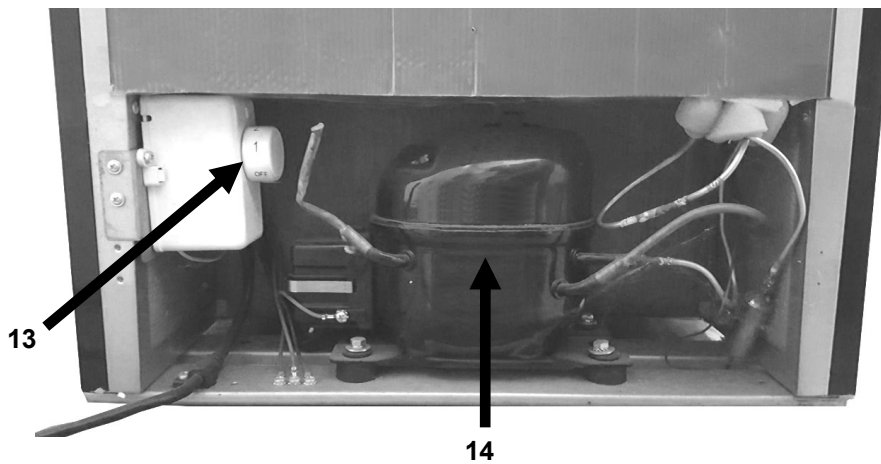

1. Door Handle	5. Cylinder Lock	9. Fast Freezing Coil Shelves (3)	13. Temperature Control Knob
2. Door	6. Small Leveling Leg	10. Slide-Out Freezer Wire Basket (1)	14. Compressor
3. Door Hinge Cover	7. Cooling Coils	11. Lock Latch	15. Keys
4. Large Leveling Leg	8. Temperature Sensor	12. Door Gasket/Seal	

Product Features / Technical Data

Ideal for any small space where cold storage is needed, the Whynter 3.0 cu. ft. upright freezer can also be used in the kitchen, offices, garages or basements. This space-saving compact upright freezer is designed with a flush back, allowing it to fit cleanly against the wall or into corners. The Whynter 3.0 cu. ft. upright freezer features a stainless steel reversible-swing door, adjustable temperature control, and a lock for securing the contents. As an ENERGY STAR rated appliance, this upright freezer will help you keep your energy costs down while providing efficient freezing solutions.

- Stainless steel reversible-swing door and black cabinet
- Powerful compressor cooling
- Equipped with 3 fast freezing coil shelves (not adjustable)
- Mechanical temperature control
- Recessed handle provides a flush finish with the door
- Temperature Range: -11°F - 10.4°F
- One removable slide out basket shelf
- Cylinder lock and two keys
- Freestanding setup (clearance around the unit is needed)
- Manual Defrost

TECHNICAL DATA

MODEL :	CUF-301BK
Storage Volume	3.0 cu. ft.
Temperature Control Range	-11°F - 10.4°F
Net Weight	57 lbs
Gross Weight	66 lbs
Unit Dimensions	20" W x 21" D x 34" H
Packaging Dimensions	21" W x 23" D x 35" H
Refrigerant	R600a
Estimated Yearly Electricity Use	240 kWh
Noise Level	≤42dB
Certification	Energy Star rated
UPC	852749006993



Excessive Weight Hazard

Two or more people should move and install upright freezer. Failure to do so can result in back or other injury.

REMOVE PACKAGING MATERIALS

IMPORTANT: Do not remove any permanent instruction labels or the data label on your upright freezer

REMOVE TAPE AND GLUE FROM YOUR UPRIGHT FREEZER BEFORE USING

- To remove any remaining tape or glue, rub the area briskly with your thumb. Tape or glue residue can also be easily removed by rubbing a small amount of liquid dish soap over the adhesive with your fingers. Wipe with warm water and dry.
- Do not use sharp instruments, rubbing alcohol, flammable fluids, or abrasive cleaners to remove tape or glue. These products can damage the surface of your upright freezer.

CLEANING BEFORE USE

- After you remove all of the packaging materials, clean the inside of your upright freezer before using it.

INSTALLATION CLEARANCES

Your upright freezer should be conveniently located for day-to-day use in a dry, well-ventilated room. Do not install the upright freezer where the temperature will go below 50°F or above 90°F, because it will not maintain proper temperatures. Be sure to install your upright freezer on a floor strong enough to support it when it is fully loaded.

FREESTANDING INSTALLATION

A freestanding installation will allow you to install the upright freezer in any place you desire provided that the required clearance space around the appliance is respected. In every setting, there must be adequate ventilation and access for service. Never install or operate the unit in an enclosed area, such as a closed cabinet.

- Before connecting the upright freezer to the power source, let it stand upright for approximately 4 hours. This will reduce the possibility of a malfunction in the cooling system from handling during transportation.
- The normal operation of the upright freezer depends on heat radiation from the condenser. Allow at least 6 inches of space between the back and sides of the appliance, which allows the proper air circulation to cool the compressor and condenser. The installation should allow the upright freezer to be pulled forward for servicing if necessary.
- This unit **MUST** be installed in an area protected from the elements, e.g., wind, rain, water spray or drips. Do **NOT** use the upright freezer in outdoor setting.
- The upright freezer should not be located next to ovens, grills or other high heat resources.
- Too much humidity in the air will cause frost to form quickly on the evaporator requiring more frequent defrosting of the upright freezer.
- Avoid locating the appliance in area that may be exposed to excessive moisture.
- The upright freezer must be installed with all electrical requirements followed.
- The unit should be located on a hard and level surface that can support the unit when it is full. It is important for the upright freezer to be level in order to work properly. If needed, you can adjust the height of the upright freezer by turning the leveling legs. See the “Leveling the Upright Freezer” section (page 8).

Installation

- A standard electrical supply (115 VAC only, 60 Hz, 10A), properly grounded in accordance with National Electrical Code and local codes and ordinances is required.
- **IMPORTANT:** Do not kink or pinch the power supply cord between the upright freezer and wall or cabinet.

MOVEMENT OF YOUR APPLIANCE

- Position the upright freezer in a dry and well-ventilated place. Keep the upright freezer away from direct sunlight, heaters, and corrosive gases or chemicals.
- Clean the interior surface with lukewarm water using a soft cloth.
- Place your appliance on a hard and level floor that is strong enough to support it when it is fully loaded.
- If the appliance is needed to be lifted, two or more people should move upright freezer. Failure to do so can result in back or other injury.
- We do not recommend installing the appliance on carpet.

LEVELING THE UPRIGHT FREEZER

It is important for the upright freezer to be leveled in order to work properly. It can be raised or lowered by turning the two leveling legs on the bottom of the appliance. If the upright freezer is not leveled during installation, the door may not close or seal properly, causing cooling, frost, or moisture problems. It is very important that the upright freezer is at level in order to function properly.

NOTE: This upright freezer comes with 2 leveling legs (1 large, 1 small)

We recommend using a carpenter's level to check the machine.

1. Place a carpenter's level on top of the product to see if the upright freezer is level from front to back and side to side.
2. Adjust the height of the legs as follows:
 - Turn the leveling leg to the right to lower that side of the upright freezer
 - Turn the leveling leg to the left to raise that side of the upright freezer

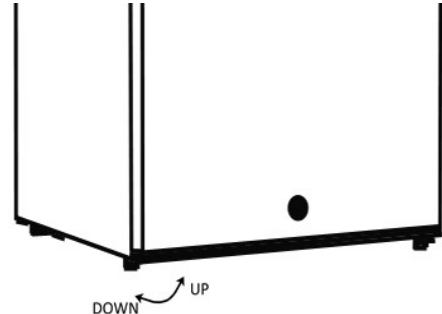

Operation and Controls

FAST FREEZING COIL SHELVES

This upright freezer is equipped with 3 freezing coil shelves. These shelves provide direct contact to freeze items quickly and allow cold air to constantly circulate throughout the freezer. Use these shelves for foods to be frozen, placing containers, or packages flat on the shelf.

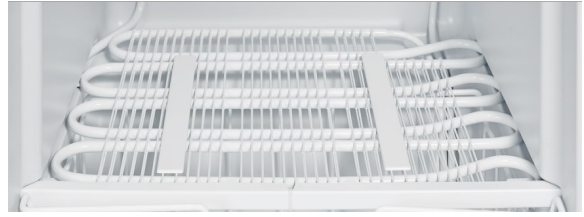

WARNING: Do not use sharp metal objects such as ice picks or scrapers to clean the shelves. This could damage the shelves and reduce its cooling ability. These shelves are not adjustable.

TEMPERATURE CONTROL

The temperature in the upright freezer is controlled by the temperature control knob. The temperature control knob is located in the compressor compartment at the back of the upright freezer. To operate this control, turn the temperature control knob up or down to regulate the temperature inside the upright freezer. The “1 – 6” numbers and “OFF” markings on control knob indicates the different temperature settings. Position “1” being the warmest and position “6” being the coldest.

NOTE: The temperature will not go above freezing even when unit is set to "1" setting.

STORING FROZEN FOOD

For safe food storage, allow 4 hours for the freezer to cool down completely. The freezer will run continuously for the first several hours. Foods that are already frozen may be placed in the freezer after the first few hours of operation.

- Unfrozen food should NOT be placed in the freezer until it has operated for 4 hours. Allow several hours after each one-step adjustment for the freezer temperature to stabilize.
- When loading the freezer, freeze only 3 pounds of fresh food per cubic foot of space at a time. Distribute packages evenly throughout the freezer.
- Storage recommendation printed on the packaging of frozen food by the manufacturers should be always be followed.

FREEZING FRESH FOOD

Ensure that your freezing operations are carried out under the most sanitary conditions as freezing alone does not sterilize the food.

- It is advisable to freeze the food by packing it into separate meal portions and not in bulk form. Never put hot or warm food into the upright freezer.
- Prior to storing the frozen food, pack it in plastic bags, aluminum sheets or freezing containers and place into the upright freezer.
- Fresh foods should not be stored together with frozen foods.
- When the temperature is set below 32°F, do not keep glass-bottled drinks such as beer or soda, as the glass may shatter and canned items may burst.
- Do not use this upright freezer as a refrigerator when the ambient temperature is 41°F as food can become frozen.

NOTE: For best performance, leave enough space inside the upright freezer cabinet for air to circulate around the packages..

DEFROSTING

Under most ambient conditions, the appliance does not need to be defrosted. In cold ambient temperatures and/or high humidity, some frost may build up. To defrost the appliance, set the temperature control knob to “OFF”, remove frozen or perishable items and defrosting should occur in a few hours. After defrosting, return the temperature control knob to the desired position. For faster defrosting, remove all items from the appliance, unplug the appliance and leave the door open. Never use a knife or other metal instrument to scrape ice/frost from the evaporator or coil shelves.

NORMAL SOUNDS

Your upright freezer may make sounds that are not familiar to you. Hard surfaces like the some flooring and walls can make the sounds seem louder than they actually are. The following describes the kinds of sounds that may be new to you a description of the cause of the sound.

- Rattling noises may come from the flow of the refrigerant or the water line, items stored on top of the up-right freezer can also make noises.
- The high efficiency compressor may make a pulsating or high-pitched sound.
- Noise emitted by the cooling fan on the condenser is a normal function.
- It is normal for the fan in the power supply to run all the time.
- As each cycle ends, you may hear a gurgling sound due to the refrigerant flowing in your upright freezer.
- The surface temperature of the compressor can reach 158 - 194°F when running.

Reversing the Door Position

Caution: To avoid injury to yourself and/or property, we recommend someone assist you during the door reversal process.

1. Start by removing the bottom hinge from the bottom of the freezer. Unscrew the two screws from the bottom hinge. Remove the leg from opposite side. Slide the door down, away from the hinge pin located on the top of the door.

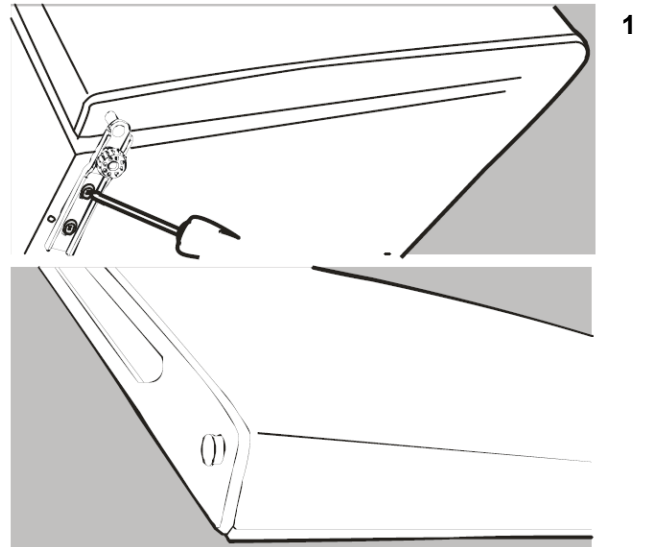

2. Remove the top hinge cover from door first. Then unscrew the two screws from top door hinge and replace on the other side.

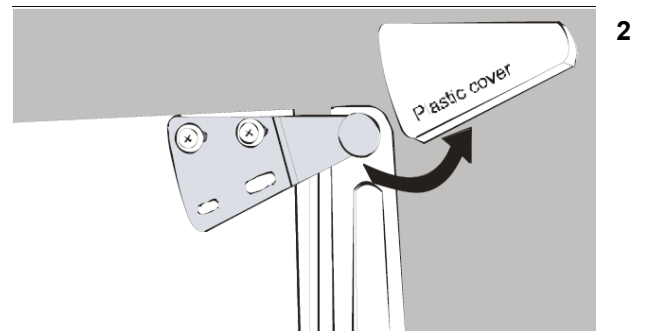

3. To install the top hinge on the left side of the appliance, secure the two screws through the hinge and into the top of the appliance. Slide the door back on to the top hinge. Ensure the door is face up. Replace the top hinge cover on the top hinge by pressing down until it clicks into position.

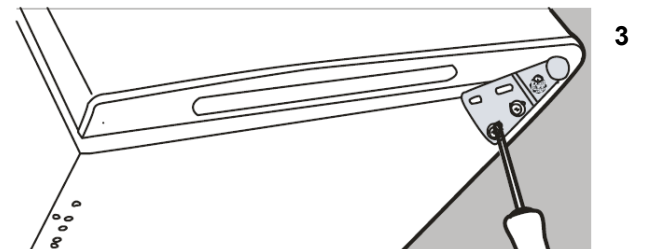

4. Screw the bottom hinge into place on the new side. Replace the leg on the other side.

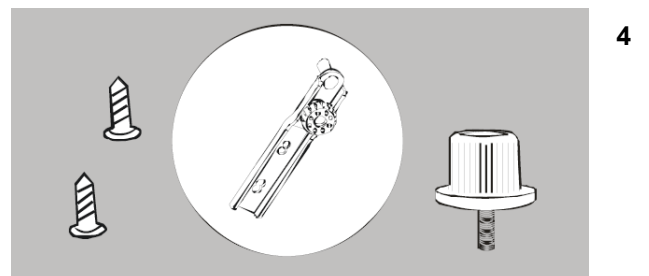

5. Ensure the door is aligned horizontally and vertically and that the seal is closed on all sides before finally tightening the bottom hinge. Re-adjust the leveling leg.

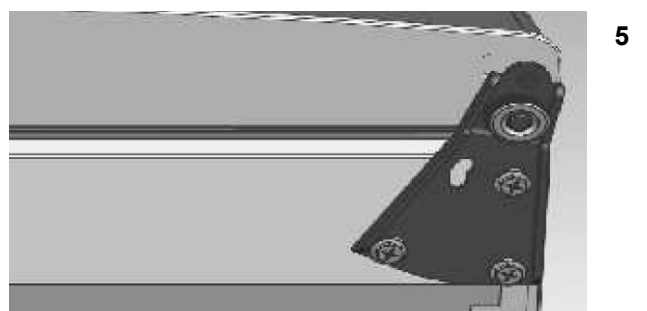

Cleaning and Maintenance

CLEANING

Outside/Exterior

- Wipe with a clean cloth lightly dampened with appliance polish wax or mild liquid dishwashing detergent. Dry and polish with a clean, soft cloth.
- Do not wipe the upright freezer with a soiled dishwashing cloth or wet towel. Do not use scouring pads, powdered cleaners, bleach, or cleaners containing bleach.

Inside

- Use warm water and baking soda solution—about a tablespoon of baking soda to a quart of water. Rinse thoroughly with water and wipe dry.
- Do not use cleaning powders or other abrasive cleaners. An open box of baking soda in the upright freezer will absorb stale freezer odors. Change the box every three months.
- An open box of baking soda in the freezer will absorb stale freezer odors. Change the box every three months

PROLONGED OFF PERIODS

If the upright freezer is not to be used for a long period of time, disconnect upright freezer from main power supply. Clean and dry the inside as instructed. Leave the upright freezer door open to prevent any mold and mildew growth.

Usage Tips:

- Keep the upright freezer's door closed as much as possible. Try not to open the door too frequently, especially when weather is hot and humid
- Ensure that the unit has sufficient clearance for ventilation
- For normal household use, it is recommended to set the temperature in the middle setting.
- Before loading the upright freezer with an item, make sure they are cooled to ambient temperature.
- Ice and frost layer increase energy consumption, defrost when frost is 3-5 mm thick.

PREPARING FOR VACATION

To maintain upright freezer in operation during vacations, be sure your house power is not turned off. For extended vacations or absences, you may prefer to move your frozen foods to a storage locker temporarily. If your upright freezer is to be left empty, disconnect power cord plug from power source. To prevent formation of odors, place open box of baking soda in upright freezer and leave upright freezer door open.

POWER INTERRUPTIONS

If the electricity goes off for a short period, keep the door closed to help food stay cold and frozen. If the power will be out for a longer period of time, remove food from the appliance and store it in a frozen food locker.

NOTE: If the appliance is unplugged, encounters a power interruption, or is turned off, you must wait 3 -5 minutes before restarting the appliance. If attempted to restart before this time delay, the appliance may not start.

IN CASE OF EXTENDED POWER FAILURE

- Keep freezer door closed. Your freezer will keep food frozen for 24 hours provided warm air is not admitted.
- If freezer is out of operation for 24 hours or more, add dry ice. Leave ice in large pieces. Add more ice as required.
- If dry ice is not available, move food to frozen locker temporarily—until power is restored

NOTE: Handling of dry ice can cause freezing of the hands—gloves or other protection is recommended.

Cleaning and Maintenance

ENERGY SAVING TIPS

The upright freezer should be located in the coolest area of the room, away from heat-producing appliances or heating ducts, and out of direct sunlight. Let hot foods cool to room temperature before placing in the upright freezer. Overloading the upright freezer forces the compressor to run longer. Foods that freeze too slowly may lose quality or spoil. Be sure to wrap foods properly, and wipe containers dry before placing them in the upright freezer. This cuts down on frost buildup inside the upright freezer

Freezer shelves should not be lined with aluminum foil, wax paper or paper toweling. Liners interfere with cold air circulation, making the upright freezer less efficient. Organize and label food to reduce door openings and extended searches. Remove as many items as needed at one time, and close the door as soon as possible.

Troubleshooting

Many common upright freezer problems are easily resolved. Try the troubleshooting suggestions below to see if the problems can be resolved before having to contact the service department.

Problem	Possible Causes	Solutions
The machine won't operate	<ul style="list-style-type: none"> • The upright freezer is unplugged • The voltage is not in the correct range • Too many appliances running form the same power circuit 	<ul style="list-style-type: none"> • Push the plug completely into the power source • Make sure that the upright freezer runs on a dedicated power source that can support the maximum power consumption of the upright freezer • Run the upright freezer on a dedicated power source
Noise during operation	<ul style="list-style-type: none"> • The legs are not leveled • Certain sounds are normal 	<ul style="list-style-type: none"> • Make sure legs are properly installed • See "Normal Sounds"
The compressor runs for 1 to 5 minutes and stops	<ul style="list-style-type: none"> • The voltage is not in the correct range 	<ul style="list-style-type: none"> • Unplug and restart when the power is normal
The compressor runs but the inner liner does not get very cold	<ul style="list-style-type: none"> • The ambient temperature is too high • The system is blocked 	<ul style="list-style-type: none"> • If temperature is higher than 90°F, the unit need longer to cool to the set temperature • Contact Whynter Service Department via email at service@whynter.com
The upright freezer does not cool sufficiently	<ul style="list-style-type: none"> • Freezer door being opened frequently • Freezer door left open for a while • Not enough adequate clearance • Freezer is overfilled • Ambient temperature is too high 	<ul style="list-style-type: none"> • Refrain from opening the upright freezer door recurrently • Make sure to close upright freezer door • Follow recommended clearance measurements • If temperature is higher than 90°F, the unit need longer to cool to the set temperature
The compressor does not run	<ul style="list-style-type: none"> • The controller is faulty (the power indicator is not on) • The temperature is set too high and the ambient temperature is too low 	<ul style="list-style-type: none"> • Contact Whynter Service Department via email at service@whynter.com • Set the upright freezer to a lower temperature
Door does not fully close	<ul style="list-style-type: none"> • Legs are not properly leveled • Stored items holding door open 	<ul style="list-style-type: none"> • See "Leveling the Upright Freezer" • Move stored item to a different location
Food defrosting	<ul style="list-style-type: none"> • Freezer is unplugged • Fuse blown • Freezer door being opened frequently • Freezer door left open for a while 	<ul style="list-style-type: none"> • Push the plug completely into the power source • Replace fuse or reset the breaker • Check to see if an object is holding the door open
Excessive frost buildup	<ul style="list-style-type: none"> • Door left open too frequent or too long door openings • High humidity 	<ul style="list-style-type: none"> • Check to see if an object is holding the door open • Open the door less often

Troubleshooting

Many common upright freezer problems are easily resolved. Try the troubleshooting suggestions below to see if the problems can be resolved before having to contact the service department.

Problem	Possible Causes	Solutions
Freezer external surface is warm	<ul style="list-style-type: none">• The external upright freezer walls can be as much as 30°F warmer than room temperature	<ul style="list-style-type: none">• This is normal while the compressor works to transfer heat from inside the upright freezer cabinet
Moisture forms on inside upright freezer walls	<ul style="list-style-type: none">• Weather is hot and humid, which increases internal rate of frost buildup• Door may not be seating properly• Door is kept open too long, or is opened too frequently	<ul style="list-style-type: none">• This is normal• Check door installation• Open the door less often
Odors in upright freezer	<ul style="list-style-type: none">• Interior needs to be cleaned• Food with strong odors are in the upright freezer	<ul style="list-style-type: none">• Clean interior with sponge, warm water, and baking soda

ONE YEAR LIMITED WARRANTY

This Whynter Upright Freezer is warranted, to the original owner within the 48 continental states, for one year from the date of purchase against defects in material and workmanship under normal use and service. When making a warranty claim, please have the original bill or invoice of purchase with purchase date available. Should your Whynter Upright Freezer prove defective within one year from the date of purchase, return the defective part or unit, freight prepaid (within two months of purchase; after two months to one year, customer will be responsible for freight cost to Whynter's service department), along with an explanation of the claim to Whynter LLC. A return authorization number issued by Whynter is required for all warranty claims and returns. Please package your Whynter Upright Freezer carefully in its original packaging material to avoid damage in transit. The original box and packaging material should be retained, as Whynter is not responsible for the cost of replacement packaging. Under this warranty, Whynter will repair or replace any parts found defective at our discretion. This warranty is not transferable. After the expiration of the warranty, the cost of labor and parts will be the responsibility of the original owner of the unit.

THIS WARRANTY DOES NOT COVER:

- Acts of God, such as fire, flood, hurricanes, earthquakes and tornadoes.
- Improper power supply such as power surge, low voltage, defective household wiring or inadequate fuses.
- Use in commercial or industrial applications
- Damage, accidental or otherwise, to the Whynter Upright Freezer while in the possession of a consumer not caused by a defect in material or workmanship;
- Damage caused by consumer misuse, tampering, or failure to follow the care and special handling provisions in the instructions.
- Damage to the finish of the case, or other appearance parts caused by wear.
- Damage caused by repairs or alterations to the product by anyone other than authorized by the manufacturer.
- Removal, Replacement Packaging, Freight and Insurance cost for the warranty service.

DISCLAIMER OF IMPLIED WARRANTIES; LIMITATION OF REMEDIES CUSTOMER'S SOLE AND EXCLUSIVE REMEDY UNDER THIS LIMITED WARRANTY SHALL BE PRODUCT REPAIR OR REPLACEMENT AS PROVIDED HEREIN. CLAIMS BASED ON IMPLIED WARRANTIES, INCLUDING WARRANTIES OF MERCHANTABILITY OR FITNESS FOR A PARTICULAR PURPOSE, ARE LIMITED TO ONE YEAR OR THE SHORTEST PERIOD ALLOWED BY LAW, BUT NOT LESS THAN ONE YEAR. WHYNTER SHALL NOT BE LIABLE FOR CONSEQUENTIAL OR INCIDENTAL DAMAGES SUCH AS PROPERTY DAMAGE AND INCIDENTAL EXPENSES RESULTING FROM ANY BREACH OF THIS WRITTEN LIMITED WARRANTY OR ANY IMPLIED WARRANTY. SOME STATES AND PROVINCES DO NOT ALLOW THE EXCLUSION OR LIMITATION OF INCIDENTAL OR CONSEQUENTIAL DAMAGES, OR LIMITATIONS ON THE DURATION OF IMPLIED WARRANTIES, SO THESE LIMITATIONS OR EXCLUSIONS MAY NOT APPLY TO YOU. THIS WRITTEN WARRANTY GIVES YOU SPECIFIC LEGAL RIGHTS. YOU MAY ALSO HAVE OTHER RIGHTS THAT VARY FROM STATE TO STATE.

**Please retain the original proof of purchase in order to obtain warranty services.
Warranty begins from the original date of purchase.**

To obtain service or information, contact

Whynter LLC via email at support@whynter.com or call

866-WHYNTER.

Product contents and specifications may change without notice.

Copyright © 2020 Whynter LLC

WWW.WYNTER.COM