

Nantucket Window Box Instructions

MIS020 r4

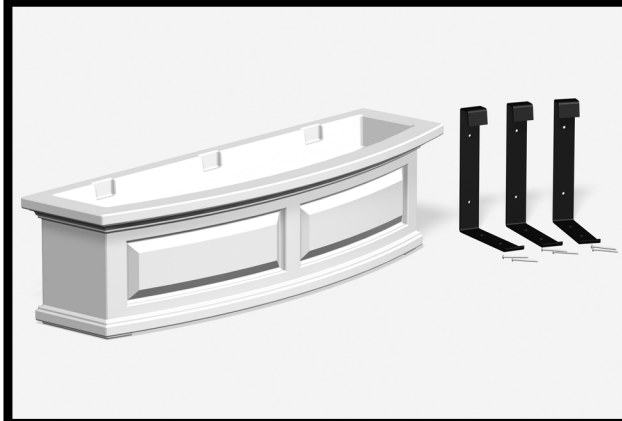

PACKAGE CONTENTS: Nantucket Window Box, Steel Wall Mount Brackets (2 for 2ft, 3 for 3ft, 3 for 4ft, and 4 for 5ft), and 2in screws (2 screws per wall mount bracket)

DIMENSIONS: 11.7"D x 10.2"H x (2', 3', 4', or 5' Lengths)

IMPORTANT NOTE:

- Do not overload the patio planters. Lightweight fillers and potting mixes are recommended.

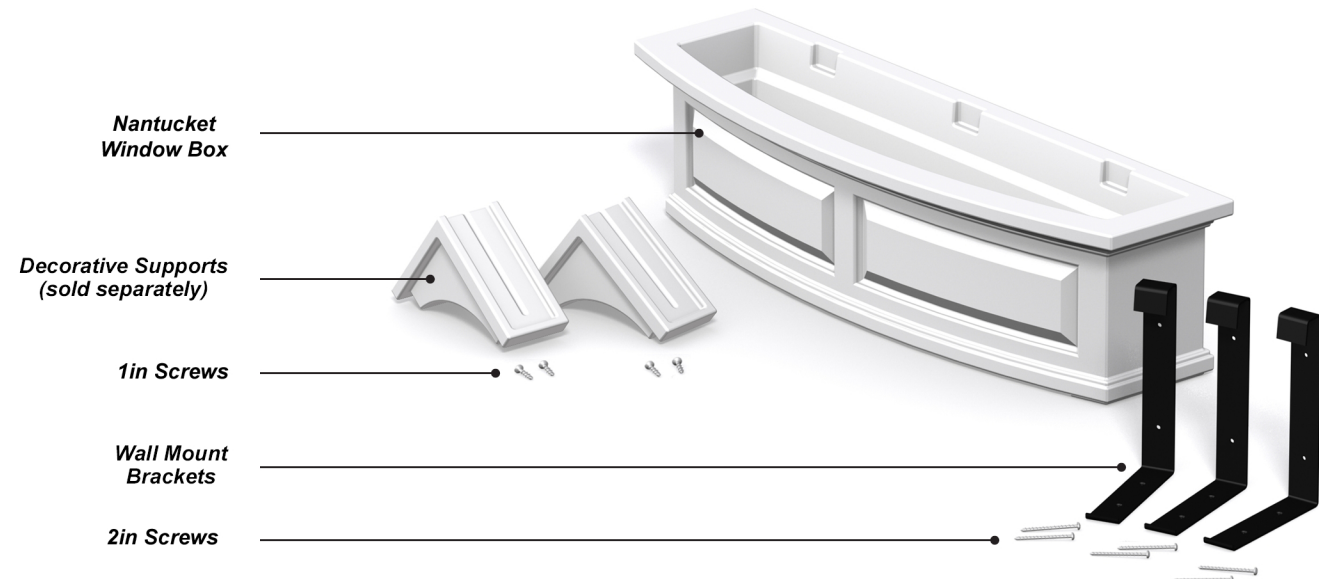

Tools Required:

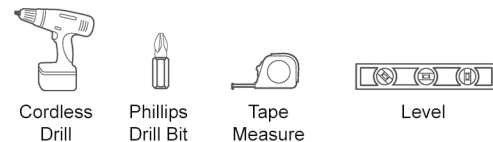

General Information:

- Read instructions carefully before beginning assembly.
- The Nantucket window boxes are suitable for flowers, herbs, vegetables, and small plants.
- To clean the product use standard house hold cleaners, for best results use a power washer.
- The molded polyethylene construction is designed to withstand cold temperatures but you may wish to winter store the planter in a shed or garage to offer the best protection from extreme cold.
- Wall mount brackets include screws for general mounting applications; however when installing on brick and concrete, masonry screws or anchors are required.

In the event of missing or defective parts, please email info@gomayne.com or call our customer service department toll free at 866-363-8834 (available Monday through Friday, 8am-5pm EST).

MAYNE[®]
Outdoor Products of Distinction
www.gomayne.com

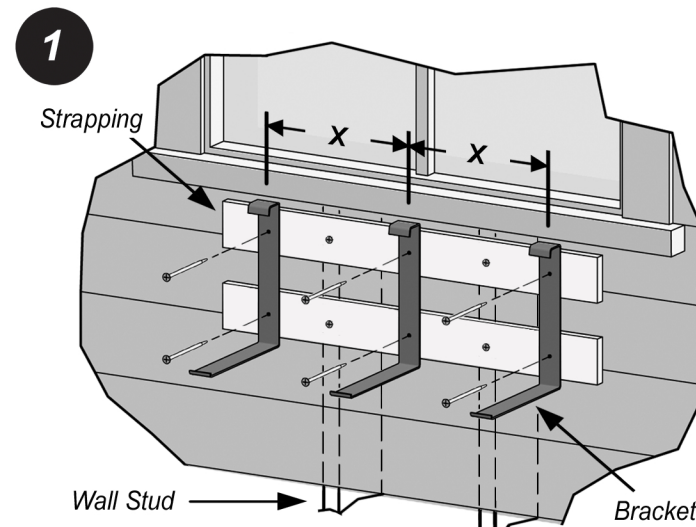

Secure the brackets to the wall using the screws provided. For concrete or brick installations masonry fasteners are recommended (not included). For installation on siding we recommend the use of strapping to add extra strength (shown above). Fasten the boards to the studs and then attach the wall mount brackets to the boards as shown above. Bracket spacing varies for each size of window box:

- 2 Foot Window Box - 2 brackets @ 12" spacing (on center)
- 3 Foot Window Box - 3 brackets @ 10" spacing (on center)
- 4 Foot Window Box - 3 brackets @ 16" spacing (on center)
- 5 Foot Window Box - 4 brackets @ 14" spacing (on center)

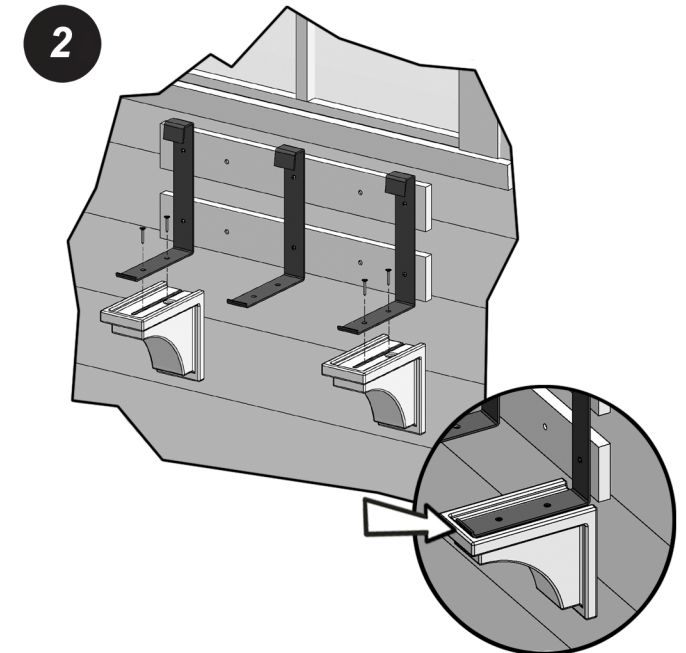

Optional Decorative Brackets (sold separately). Secure the decorative brackets to the bottom of the wall mount brackets using two 1 inch screws. The front lip of wall mount bracket should sit flush against the inside face of the decorative bracket (indicated by the arrow). The molded brackets are only decorative so there is no need to over tighten the screws.

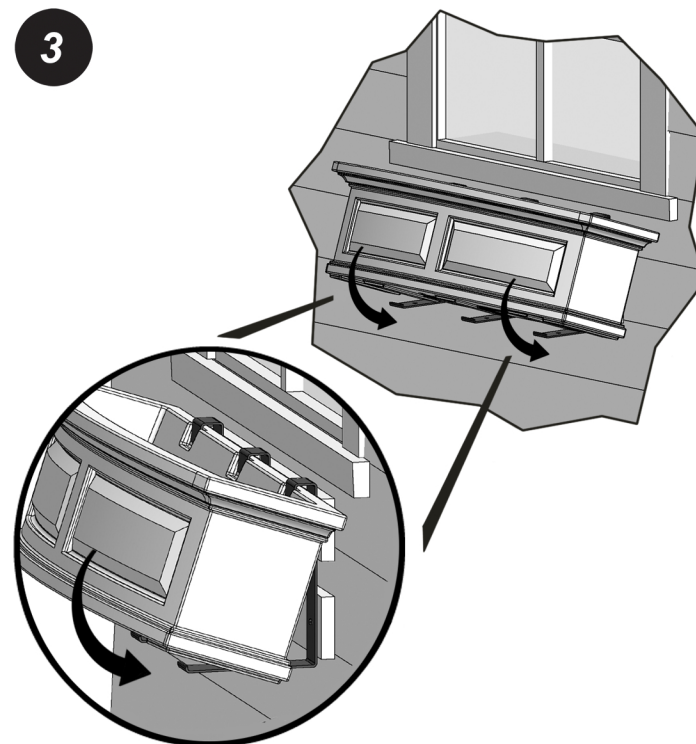

Tip the planter box into the brackets as illustrated ensuring the lips of the brackets fit into the molded grooves.

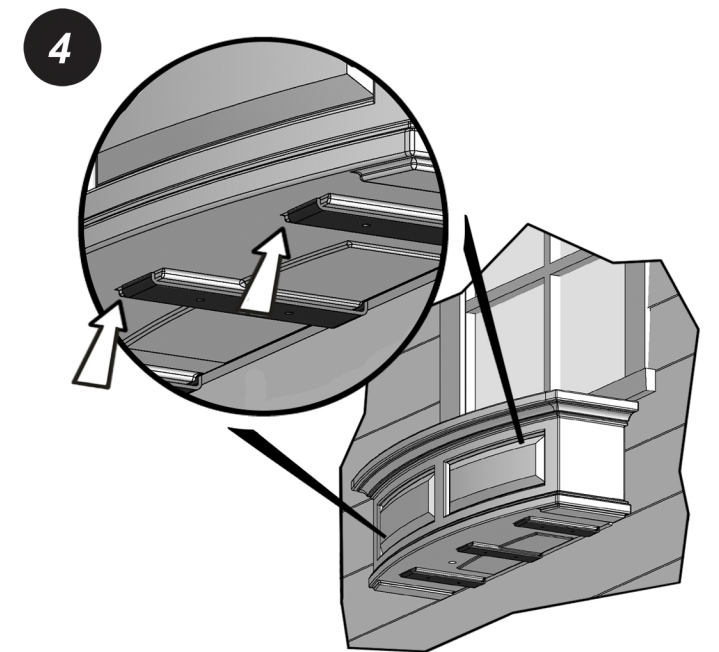

The molded feet on the bottom of the planter should sit flush on the wall mount brackets. Ensure the front edge of each footing is properly seated. If the front lip of the bracket isn't catching the foot on the planter remove the window box and bend the bracket upward slightly. Reattach the window box to test the fit.

Planting Instructions

MIS020 r4

General Planting Recommendations:

To maximize the efficiency of the sub-irrigation system and encourage healthy plant growth we recommend the following steps when setting up your planters:

- 1) Pour water directly into the planter to fill the reservoir. Allow the excess water to pour out the overflow hole. On the Nantucket window box the overflow is molded into the center of the soil basin and empties out through the bottom of the planter.
- 2) Next, add a few inches of lightweight filler to the bottom of the planter. This is optional but adding the lightweight filler will offer 3 benefits: it will reduce the amount of potting mix required, it encourages faster root growth down into the troughs, and it will help decrease the overall weight of the planter making it easier to move around. Some suggestions for lightweight fillers include lava rock, mulch, wood chips, or foam packing peanuts (don't use foam packing peanuts if you are growing edible plants).
- 3) Fill the planter with a potting mix to within an inch or two of the top. Regular garden soil is not recommended since it compacts too easy and doesn't allow for proper aeration or drainage.
- 4) Start planting and enjoy!

Sub-Irrigation System

The Nantucket window box includes a trough design creating a sub-irrigation water reservoir at the bottom of the planter. As noted in the steps above, the water reservoir can be filled prior to planting. Alternatively, the window box can be planted first and then with regular watering the reservoir will naturally fill up. Once the reservoir is full, capillary action allows water to soak upward keeping the soil and plant roots moist. To avoid oversaturation an overflow hole is molded through the floor of the window box allowing excess water to drain out from the bottom of the planter. Regular watering is required for the first few weeks giving the root system time to develop. Once the roots have grown down into the troughs the plants will be able to pull moisture from the reservoir creating a self watering effect. With this system you will find the potting mix stays moist longer than traditional containers planters. Please note that even with the reservoir and self watering effect, occasional watering is still needed.

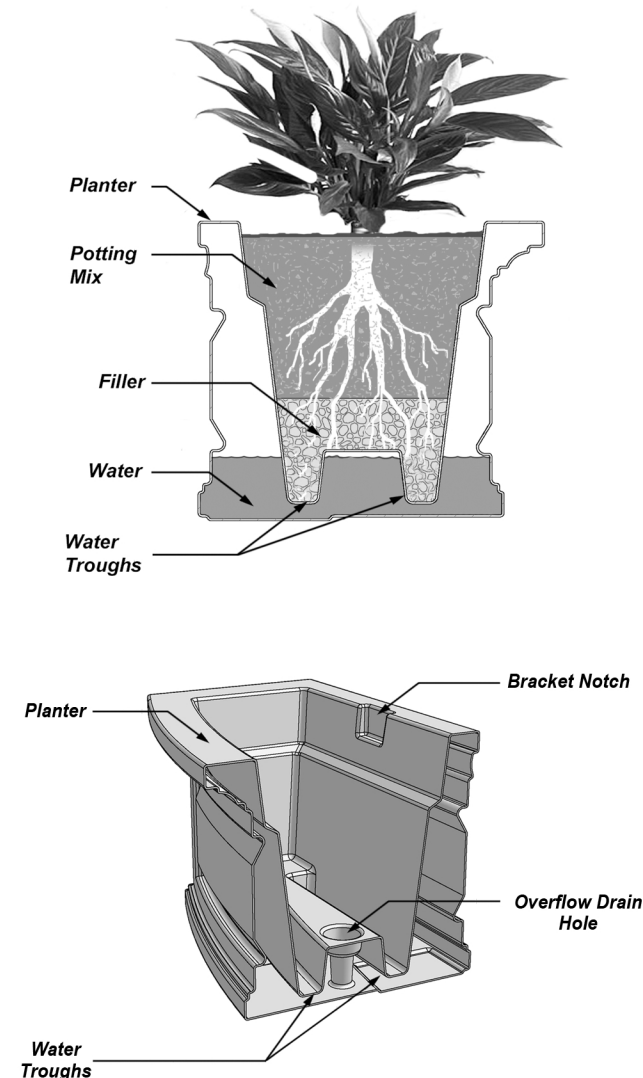

NOTE: Results may vary depending on the type of plant and depth of the root system. The above information is only suggested and Mayne holds no liability for the condition or growth of your plants.

Optional Fill Port Instructions

Plug Installation:

Mayne planters are molded with a double wall design that creates an internal water reservoir. To provide direct access to the reservoir we recommend drilling a 3/4 inch hole on the top or back side of the planter. To cover the hole we have included a rubber plug that can be easily removed to fill or drain the planter as needed.

Note: The rubber plug is provided as an added feature so the following steps are optional. Not intended for use on the bottom of the planter as the plug may not create a water tight seal.

