

CUTSHEET

Front View

Side View

Top View

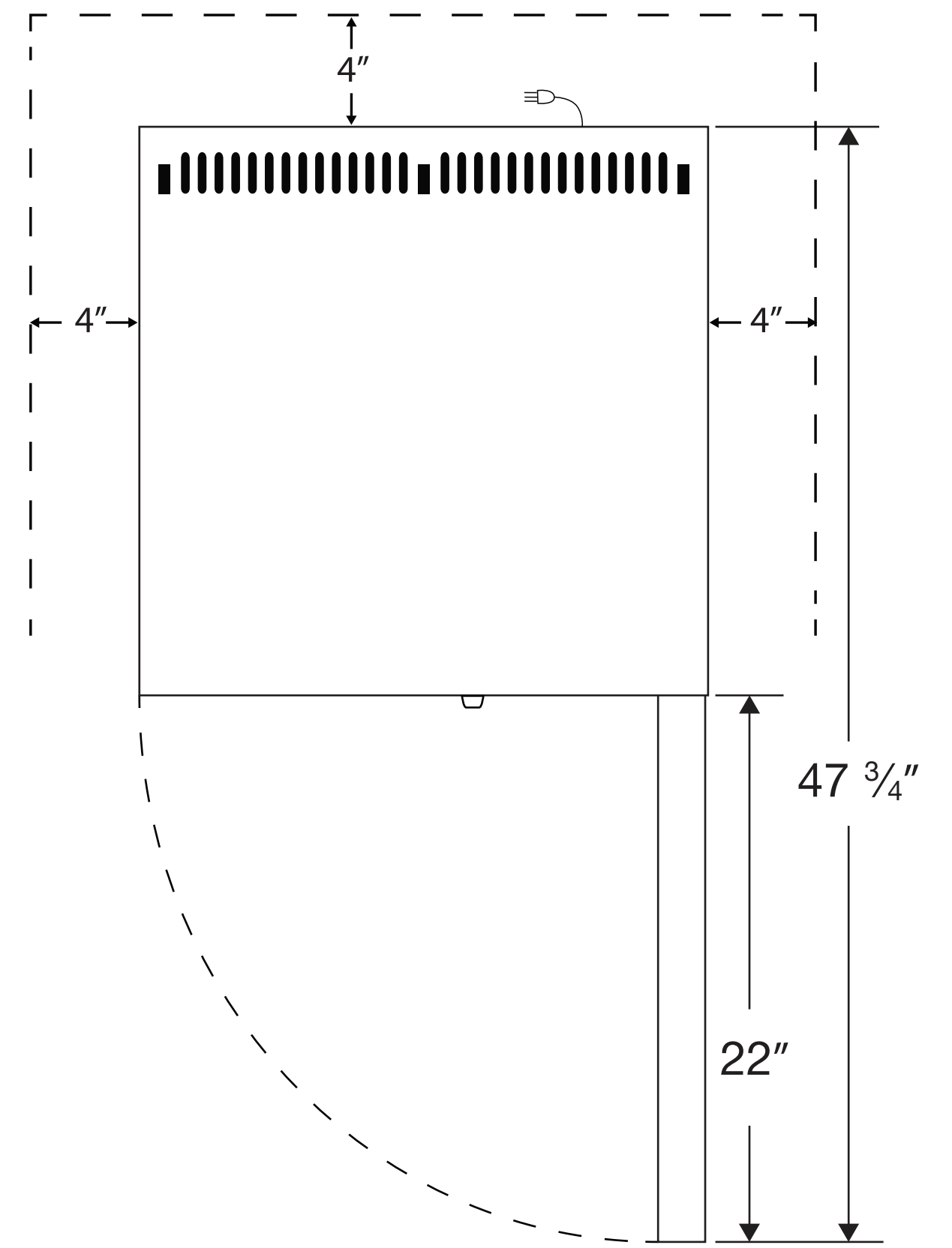
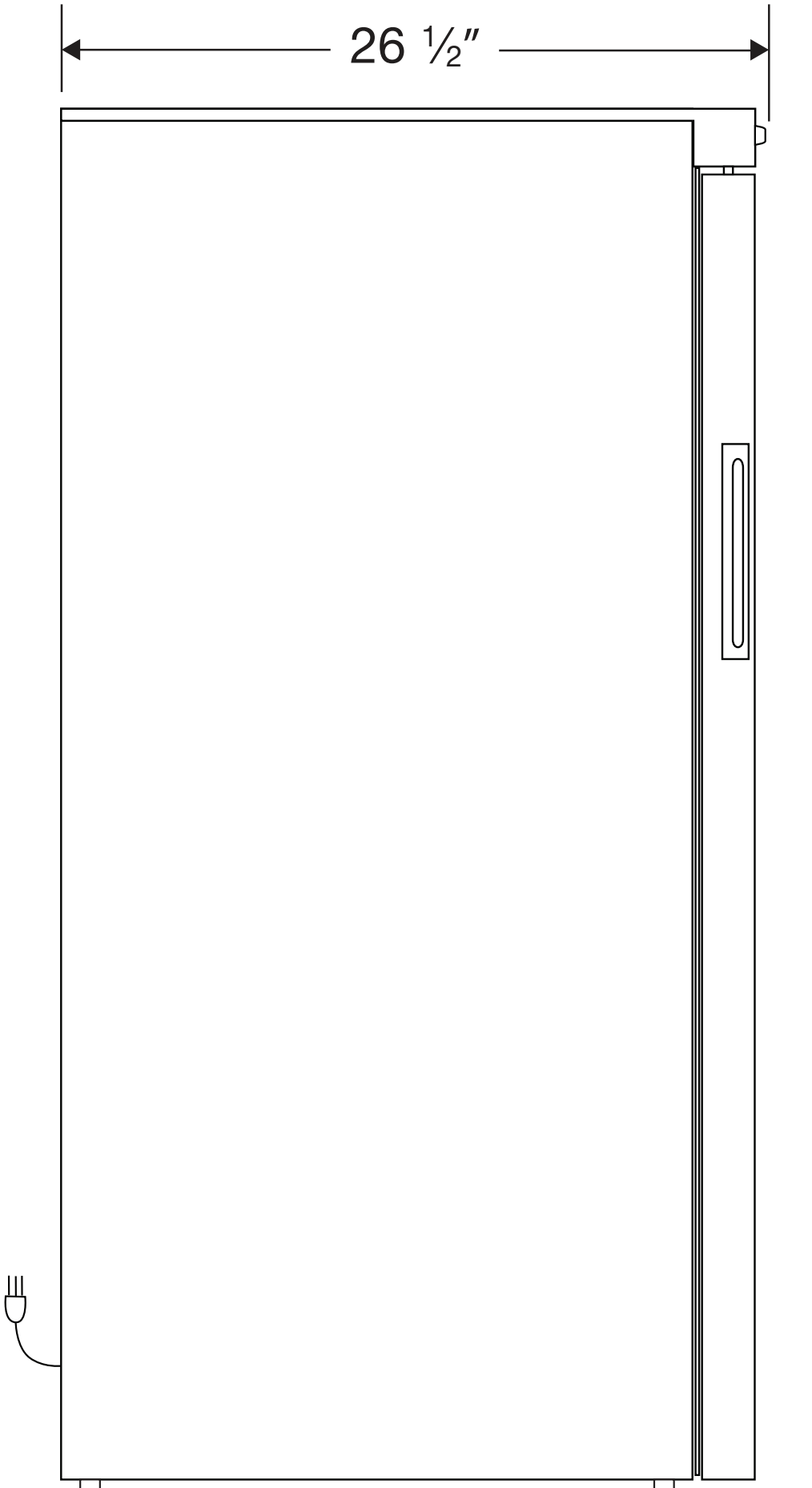
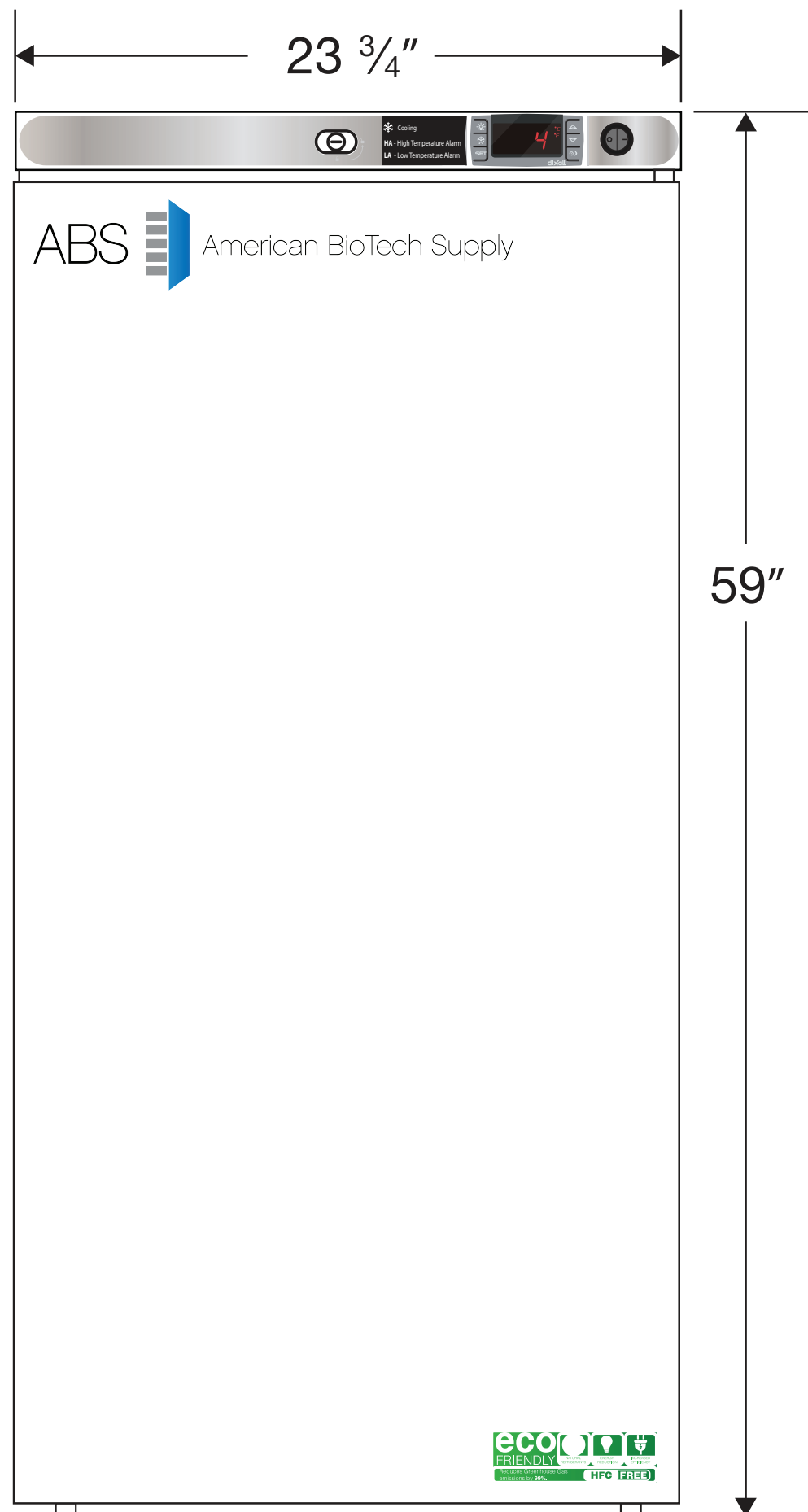

NOTE: Ventilation Requirements – Minimum 4" clearance on sides and back

115VAC/60Hz/1PH
NEMA-5-15P

Cu. Ft	Defrost	Door	Int Door	Shelves	W"	D"	H"	Refrigerant	H.P.	Amps	Weight
10.5	Cycle	1 Solid	0	6Adj +Footed Bottom	23 3/4	26 1/2	59	R600a	1/3	2.3	145 lbs.