

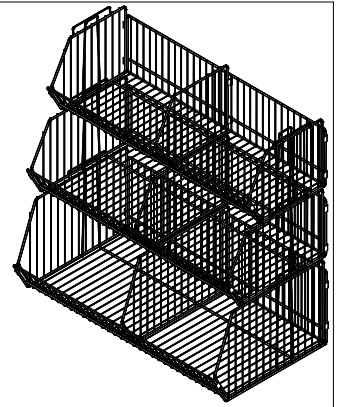

www.globalindustrial.com

1-800-645-2986

STACKABLE WIRE BIN SYSTEM ASSEMBLY INSTRUCTION



Stacking Wire Bin

A. Hook Side Panel onto back of Wire Bin (1) then hook onto front edge (3) while pushing front of Bin in (2).

B. Repeat for opposite side panel.

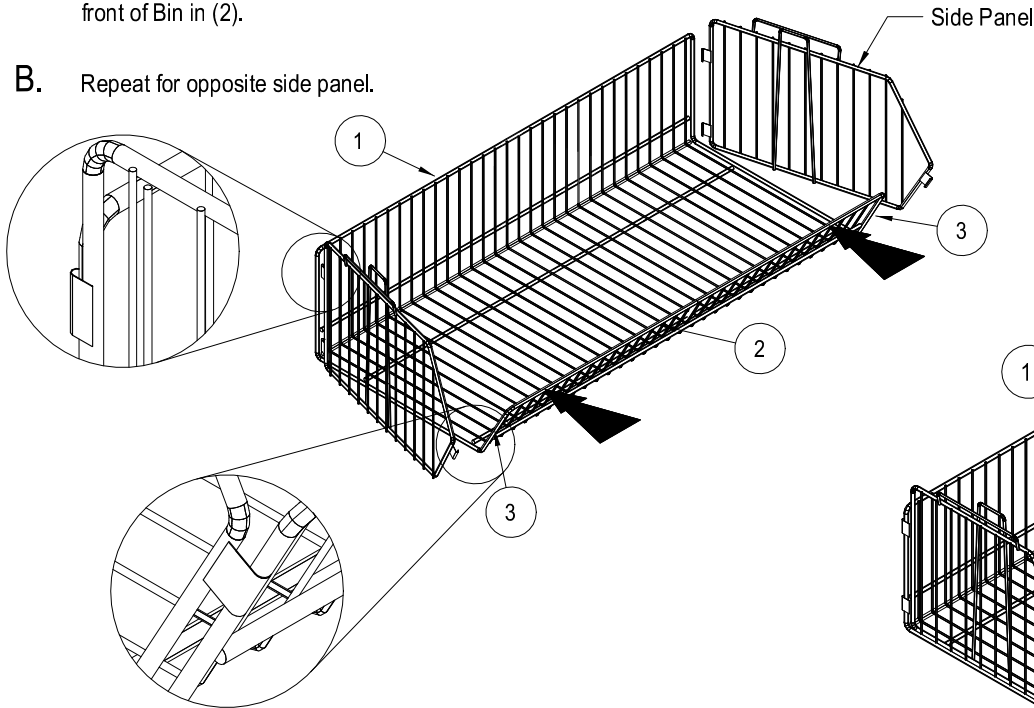

Optional Divider

Hook Optional Divider onto rear wire (1) then hook onto front wire (2).

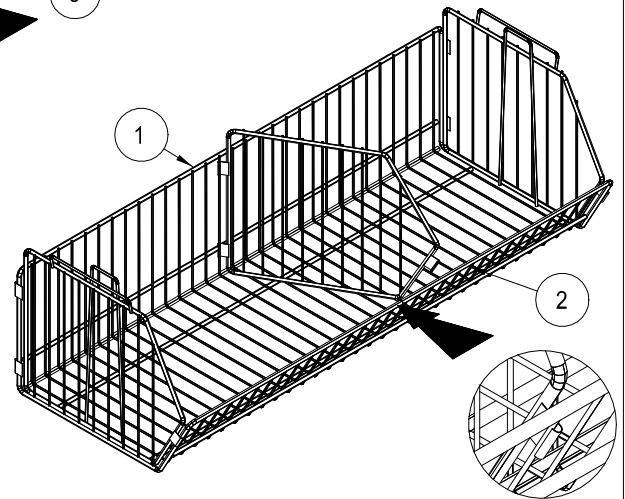

If Stacking Onto Another Unit.

Affix to one another with (2) U-Clamps, Square Neck Bolts and Wing-Nuts per side.

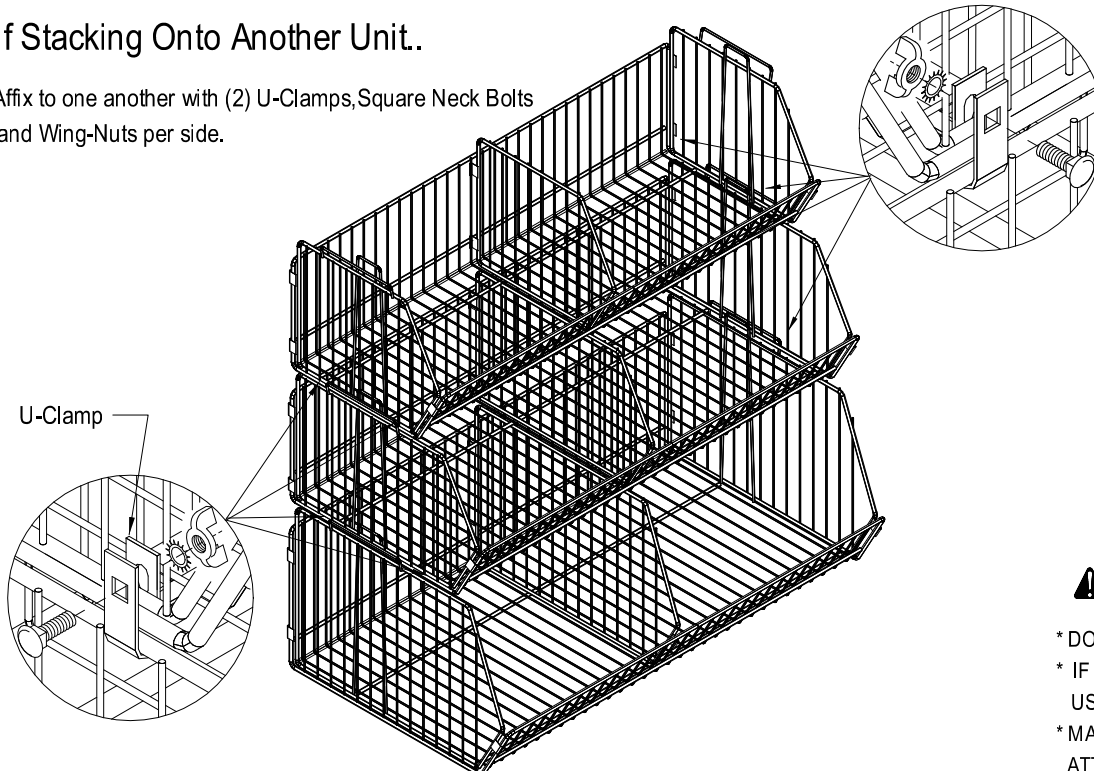

CAUTION

- * DO NOT OVERLOAD BINS
- * IF STACKED ON OPTIONAL MOBILE BASE, USE CAUTION WHEN MOVING.
- * MAKE CERTAIN SIDE PANELS ARE PROPERLY ATTACHED BEFORE STACKING.



www.globalindustrial.com

1-800-645-2986

MOBILE BASE ASSEMBLY INSTRUCTION

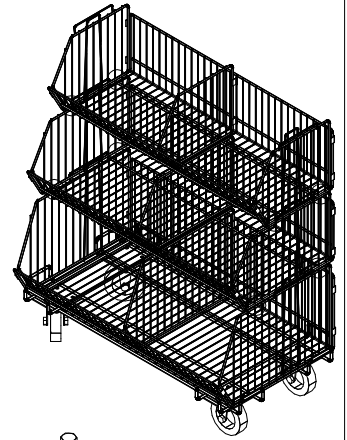

| CONTENTS | | |
|----------|------|---------------|
| REF. | QTY. | DESCRIPTION |
| 1 | 1 | MOBILE BASE |
| 2 | 2 | RIGID CASTER |
| 3 | 2 | SWIVEL CASTER |
| 4 | 2 | ANCHOR STRAP |
| H1 | 16 | |
| H2 | 16 | |

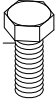

A. Attach Casters to Base with (3) Nuts & Bolts for each.

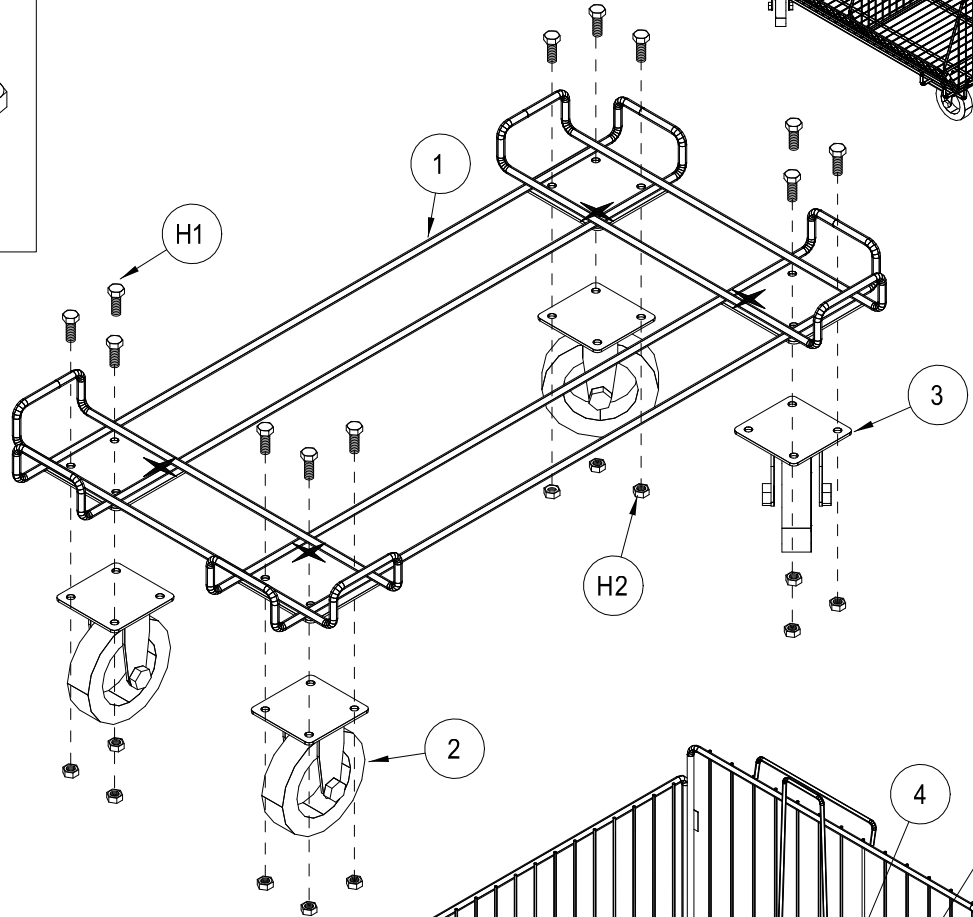

B. Place Bin firmly on Base and secure down with (2) Anchor Straps and remaining Nuts and Bolts.

