

Back-to-back cabinet installation

1. Make sure that the area where the cabinets and their bases will be installed is plumb and level.
2. Check the ventilation spacing between the back of the cabinets and ensure that the side panels have been properly installed. Align the cabinets to secure them back-to-back. The side panels must fully touch each other.
3. Install the metal plates on top of the cabinets as shown below.

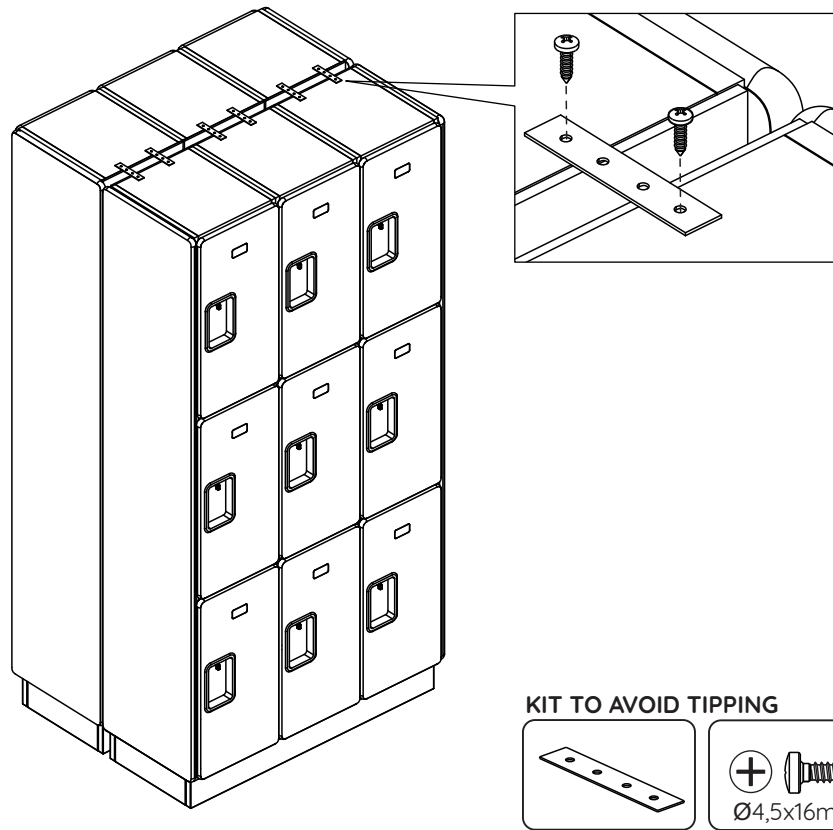

KIT TO AVOID TIPPING

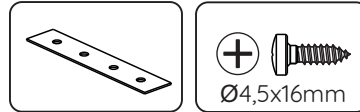

ASSEMBLY INSTRUCTIONS

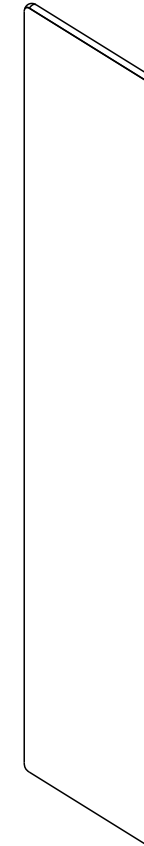

SIDE PANEL FOR WOOD LOCKER

Maintenance Tips

*To clean or remove stains, use a piece of flannel dampened with a mixture of alcohol and water. Avoid direct sunlight.

HARDWARE LIST

The hardware drawings are full-scale so their dimensions are the same as the actual hardware.

ID	IMAGE REFERENCE	# OF PIECES
A	 4,5 x 30mm	03

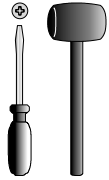

Mounting cabinets to the wall

1. Make sure that the area where the cabinets and their bases will be installed is plumb and level.
2. Check the ventilation spacing between the back of the cabinets and ensure that the side panels have been properly installed. Align the cabinets to secure them to the wall. The side panels must fully touch the wall.
3. Fold the metal plate and install it on top of the cabinets as shown below.

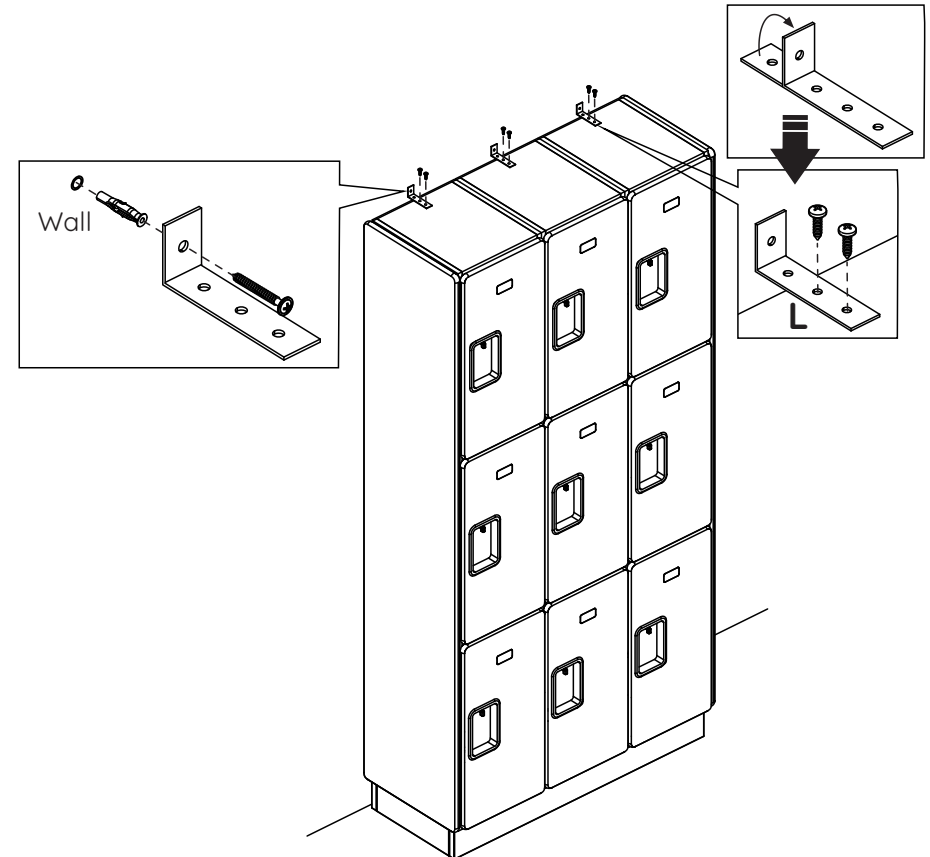

KIT TO AVOID TIPPING

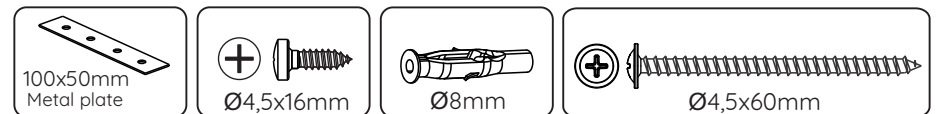

Metal base installation (add-on sold separately)

1. Make sure that area where the cabinets and their bases will be installed is plumb and level.
2. Position the metal base, aligning and centering it on the body of the previously joined cabinets.
3. After they are positioned, use the hardware that comes with the metal base component to join the parts on to the metal base to the cabinet base, as shown below.

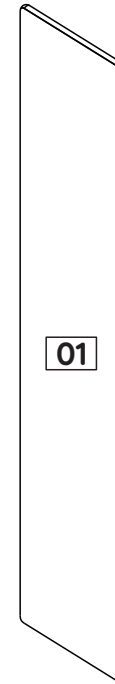
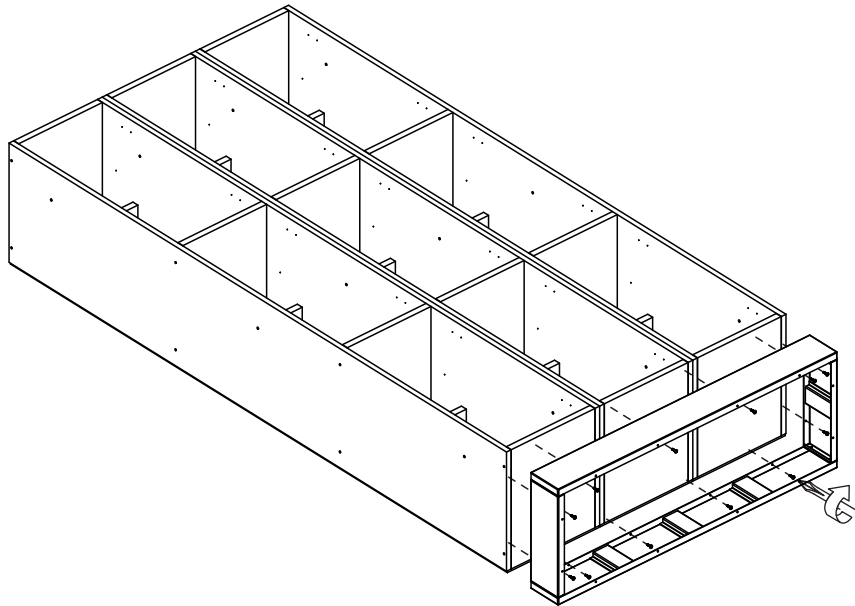
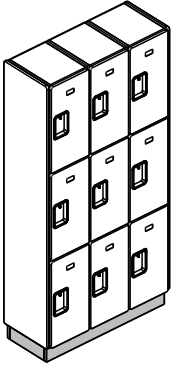

ID	Description	# Of Pieces	Dimension (mm)
01	Side	01	1828x381x18

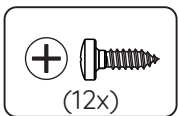

Side panel installation (add-on sold separately)

1. Make sure that the area where the cabinets and their bases will be installed is plumb and level.
2. Position the side panels so that they're aligned with the front of the cabinet body (not the door)
*****Check-01*****: The spacing created between the end of the panel and the back of the cabinet is for ventilation *****Check-02*****.
3. After they are positioned use the hardware that comes with the side panel to join them through the existing holes inside the cabinet wall as shown below.

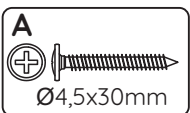
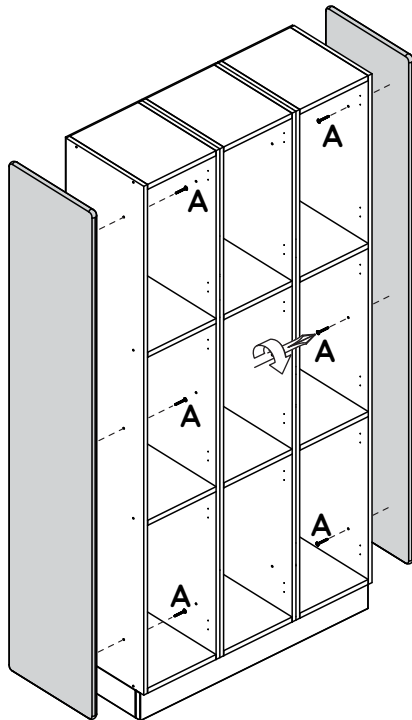
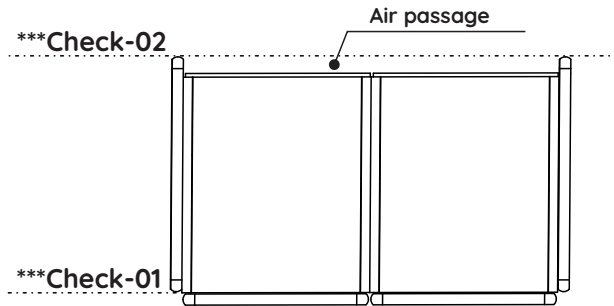

Corporate assembly

Join cabinets

1. Start by positioning the cabinets side by side, ensuring they are plumb and level.
2. After they are positioned, use hardware (H) to join them through the existing holes inside the cabinet wall, as shown below.

