



INNOVATIVE DESIGNS
FOR CREATIVE SPACES.

Solid Wood Art Table with Hardwood Top

Assembly Instructions

Tools Required for Assembly:

- $\frac{3}{8}$ " Ratchet with $\frac{1}{2}$ " Socket & 3" Extension
- Slotted Screwdriver

Included Hardware:

6 x $4\frac{1}{2}$ " Hex Bolts

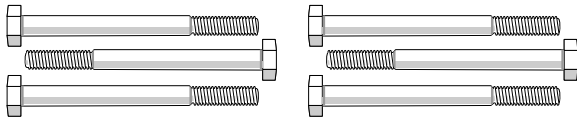

4 x 3" Hex Bolts

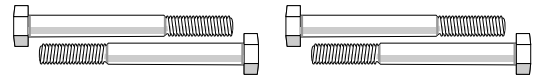

6 x Dowel Nuts



10 x Flat Washers



4 x Glides

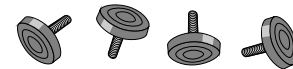

Wood Components:

2 x Top Supports

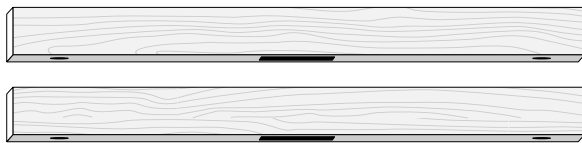

2 x Bottom Supports

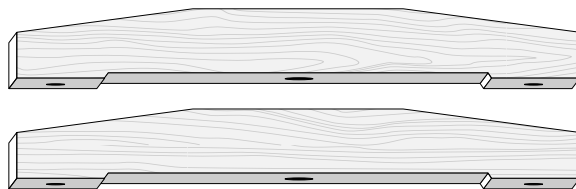

1 x Stretcher

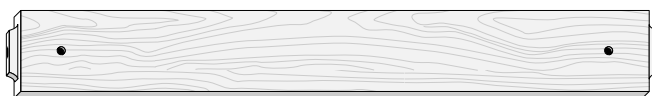

2 x Center Supports

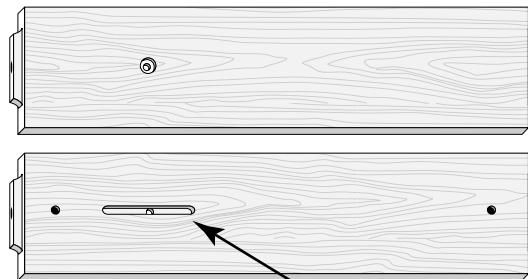

1 x Hardwood Top

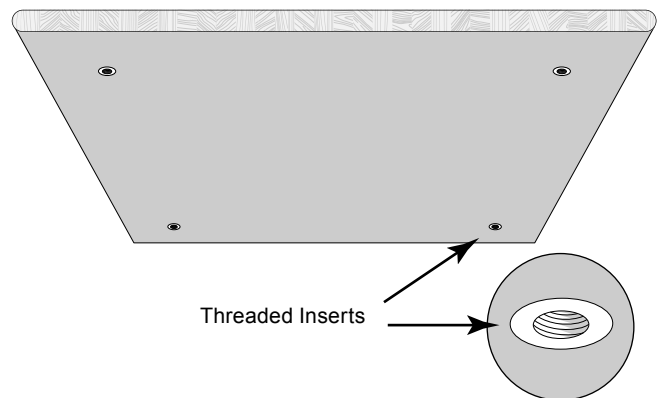

Solid Wood Art Table

Assembly

Tables: AT4260HM AT7272HM

Step 1. Leg Assembly:

A) Fit Top and Bottom Supports to the Center Support. Position the elongated slot toward the top.

Insert Dowel Nuts as shown. Use a screwdriver to align the Dowel Nuts, then thread 4½" Hex Bolts with Washers into the Dowel Nuts and tighten firmly.

Repeat for the second leg assembly.

B) Install Glides in the Bottom Supports.

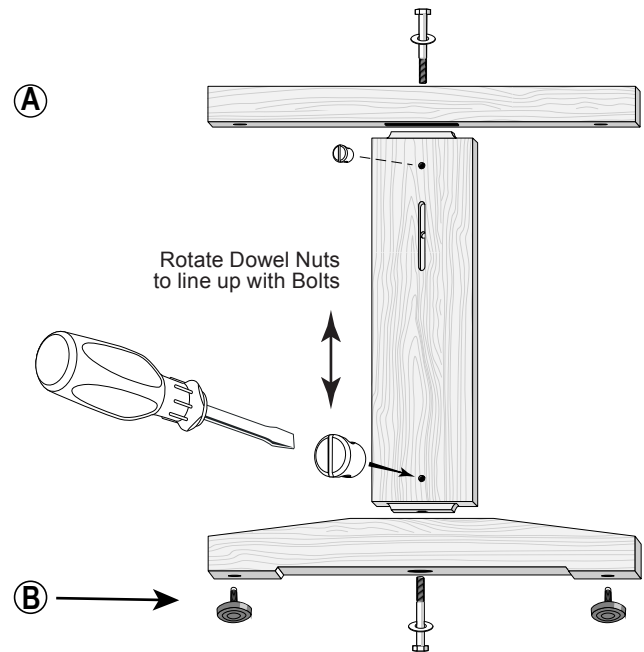

Step 2. Stretcher Assembly:

C) Fit Stretcher into the elongated slots in Center Supports. Insert Dowel Nuts and 4½" Bolts With Washers as shown. Do not fully tighten yet.

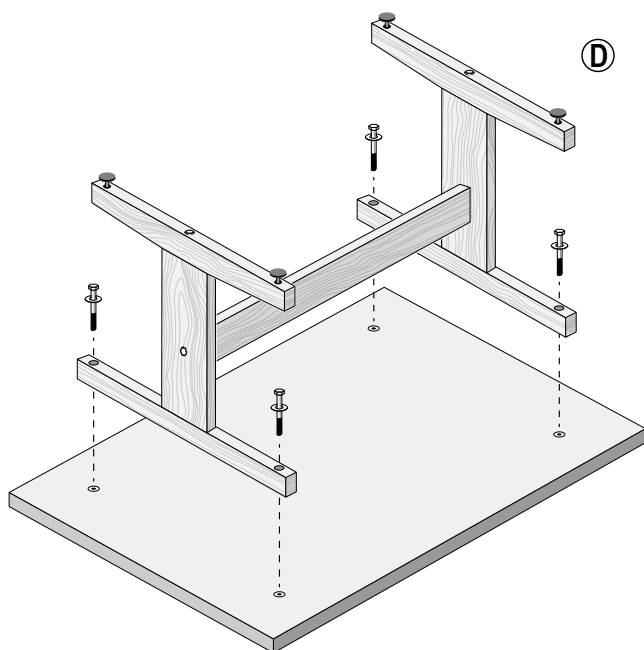
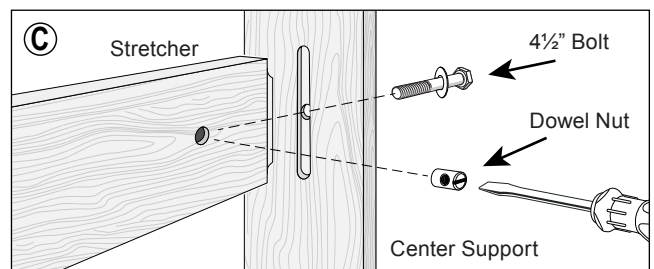

Step 3. Table Top Assembly:

D) Lay Table Top upside-down on a clean surface. Position leg assembly by aligning bolt holes in the Top Support with the Threaded Inserts in Table Top.

Install 3" Hex Bolts and Washers. Fasten loosely.

When all four bolts are installed, fully tighten the bolts holding the Table Top, then the bolts attaching the Stretcher to the Leg Assemblies.

With a helper, turn the table upright and enjoy your new Art Table!