

1. SPECIFICATIONS:

- | | |
|-----------------------------|--|
| • Dimensions (W x H x D) | 122 mm x 270 mm x 106 mm (4.8" x 10.63" x 4.17") |
| • Soap Tank Capacity | 800 ml (27.1 fl oz) |
| • Adaptor Required | Input : 100~240Vac, output : DC 6V |
| • Battery Type Required | Alkaline (1.5V) AA size, Qty 4 |
| • Battery Life Estimated | Liquid type : 25,000 cycles or 1 year |
| | Foam type : 25,000 cycles or 1 year |
| | Disinfectant spray : 16,000 cycles or 1 year |
| • Soap Pump Life Estimated | 100,000 cycles |
| • Detection Range Automatic | Auto-detecting. Default setting: 75 mm (2.95") ± 15 mm (0.59") |
| • Room Temperature | 5~40 °C (41~104 °F) |
| • Dispensing Volume | Liquid type : 0.8~1.1 ml (0.027~0.037 fl oz) |
| | Foam type : 0.7~1.0 ml (0.023~0.033 fl oz) |
| | Disinfectant spray : 0.8~1.1 ml (0.027~0.037 fl oz) |
| • Unit Net Weight empty | 1 kg (2.2 lbs) |

2. RECOMMENDED INSTALLATION:

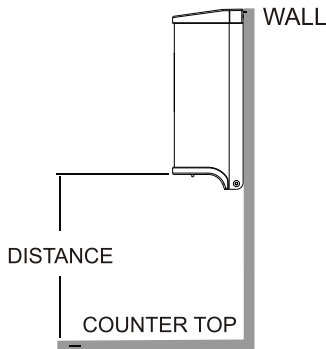

DISTANCE (MINIMUM TYPICAL)
 NORMAL COUNTER TOP
 At least 7-7/8" (200 mm)

3.1 INSTALLATION STEPS, Tile or Dry Wall

1. Tape the installation template at the appropriate location on the mounting surface.
2. Drill four (4) holes at marked locations 5/16" diameter (Ø8).
3. Insert four (4) plastic anchors (supplied) into drilled holes; remove template (fig. 1).
4. Insert two (2) screws (supplied) into top plastic anchors and leave 1/8" (3) space from the wall under head (fig. 2 and fig. 3) for hanging dispenser.
5. Hang the dispenser on the two (2) screws through the keyhole slots at backplate top.
6. Use key to unlock and pull forward the housing cover (fig. 4).
7. Remove soap reservoir and lock dispenser to wall with remaining two (2) screws (supplied) through the holes at backplate bottom. Tighten all screws (fig. 5).

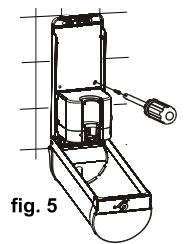
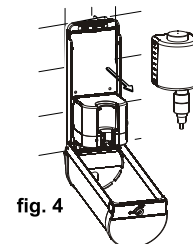
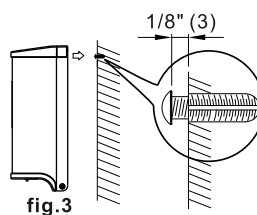
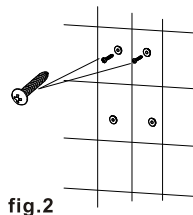
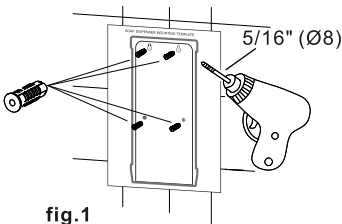

ATTENTION!

✗

✓

Take out the soap tank before refilling to prevent spilling onto the dispenser mechanism.

Use the appropriate soap with each type of soap pump.

WARNING: Wrong type of soap may damage the soap pump.

3.2 INSTALLATION STEPS, Adhesive on Mirror

1. Clean mounting surface in area to be installed with isopropyl alcohol.
2. Mark outline of dispenser on mirror with masking tape.
3. Remove paper liners from self-adhesive pads on dispenser backplate.
4. Place unit on mounting surface with even steady pressure and hold for 1 minute.
5. Let tape cure for 10 hours prior to filling dispenser with soap for use.

4.1 OPERATION INSTRUCTIONS(AC)

1. Open housing with included security key previously retained.
2. Take the AC Adaptor plug through the hole of baseplate (fig. 1) and connect the DC jack (fig. 2)
3. Plug it in.
4. Obtain a disposable soap cartridge (800ml) or remove, clean out and refill the included reusable soap reservoir with the correct viscosity liquid soap (ensure that soap container cover is closed and air vent hole is open and nozzle is not clogged and that soap container is clean (no spill-over) and not leaking) and install either in the dispenser.
5. Close the housing cover and lock it with the included security key previously retained.
6. Observe that the LED light is blue and then flashes four (4) times. This indicates that the environment has been detected. If there is no object under the dispenser, the default sensing distance is 8-10 cm. If there is an object (such as a basin or counter) under the dispenser, the sensor will detect the installation height and environment light to set a suitable sensing distance automatically.
7. Trigger the sensor with hands or a towel to check proper soap dispensing cycle .

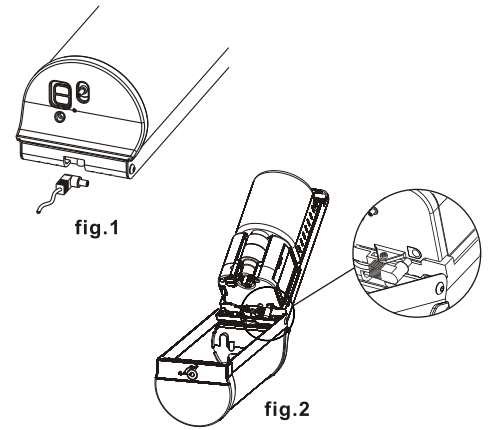

4.2 OPERATION INSTRUCTIONS(DC)

1. Open housing with included security key previously retained.
2. Open cover on battery compartment, remove battery box and unplug cable; install four (4) new Alkaline Type AA 1.5V batteries with correct polarity (note the +/- indication) to obtain 6V DC \pm 10% at the plug.
3. Reinstall battery box and close compartment cover.
4. Obtain a disposable soap cartridge (800ml) or remove, clean out and refill the included reusable soap reservoir with foam soap (ensure that soap container cover is closed and air vent hole is open and nozzle is not clogged and that soap container is clean (no spill-over) and not leaking) and install either in the dispenser.
5. Close the housing cover and lock it with the included security key previously retained.
6. Observe that the LED light is blue and then flashes four (4) times. This indicates that the environment has been detected. If there is no object under the dispenser, the default sensing distance is 8-10 cm. If there is an object (such as a basin or counter) under the dispenser, the sensor will detect the installation height and environment light to set a suitable sensing distance automatically.
7. Trigger the sensor with hands or a towel to check proper soap dispensing cycle .

7. BATTERY LOW INDICATION(DC)

With housing cover open and soap reservoir removed (see Instructions) perform the following diagnostic test:

1. Press and push up the cover safety interlock switch (blue stem) on bottom to click and hold it.
2. Observe that the LED is lit blue and then flashes four (4) times indicating proper operation "stand-by" condition and battery charge level.
3. If LED continues to flash blue the indication is positive to replace the batteries.

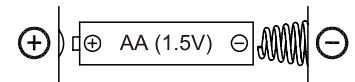

Caution : Batteries installed with incorrect polarity may cause malfunction.

5. IMPORTANT NOTICE(DC)

1. Ensure no bright source is aimed or reflected at the sensor from below.
2. Use brand new foam soap only and clean the soap container properly before each re-fill. Deposits of old soap will lead to malfunction and jamming.
3. Do not dilute foam soap unless concentrate and do not use soap containing abrasive. Observe indicated viscosity factor of foam soap.
4. Do not immerse the soap dispenser in water or clean it under running water. This will lead to short circuit.
5. Should the dispenser be out of order and batteries have been replaced, do not attempt any repair work. Call your dealer for professional assistance.

8. IMPORTANT

Three different types of soap pump can be installed in the same dispenser. When changing to a different type of soap pump, it's better to use a separate soap tank for each type of soap pump. If the same soap tank is to be used for different types of soap pump, clean the soap tank thoroughly to ensure no residual soap from previous use remains in the tank. The soap pump may be jammed when the wrong type of soap is used.

6. Diagram

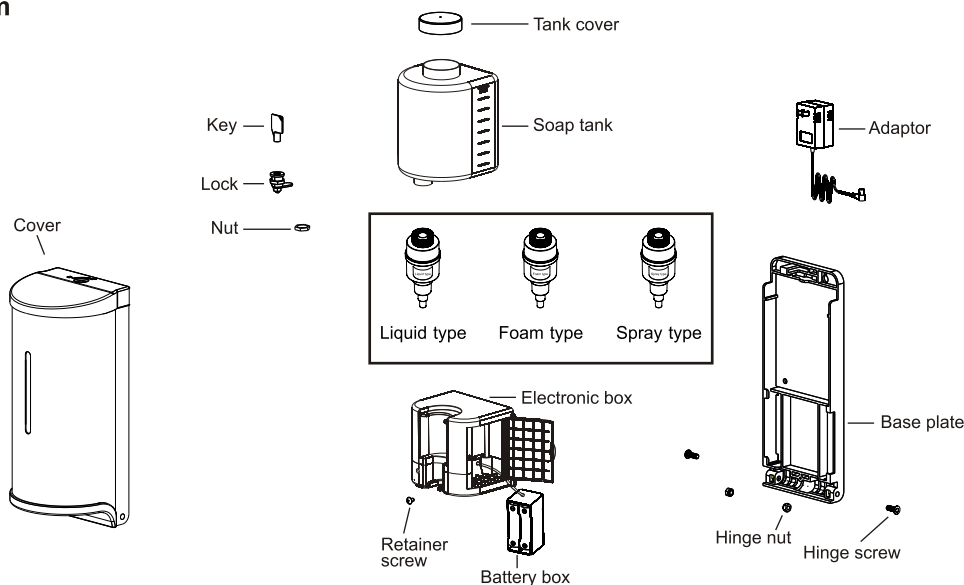

kit

- | | |
|---------------------------|--|
| 1. Key x 1 | |
| 2. Plastic Anchor x 4 | |
| 3. Mounting Screw x 4 | |
| 4. Mounting Template x 1 | |
| 5. Self-adhesive Tape x 3 | |