

LIFT AND TILT SCISSOR TABLE - EHLTT-3648-3-47

APPROX WEIGHT: 1056.03 lbs.
DOES NOT INCLUDE WEIGHT OF POWER OR PACKAGING!!!

*** ANY ADDITIONS, DELETIONS, OR OMISSIONS MUST BE CORRECTED ON THIS DRAWING AS THIS DRAWING WILL BE CONSIDERED ALL INCLUSIVE ***

ALL GRAPHICS PROVIDED ARE FOR REFERENCE ONLY. IF CERTAIN DIMENSIONS ARE CRITICAL PLEASE VERIFY THOSE DIMENSIONS WITH YOUR SALESPERSON

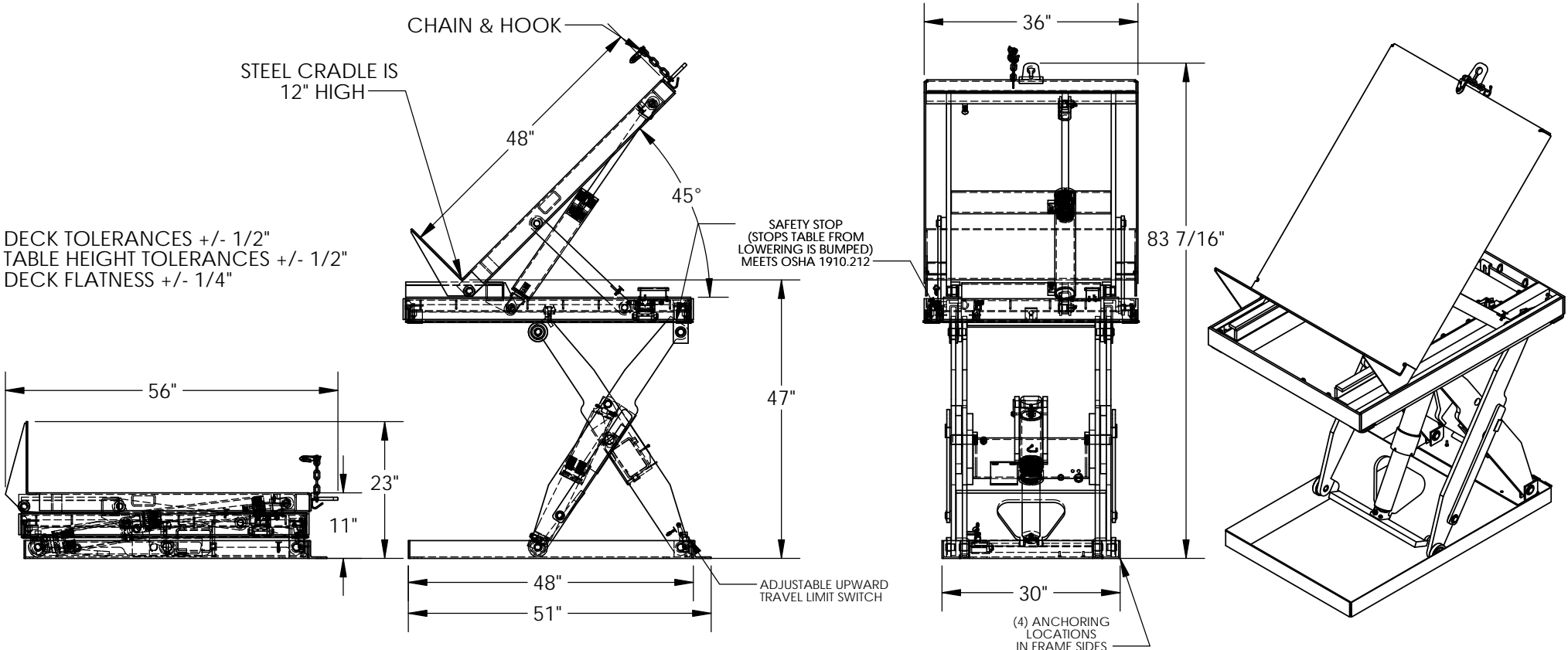

STANDARD FEATURES

- MODEL NUMBER IS EHLTT-3648-3-47
- MAX CAPACITY IS 3,000 LBS
- PLATFORM WIDTH IS 36"
- FRAME WIDTH IS 30"
- OVERALL LENGTH IS 56"
- PLATFORM LENGTH IS 48"
- PLATFORM RAISED HEIGHT IS 47"
- PLATFORM LOWERED HEIGHT IS 11"
- OVERALL HEIGHT IS 83 7/16"
- PLATFORM TILTS ON THE END OF THE LEG ASSEMBLY
- PLATFORM TILTING STYLE IS A SLIDE TILT
- Ø1/4" x 60" CHAIN AND HOOK (NOT DRAWN TO SCALE)
- MAXIMUM TILT ANGLE IS 45°

SPECIAL FEATURES

NONE

PLEASE CIRCLE SPECIFICATIONS:

POWER	AC	DC (12V)	AIR/OIL
MOTOR VOLTAGE	115	208	230 460
DEDICATED CIRCUIT REQUIRED 60Hz			
MOTOR PHASE	SINGLE	THREE	
CONTROL	HAND	FOOT	

FOR INTERNAL USE ONLY PROJECT SIGN OFF	
SALES	
ENG.	
FAB.	
POWER	

APPROVAL

I, THE UNDERSIGNED, AGREE THAT THE PRODUCT AS REPRESENTED SATISFIES DESIGN AND DIMENSION REQUIREMENTS. I ALSO ACKNOWLEDGE MY DUTY TO CONFIRM PRODUCT AND INSTALLATION COMPLIANCE WITH ALL APPLICABLE FEDERAL, STATE AND LOCAL REGULATIONS AND STANDARDS.

ANY MODIFIED UNITS ARE NON-RETURNABLE

[] As drawn [] As marked

Signed: _____ Date: _____

Printed Name: _____

LEAD TIME WILL START UPON RECEIPT OF SIGNED APPROVAL DRAWING

DISTRIBUTOR'S NAME:		P.O.#
VESTIL MANUFACTURING		X
DRAWN BY: BCN		W.O.#
DATE: 2/3/2017		X
REFERENCE: X	SCALE: 1:25	SALES: X
QUOTED LEAD TIME: X	QUOTE #	FILE NAME:
	X	02-007-311-001