



www.globalindustrial.com

1-800-645-2986

BOLTLESS EXPANDABLE STORAGE RACK

ASSEMBLY INSTRUCTION

WIRE DECK
SHELVING UNIT

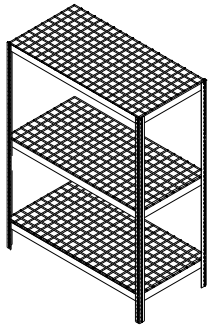

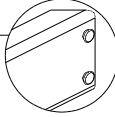
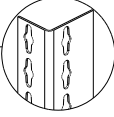
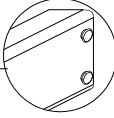
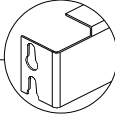
CONTENTS	
REF.	DESCRIPTION
1	DOUBLE RIVET BEAM (LONG) 
2	UPRIGHT 
3	DOUBLE RIVET BEAM (SHORT) 
4	DECK SUPPORT 

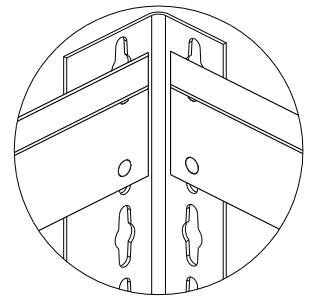
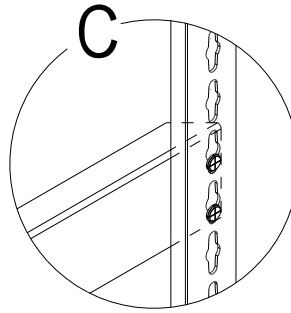
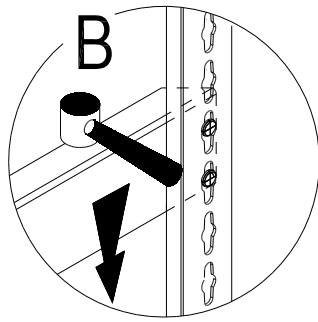
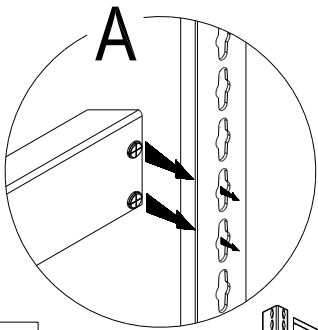

CORNER DETAIL

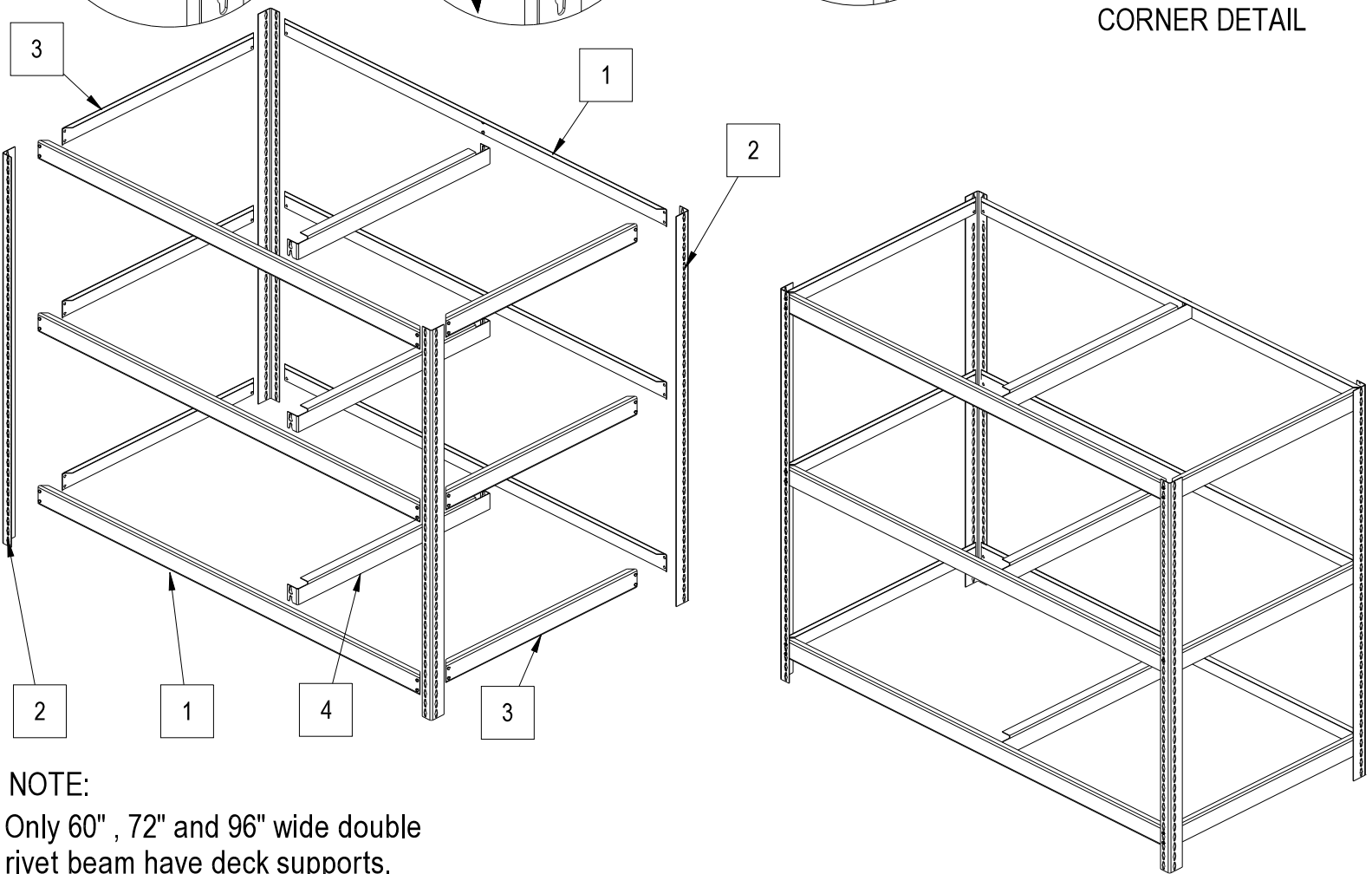

NOTE:
Only 60" , 72" and 96" wide double rivet beam have deck supports.