

LW36

Lab Workstation

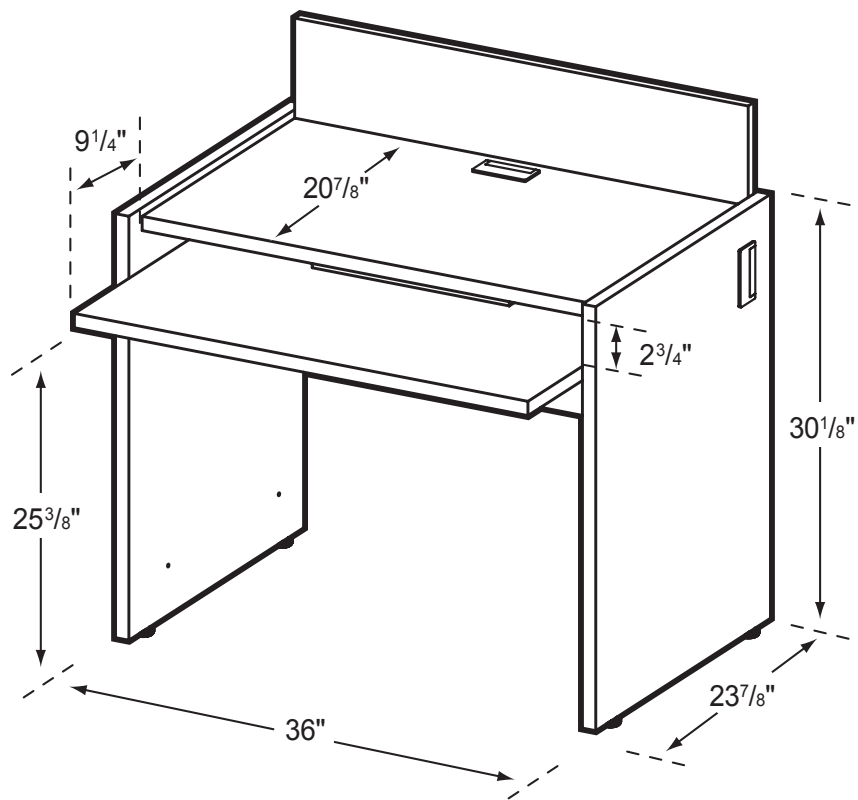

Product Specs

- 1" thermal fused laminate sides
- 3/4" thermal fused laminate top, keyboard and back
- Cam and post construction
- Matched edge banding
- Fixed key board shelf
- Three - 2"x 4" grommets with covers
- Wire management tray
- Adjustable leveling glides

0208