

MVP GROUP CORPORATION  
[www.mvpgroupcorp.com](http://www.mvpgroupcorp.com)





5659 ROYALMOUNT AVE.  
MONTREAL, QC H4P2P9  
TEL: 514-737-9701 1-888-275-4538  
FAX: 514-342-3854 1-877-453-8832

12000 BISCAYNE BLVD. STE 108  
MIAMI, FL 33181  
TEL: 786-600-4687 1-844-218-8477  
FAX: 786-661-4100

[sales@mvpgroupcorp.com](mailto:sales@mvpgroupcorp.com) [www.mvpgroupcorp.com](http://www.mvpgroupcorp.com)

This page has been left blank intentionally.

# INDEX

<b>1 General information</b>	<b>5</b>
1.1 Case description	5
<b>2 Getting started with your KGH series</b>	<b>55</b>
2.1 Location	55
2.2 Uncrating	55
2.2.1 Front and sides assemblies	57
2.3 Check for damage	57
2.4 Control panel and main features	58
2.5 Check serial, model numbers and requested options	61
2.6 Warning/Caution labels	63
2.7 Check your electrical installation	68
2.8 Electrical, drain and refrigeration connections (remotes only)	68
2.9 Joining	69
2.10 Plugging and start	75
<b>3 Refrigeration</b>	<b>78</b>
3.1 Self contained refrigeration equipment and defrost	78
3.2 Refrigeration loads (remotes only)	81
<b>4 Electrical</b>	<b>82</b>
4.1 Electrical specifications data	82
4.2 Electrical service receptacles (optional)	84
4.3 Electrical diagrams	85
4.5 Electronic controller	99
<b>5 Maintenance</b>	<b>102</b>
5.1 Exterior cleaning	102
5.2 Interior cleaning	103
5.3 Shelf removing/adjustment	103
5.4 Front doors handling	104
5.4.1 Doors positions	104
5.5 Door installation	104
5.5 Light substitution	109
5.6 Panels and protection grill removal	110
5.7 Condensator cleaning	111
5.8 Evaporator cleaning	111
5.9 Evap Pan cleaning	112
5.11 Drain inspection	113
5.12 Sliding condensing unit	114
5.13 Electrical shutter breakdown	114
5.13.1 Manual operation	114
5.13.2 Setting position	115
<b>6 Troubleshooting/ Service</b>	<b>116</b>
6.1 Troubleshooting	116
6.1 Service	117
<b>7 Warranty</b>	<b>119</b>
<b>8 Notes</b>	<b>120</b>

This page has been left blank intentionally.

This page has been left blank intentionally.

This page has been left blank intentionally.





## KGH SERIES

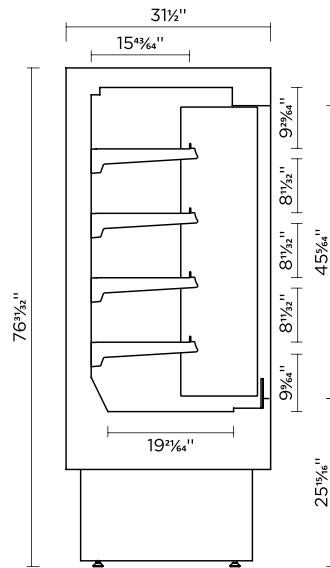

KGH-OF-S(R)



KGH-OF-S(R)

## 7 Warranty

12 month warranty for all parts from the invoice date. A new part will be provided free of charge. Defective part must be returned to the manufacturer.

Warranty claims: All claims must include model number, serial number, date of purchase, date of installation and additional information about the supposed defect.

All service work must be authorized by MVP group.

MVP group reserves the right to select the service company.

Loss of food or other damages caused by faulty equipment aren't covered by this warranty.

Warranty does not cover damage when uncrating.

Work made necessary, by lack of maintenance or cleaning are not covered by this warranty.

Warranty does not cover damage or malfunction result of improper use or installation.

Warranty does not cover negligence, misuse and operation on wrong voltage.

Warranty does not apply if the serial number is altered or defaced.

Warranty does not cover any glass break.

Warranty doesn't cover any act of negligence.

Warranty doesn't cover defects on units with unoriginal parts.

Warranty doesn't cover acts of repair or maintenance by non fully authorized personnel.



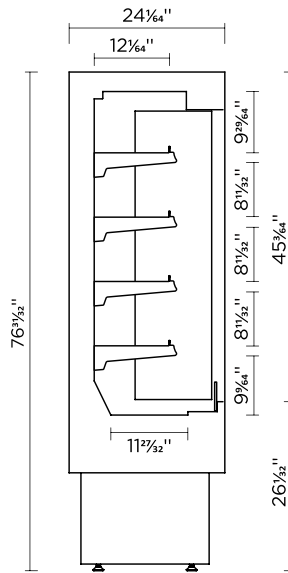

KGH-OS-S(R)



KGH-OS-S(R)

Equipment runs constantly:

- Condenser dirty.
- Condenser fan malfunction.
- Temperature and relative humidity too high.

Starting relay burns out:

- Low voltage.
- High voltage.
- Compressor short cycles.
- Incorrect running capacitor.
- Incorrect relay.

Head pressure too high:

- Unit overcharged.
- Air or other non condensable gases in the system.
- Clogged condenser.
- Defective condenser fan motor.
- Unit location too hot.
- Restriction in charge line.



Head pressure too low:

- Insufficient refrigerant charge.
- Leak in the system.
- Cold location.

Noisy unit:

- Compressor oil charge low.
- Fan blade causing vibrations.
- Tube rattle.
- Loose parts.
- Case not leveled.

6.2 Service

-  This operation must be performed by a qualified technician.
-  For spare parts, contact your distributor.

## 6 Troubleshooting/Service

### 6.1 Troubleshooting

 Service must be performed by a qualified technician.

#### Doors not closing:

- Check for leveled floor.
- Check for obstruction.
- Remove doors and check the bearings.

#### Lights not working:

- Check light switch position.
- Check light connections.

#### Warm case temperature:

- Check for air return grille obstruction.
- Check for air drafts.
- Check store temperature.
- Check for condenser obstruction and cleaning.
- Check for frozen evaporator.
- Check set point.
- Display area is over filled.

#### Fans not working:

- Check electrical connections.
- Check for any debris.

#### Case not aligning:

- Check for leveled floor.
- Check instructions for joining.

#### Display not working:

- Check main power switch position..
- Check electrical connections.

#### Compressor not starting:

- Disconnect switch open.
- Blown fuse.
- Overload protective tripped.
- Low charge of refrigerant.
- Relay defective.

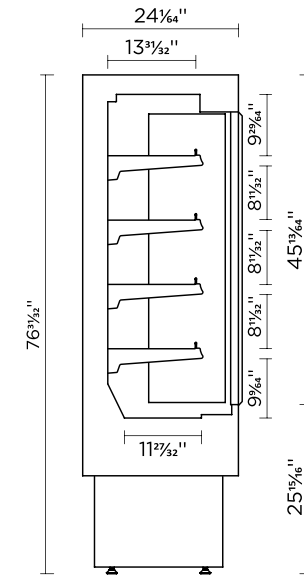

KGH-DS-S(R)



KGH-DS-S(R)

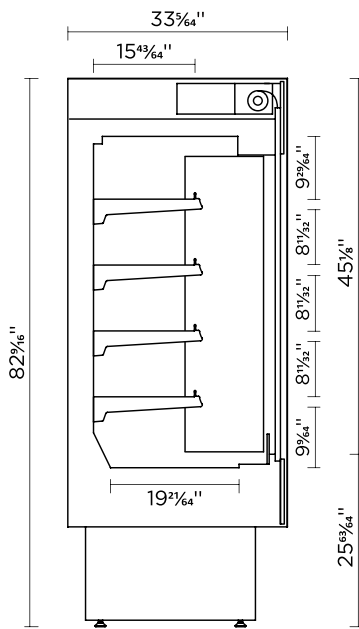

KGH-ES-S(R)



KGH-ES-S(R)

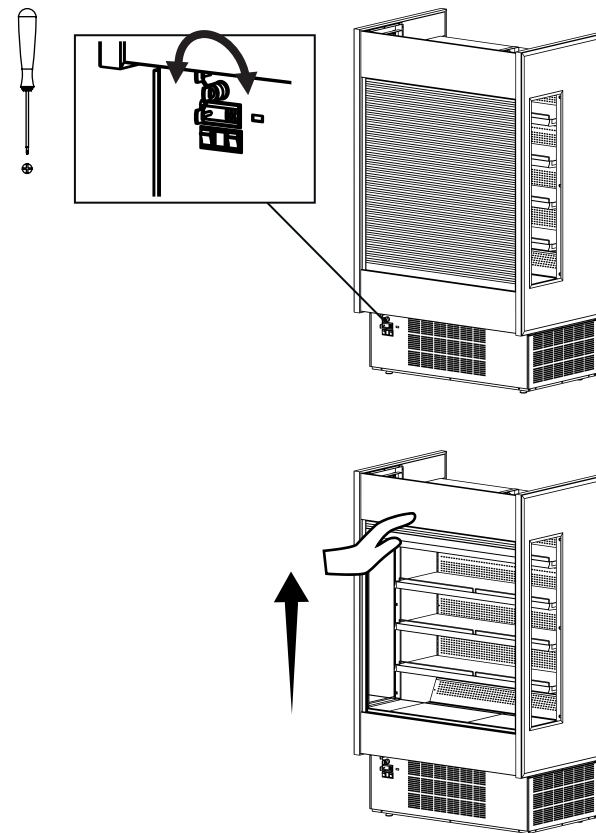

### 5.13.2. Setting position



All operations must be performed by a qualified technician.

For more information go to [www.somfy.com](http://www.somfy.com).

## 5.12 Sliding condensing unit

- ⚠ All operations must be done with the unit disconnected.
- ⚠ All operations must be performed by a qualified technician.

To replace components in the condensing unit you can slide it to have access.

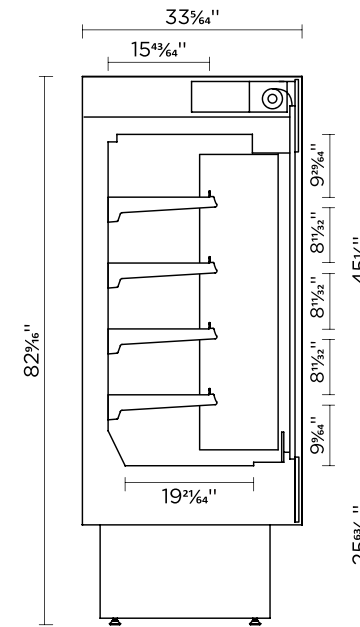
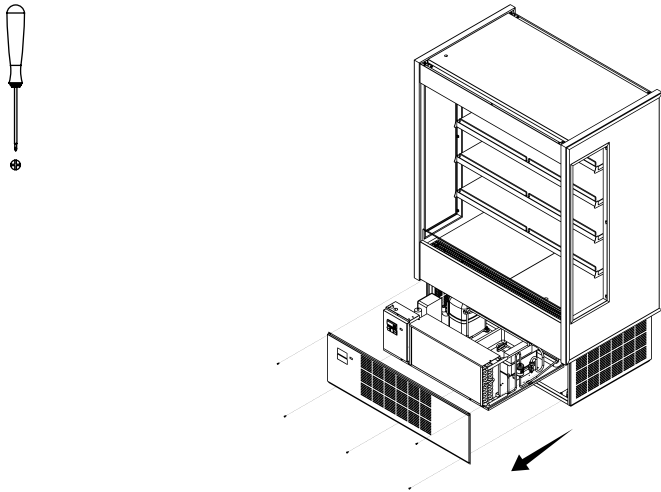

KGH-MS-S(R)

## 5.13 Electrical shutter breakdown

### 5.13.1. Manual operation



- ⚠ All operations must be performed by a qualified technician.
- ⚠ Manual opening of the shutter only when no power situation.
- ⚠ Make sure to insert key in the Wright place.

For more information go to [www.somfy.com](http://www.somfy.com).



KGH-MS-S(R)

## Implantation

-  Drain outlet
-  Electrical board
-  Refrigeration piping

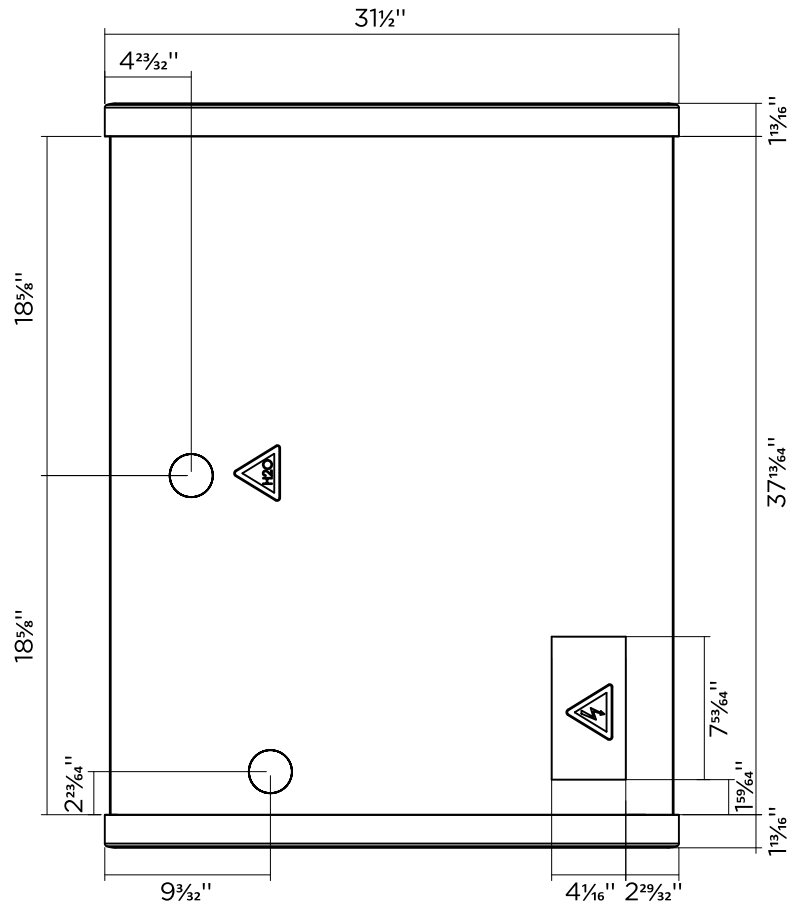

↑ Front

KGH-OF-40-S

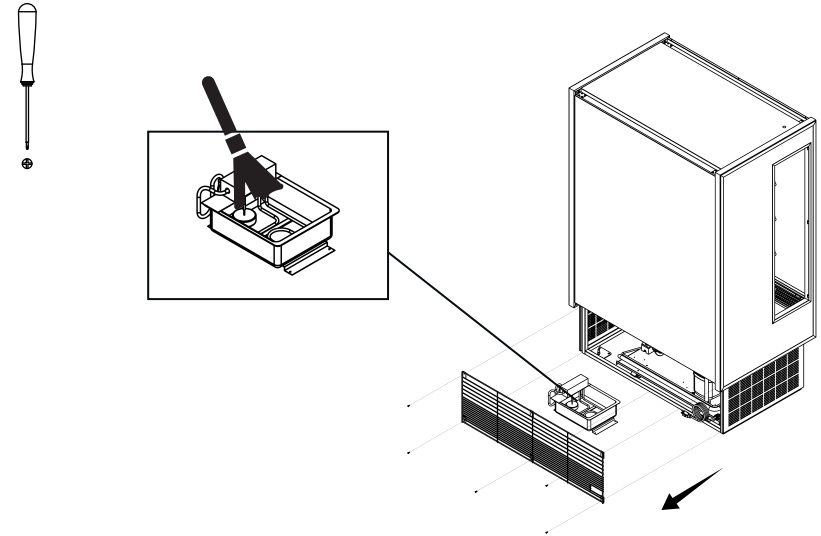

### 5.11 Drain inspection

-  Check for drain obstruction and correct position every month (Remotes only).

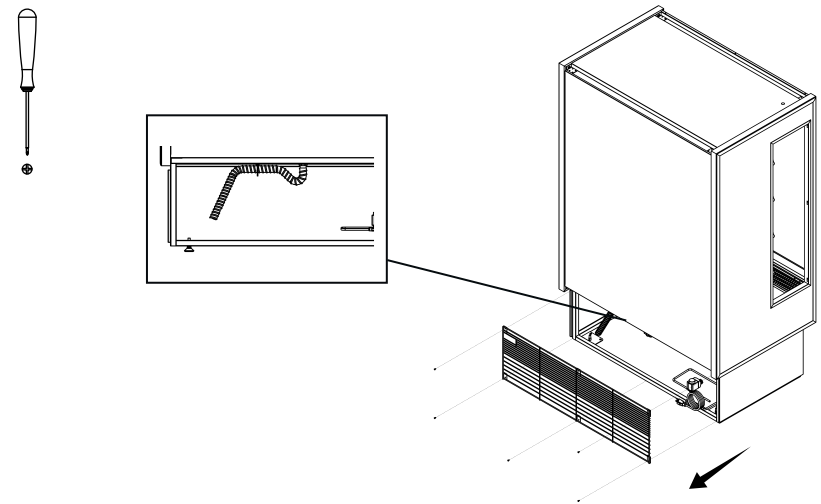



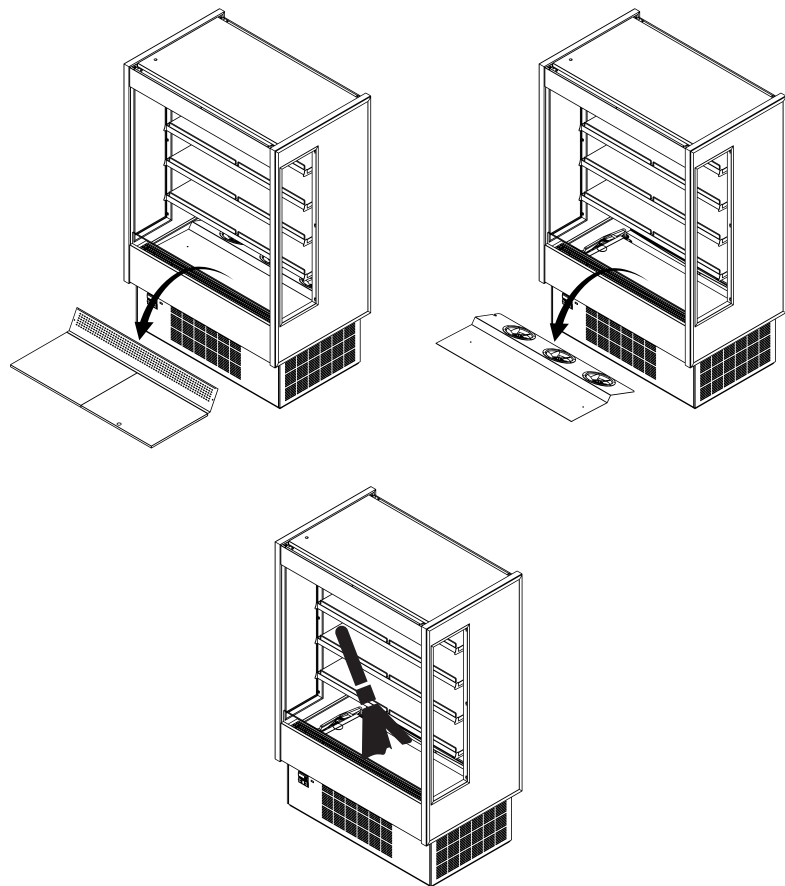

### 5.10 Evap Pan cleaning

- ⚠ This operation must be performed by a qualified technician.
- ⚠ All operations must be done with the unit disconnected.
- ⚠ Pan can be hot!
- ⚠ This operation must be done weekly.

To access the evap pan:

- Remove protection grille.
- Unplug the evap pan.
- Relieve the screws and take the evap pan off.
- Clean with soft detergent or warm water.

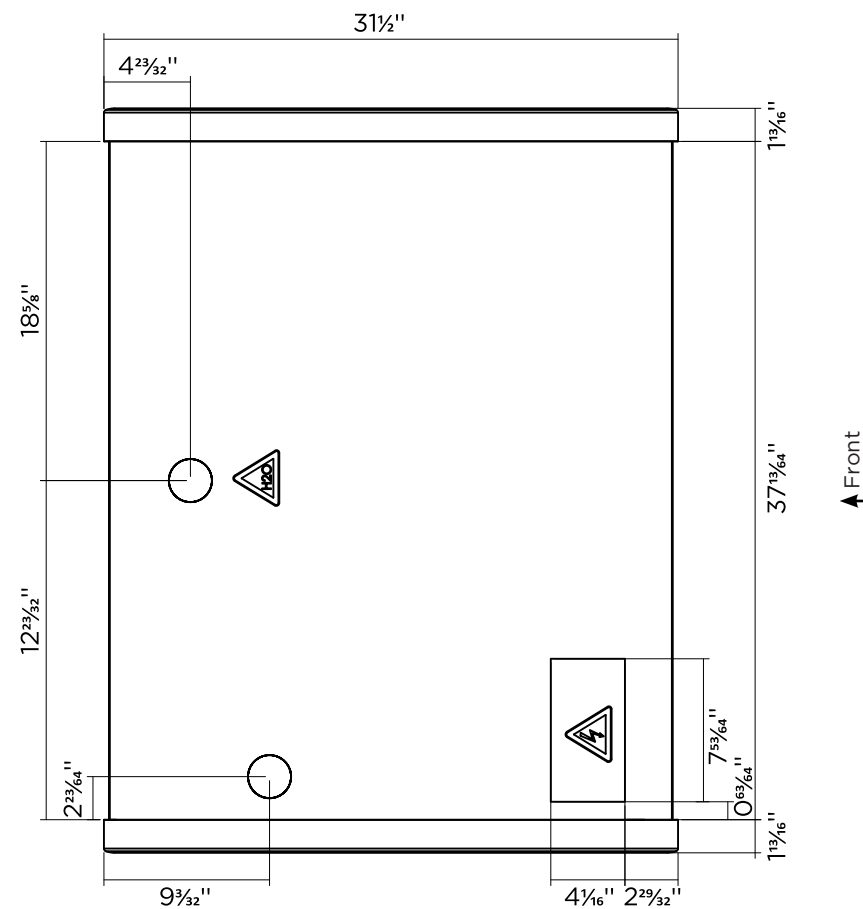

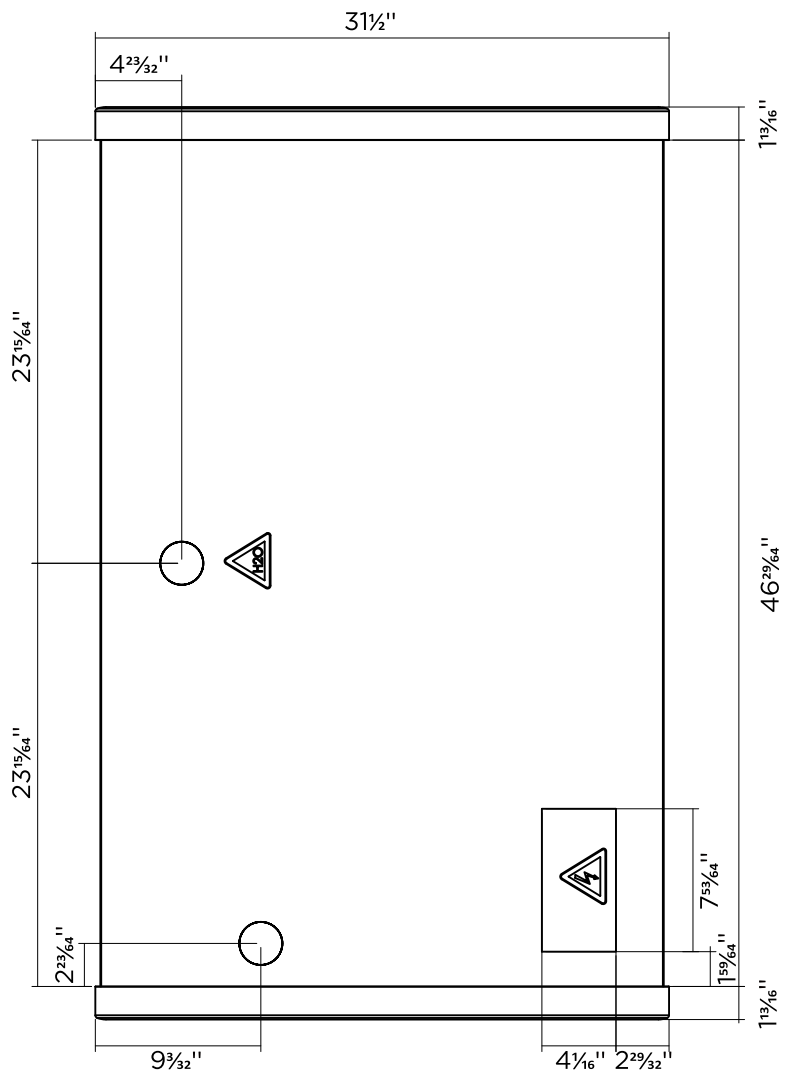

KGH-OF-40-R



KGH-OF-50-S

Front



### 5.8 Condenser cleaning

-  All operations must be performed by a qualified technician.
-  All operations must be done with the unit disconnected.

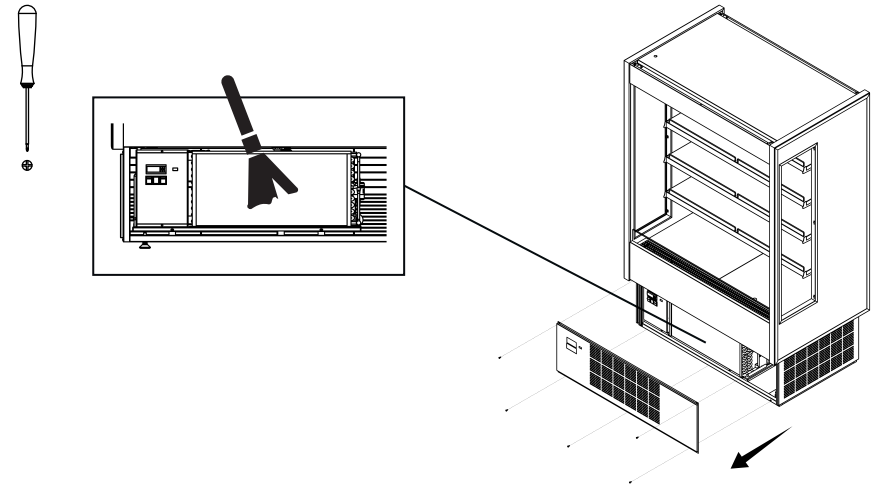
Condenser must be regularly cleaned (every month). Use a brush or vacuum it. To get to the condenser must remove frontal protection





### 5.9 Evaporator cleaning

-  All operations must be performed by a qualified technician.
-  All operations must be done with the unit disconnected.

To access the evaporator:

- Open your unit
- Lift and remove exposition panels
- Use tool for the screws and clean

## 5.7 Panels and protection grille removal

-  This operation must be performed by a qualified technician.
-  All operations must be done with the unit disconnected.

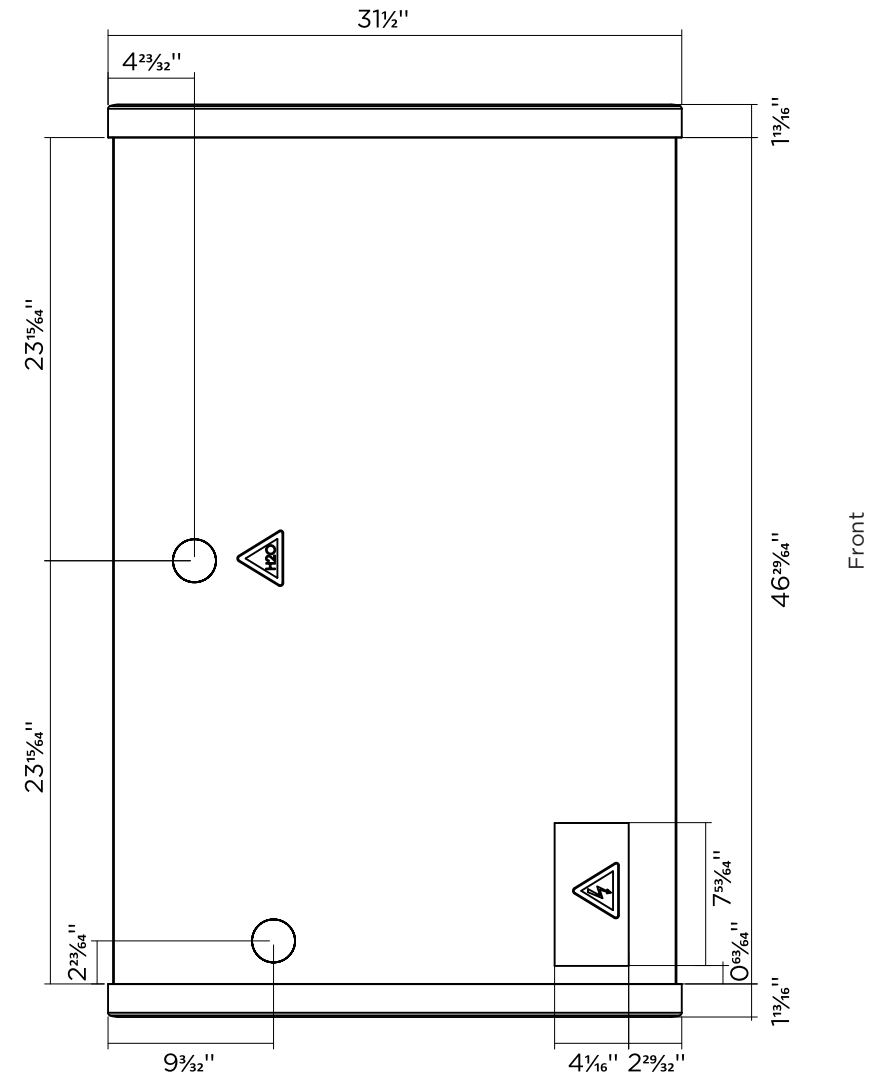
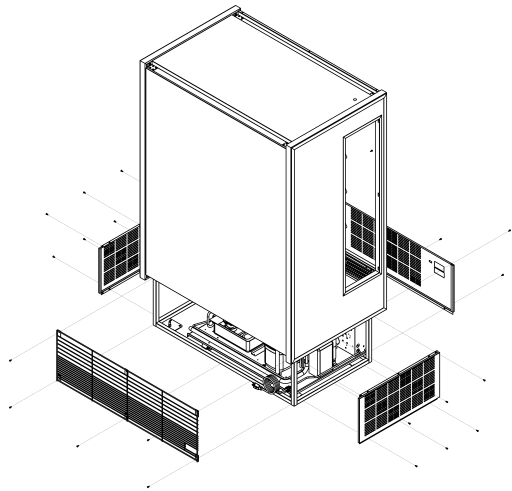
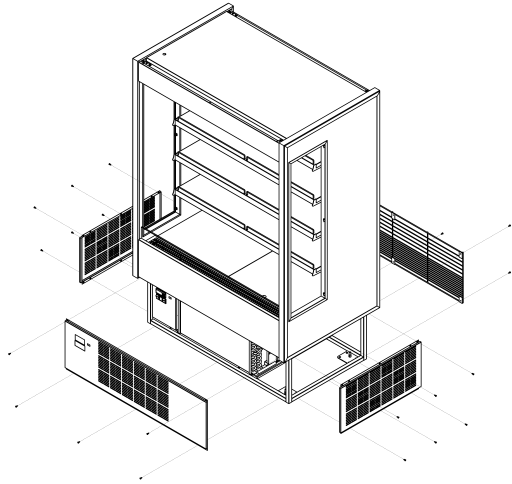

KGH-OF-50-R

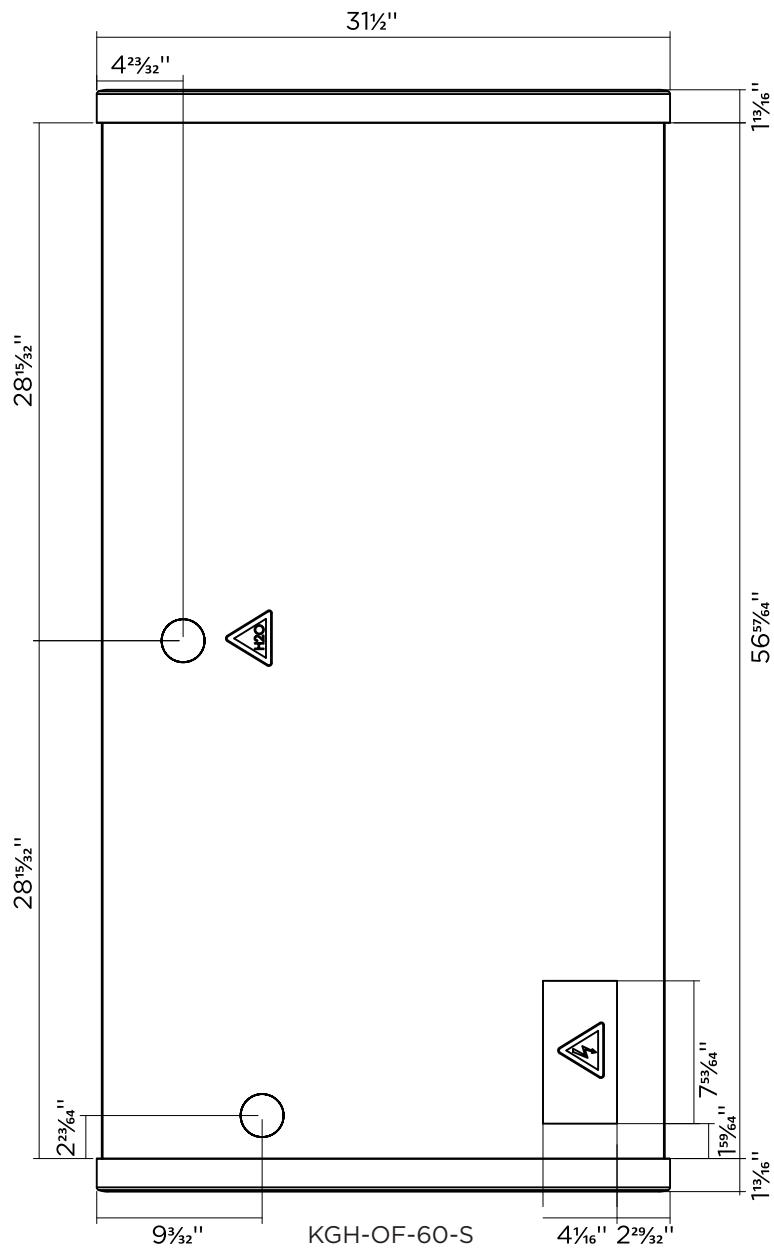

Front

4

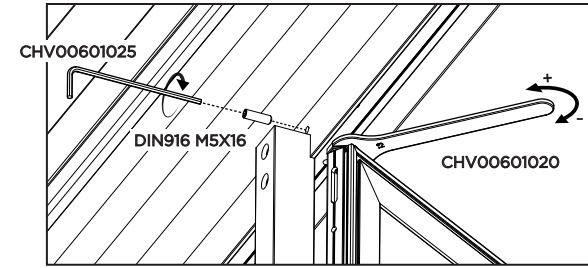

### 5.6 Light substitution

- ⚠ All operations must be performed by a qualified technician.
- ⚠ All operations must be done with the unit disconnected.

To replace lights follow the steps:

- Turn off power and unplug the equipment.
- Disconnect the light
- Unscrew the light holder and remove the light
- Insert a new light in the same place of the old one, screw the holder connect it
- Screw the light and connect it
- Plug and turn on the light

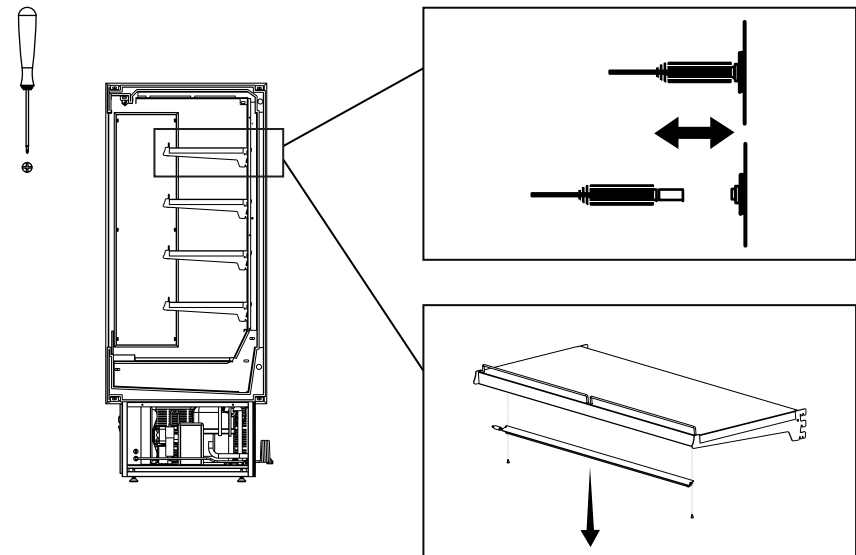

1

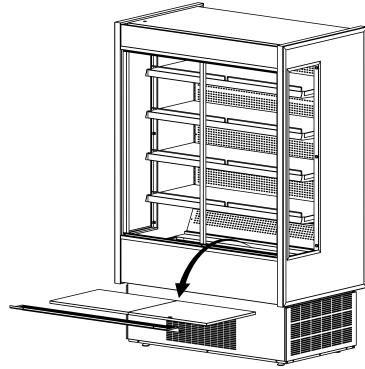

2

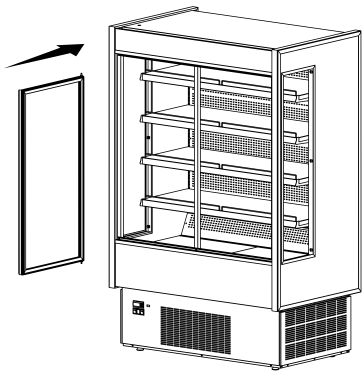

2.1

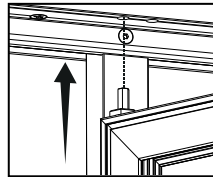

2.2

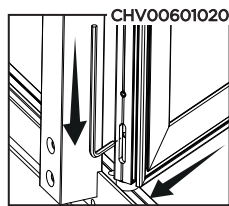

3

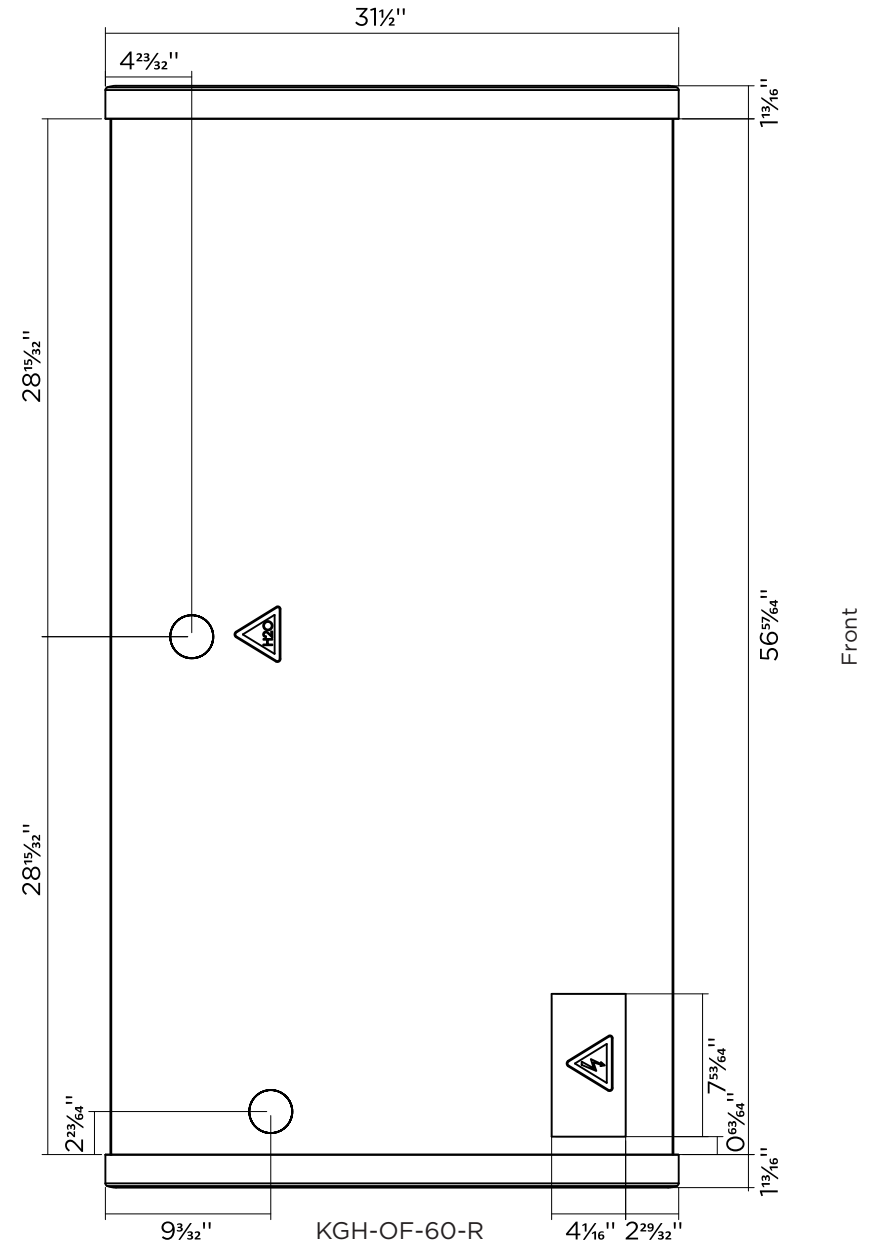
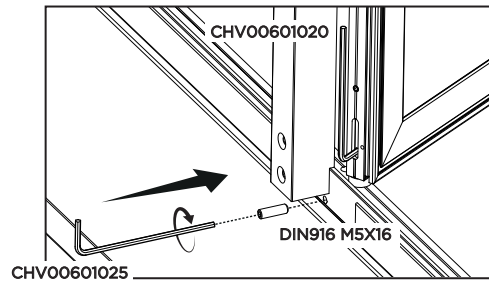

Front

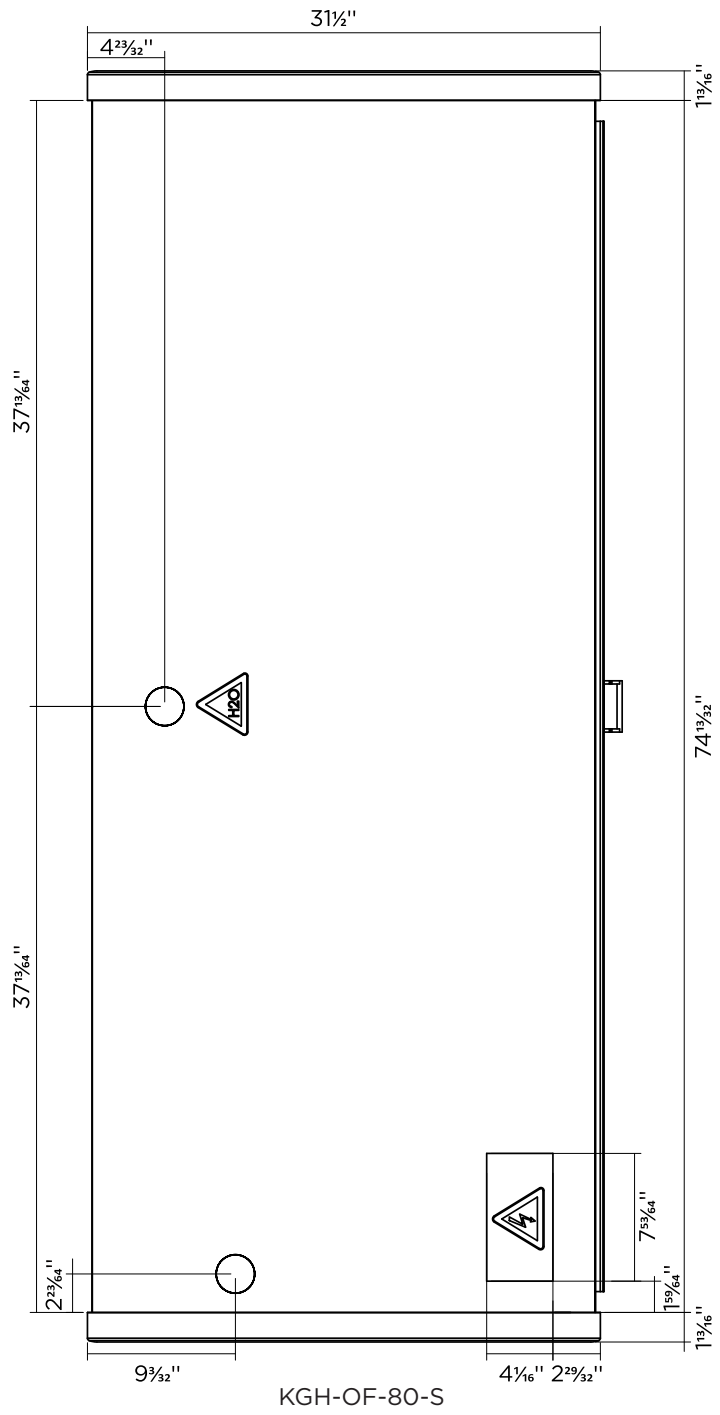

KGH-OF-80-S

Front

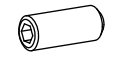

2x - DIN916 M5X16

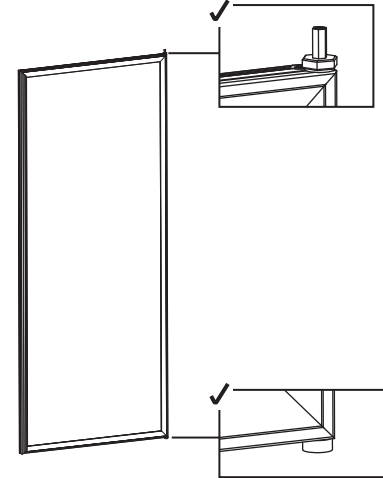

2x - POR07M03060

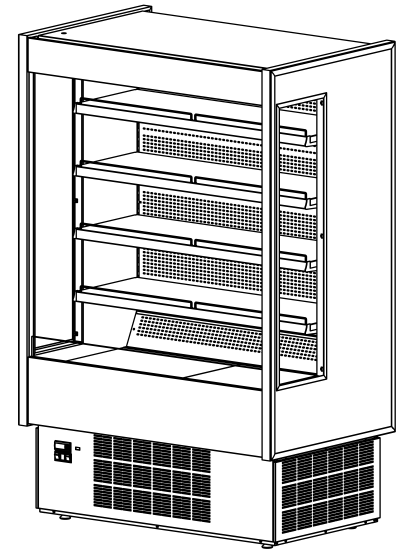

1x - KGH-FD/DS-S(R)

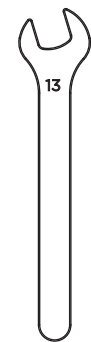

1x

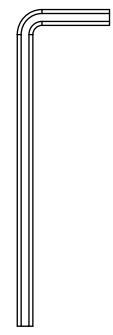

1x  
UMB 2

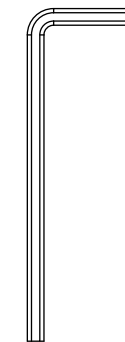

1x  
UMB 2.5

B

1

MOL01S02000 CAS00202000

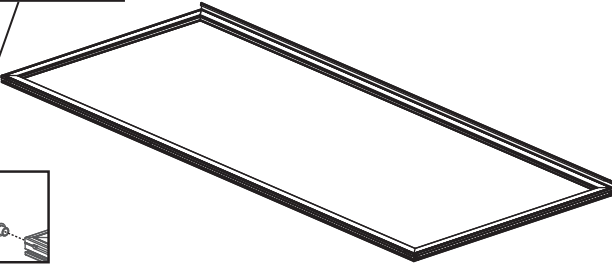
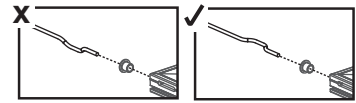

2

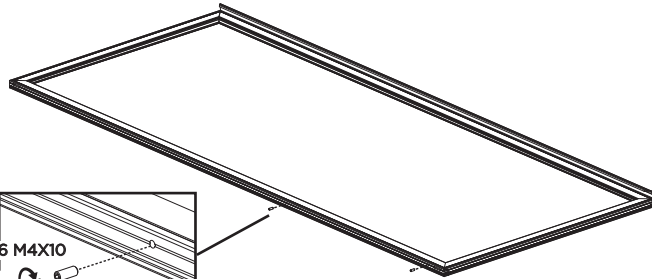

DIN916 M4X10  
2x

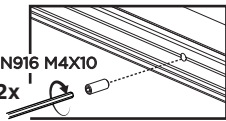

3

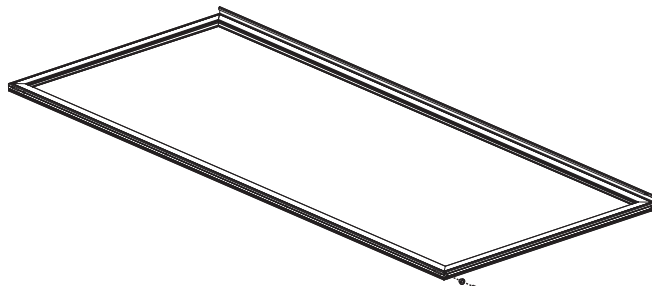
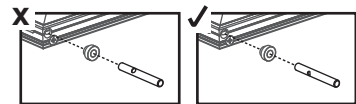

CAS00301000

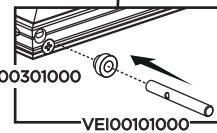

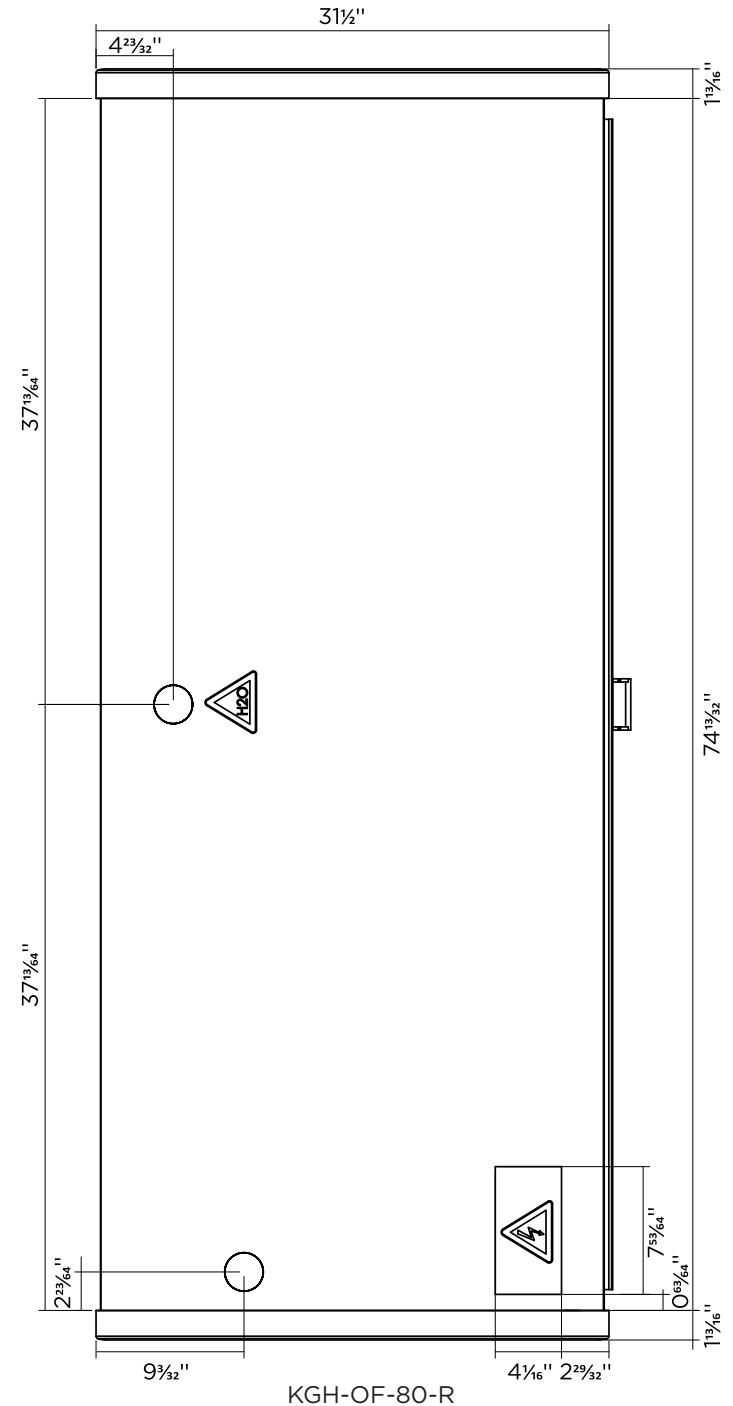

VEI00101000



KGH-OF-80-R

Front

# Implantation

-  Drain outlet
-  Electrical board
-  Refrigeration piping

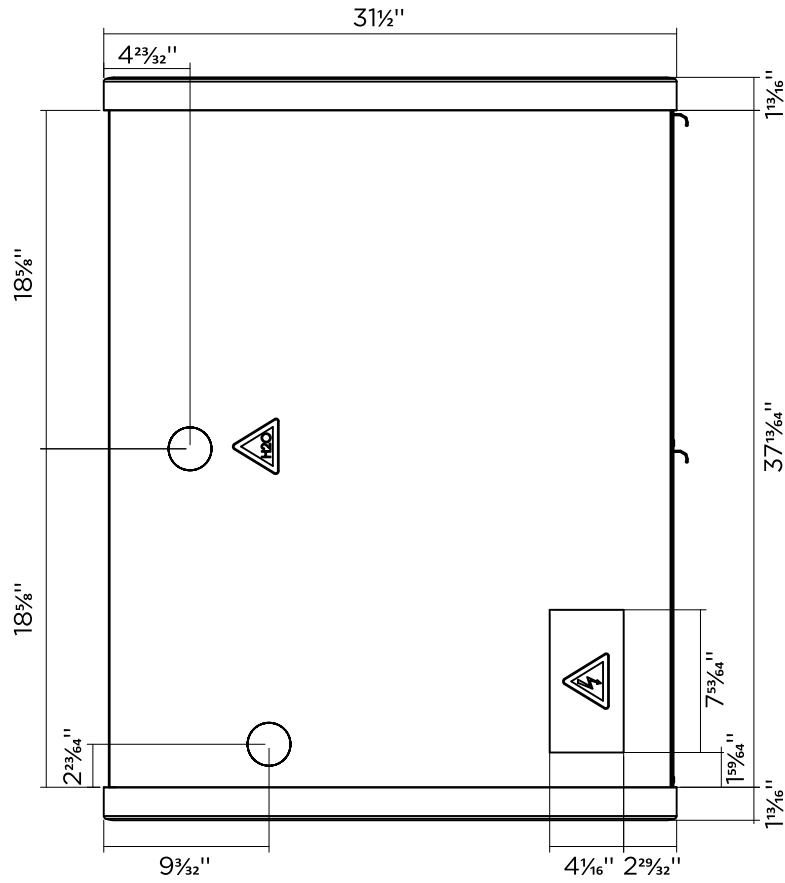

KGH-FD-40-S

↑ Front

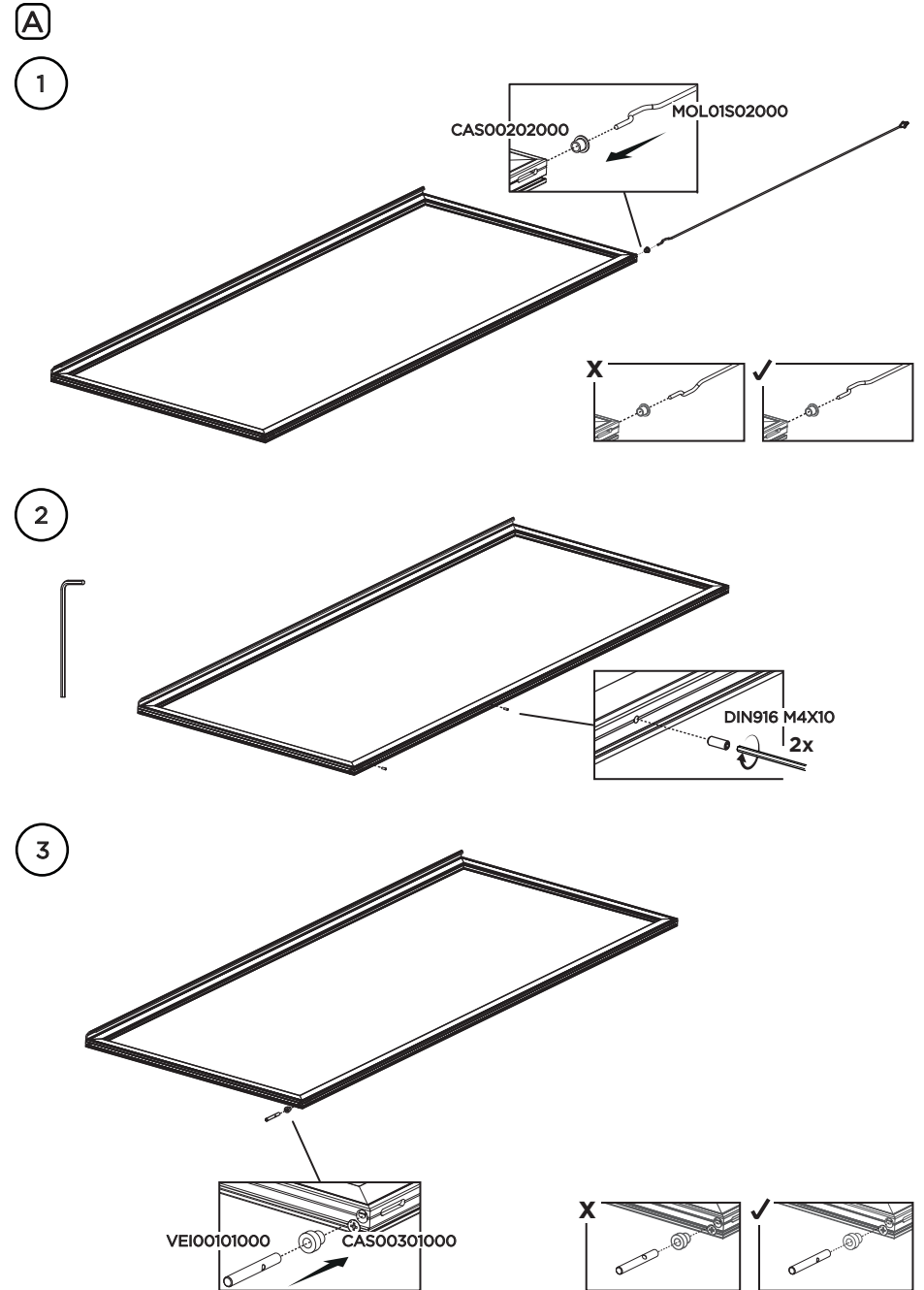



## 5.4 Front doors handling

### 5.4.1 Doors positions

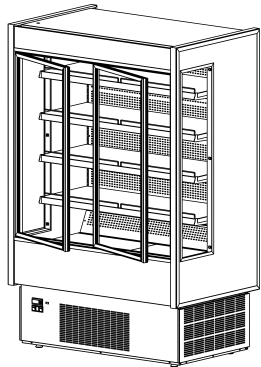

A-A

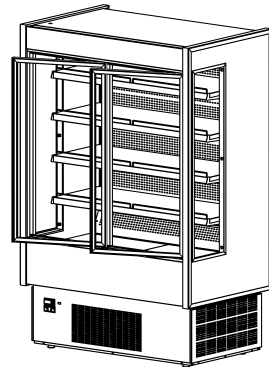

B-B

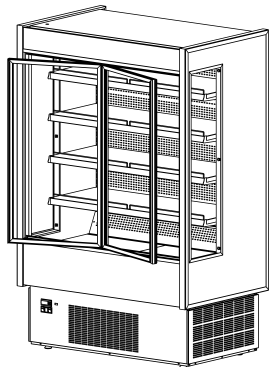

A-B

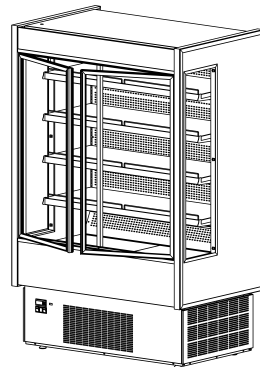

B-A

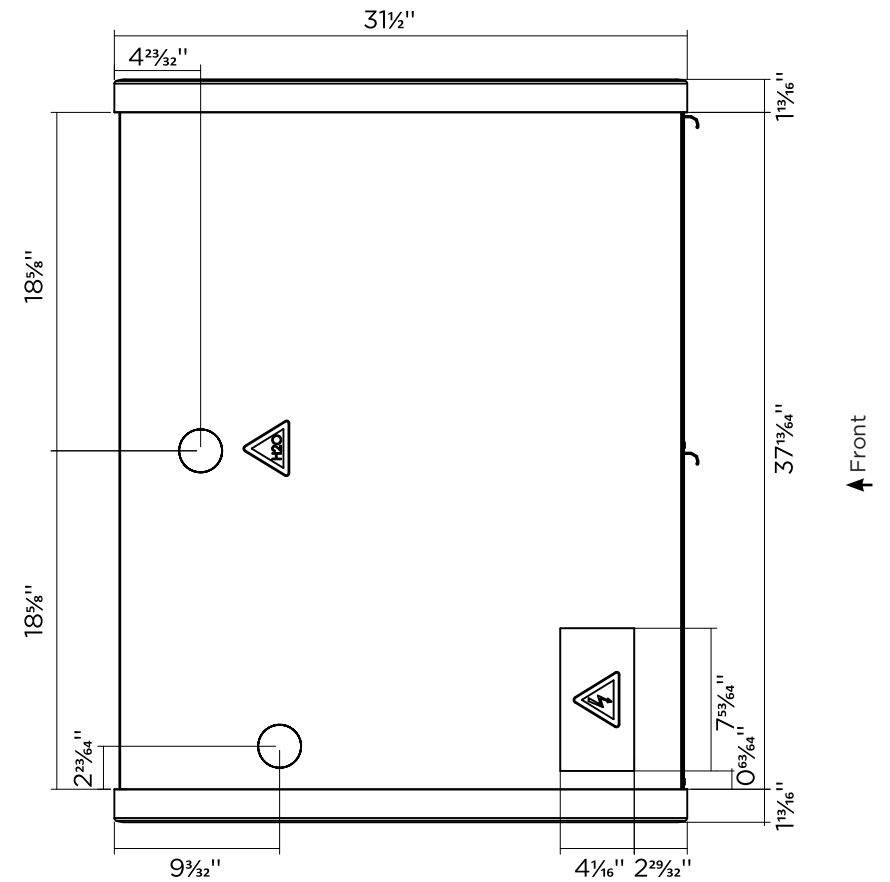

## 5.5 Door installation

- ⚠ All operations must be performed by a qualified technician.
- ⚠ All operations must be done with the unit disconnected.

KGH-FD-40-R

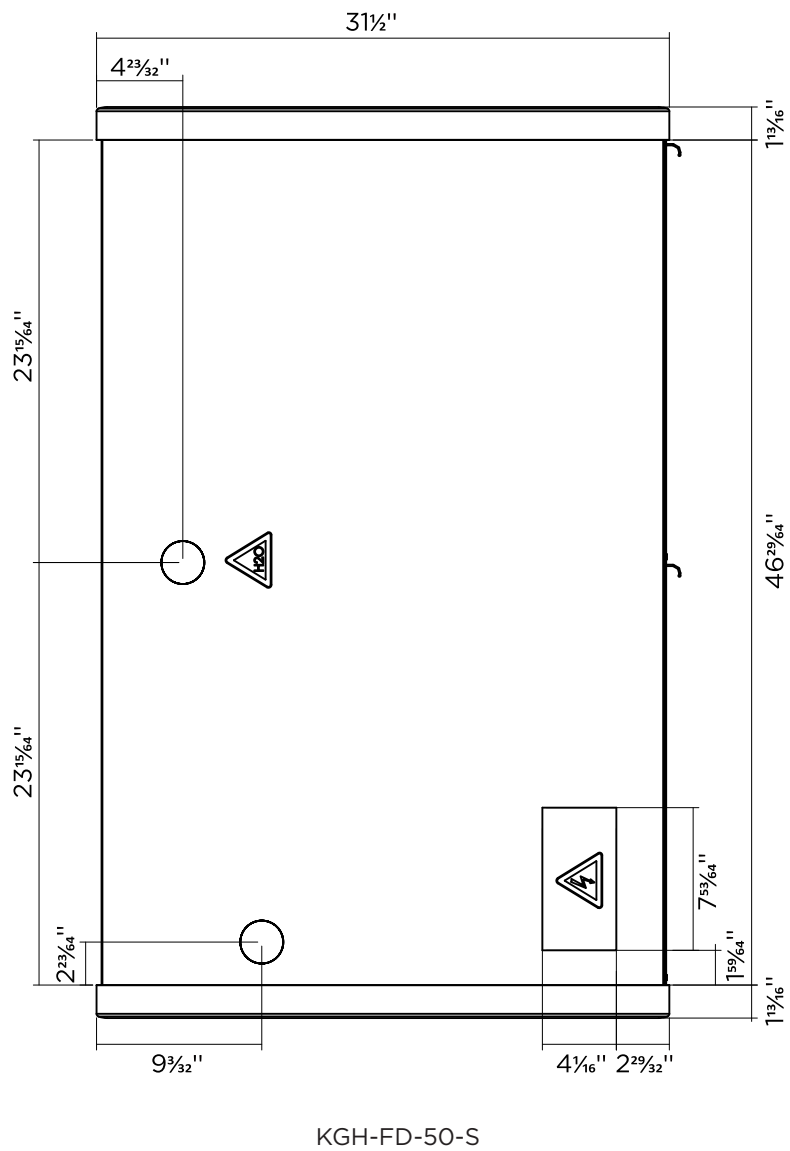

## 5.2 Interior cleaning

All operations must be done with the unit disconnected.

Clean surfaces (glass/metal/plastic) with soft detergent or warm water. Do not use abrasive cleanser.

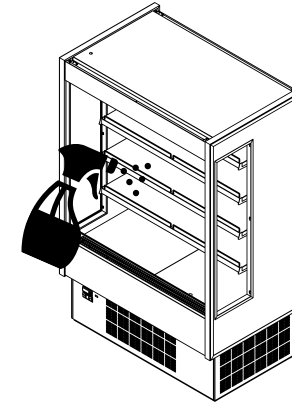

## 5.3 Shelf removing/adjustment

All operations must be done with the unit disconnected.

To remove or adjust shelves take care with light connections.

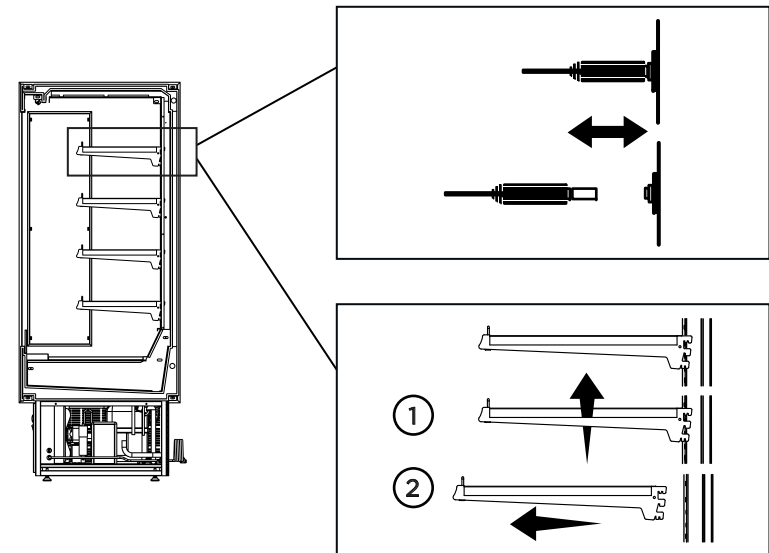

## Main parameters

Symbol	Code	Parameter	Models	UOM	Type	Min	Max	Def.
	/3	Probe display response	MSYF	-	C	0	15	0
	/5	Select °C or °F 0: °C 1: °F	MSYF	flag	C	0	1	0
🔑	/A2	Configuration of probe 2 (S2) 0: Probe absent 1: Product probe (display only) 2: Defrost probe 3: Condenser probe 4: Antifreeze probe	YF	-	C	0	4	2
			MS	-	C	0	4	2
	/c1	Calibration of probe 1	MSYF	°C/°F	C	-20	20	0,0
🌀	St	Temperature set point	MSYF	°C/°F	F	r1	r2	0,0
	rd	Control delta	SYF	°C/°F	F	0,1	20	2,0
🕒	c2	Minimum compressor OFF time	SYF	min	C	0	15	0
❄️	dl	Interval between defrosts	SYF	hours	F	0	250	8
	dP1	Maximum defrost duration, evaporator	SYF	min	F	1	250	30

## 5 Maintenance

### 5.1 Exterior cleaning

⚠️ All operations must be done with the unit disconnected.

Clean surfaces (glass/metal/plastic) with soft detergents or warm water. Do not use abrasive cleanser.

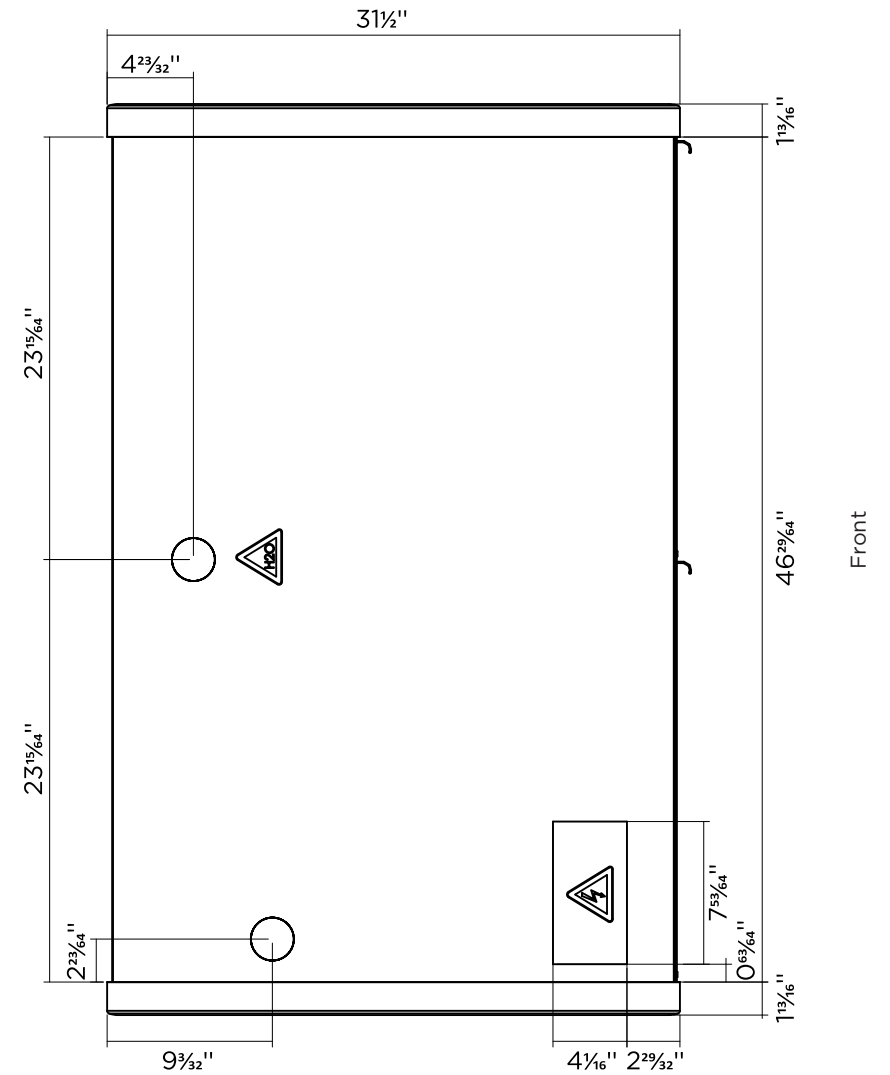
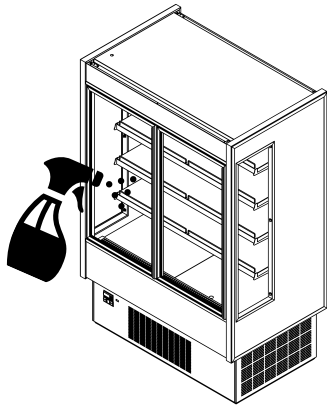

KGH-FD-50-R

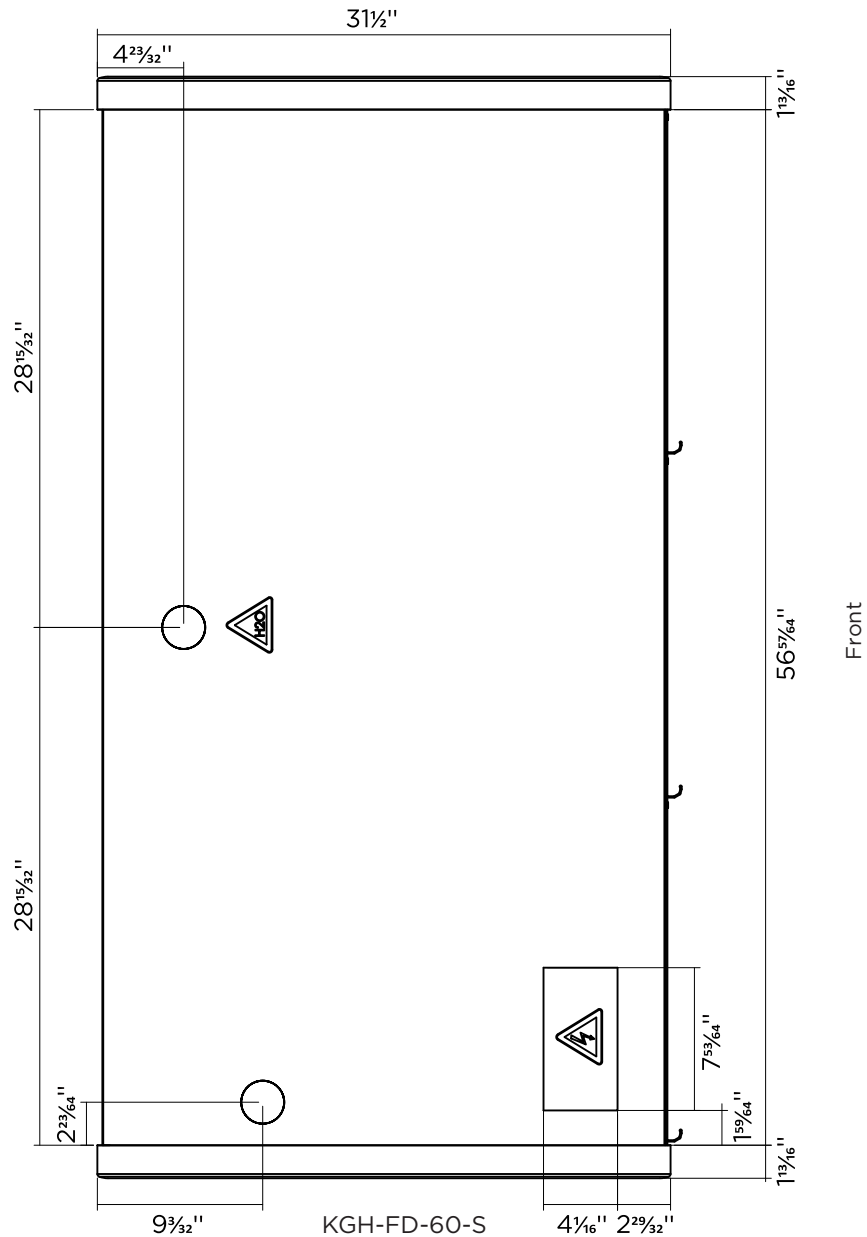

## Signals on the display

The blinking status indicates a request for activation that cannot be implemented until the end of the corresponding delay times.

Icon	Function	ON	OFF	blink	Startup
	COMPRESS.	compressor ON	comp. OFF	compressor request	
	FAN	fan ON	fan OFF	fan request	
	DEFROST	defrost in progress	defrost not required	defrost request	
	AUX	auxiliary output AUX active	auxiliary output AUX not active	anti-sweat heater function active	
	ALARM	delayed external alarm (before the expiry of the time "A7")	no alarm present	alarms in normal operation (eg. high/low temp.) or alarm from ext. digital input immediate or delayed	
	CLOCK	at least one timed defrost has been set	no timed defrost is present	clock alarm	ON if Real-Time Clock present
	LIGHT	auxiliary output LIGHT ACTIVE	auxiliary output LIGHT NOT ACTIVE	anti-sweat heater function active	
	SERVICE		no malfunction	malfunction (eg. EEPROM error or probe fault)	
	HACCP	HACCP function	HACCP function enabled	HACCP alarm (HA and/or HF) not enabled	
	CONTINUOUS CYCLE	enabled	not enabled	request	

Controller must be handled by a qualified technician.

## Buttons on the keypad

Button	Normal operation	
	Press. the button alone	Pressing together with other buttons
<b>Prg</b> mute	<ul style="list-style-type: none"> <li>if pressed for more than 5 s accessed the menu for setting type "F" (frequent) parameters</li> <li><b>in the event of alarm:</b> silences the audible alarm (buzzer) and disables the alarm relay</li> </ul>	<ul style="list-style-type: none"> <li>if pressed for more than 5 s together with the SET button, accesses the menu for setting the type "C" (configuration) or downloading the parameters</li> <li>if pressed for more than 5 s together with the UP/AUX button resets any alarm with manual reset</li> </ul>
 aux	if pressed for more than 1 s, enables/disables the auxiliary output	<ul style="list-style-type: none"> <li>if pressed for more than 5 s together with DOWN/DEF button, enables/disables the continuous cycle operation</li> <li>if pressed for more than 5 s with SET button, starts the procedure for printing the reports (function available, with management to be implemented)</li> <li>if pressed for more than 5 s together with PRG/MUTE button, resets any active alarm with manual reset</li> </ul>
<b>def</b> 	if pressed for more than 5 s, enables/disables a manual defrost	<ul style="list-style-type: none"> <li>if pressed for more than 5 s together with UP/AUX button, enables/disables the continuous cycle operation</li> <li>if pressed for more than 1 s together with SET button, displays a submenu with the HACCP alarm parameters (HA, HAn, HF, HFn)</li> </ul>
<b>Set</b>	if pressed for more than 1 s, displays and/or set the set point	<ul style="list-style-type: none"> <li>if pressed for more than 5 s together with PRG/MUTE button, accesses the menu for setting the type "C" parameters "C" (configuration) or downloading the parameters</li> <li>if pressed for more than 1 s together with DOWN/DEF button, displays a submenu with the HACCP alarm parameters (HA, HAn, HF, HFn)</li> <li>if pressed for more than 5 s together with UP/AUX, starts the procedure for printing the report (function available, with management to be implemented)</li> </ul>

Relay outputs	depending on the model				
	model	relay	EN 60730-1	UL 873	
			250 V~	operating cycles	250 V~
					operating cycles
IRxxxx(E,A) (P,Q,S,U,V,X,Y,Z)xxx	R2 (*)	5(1)A	100000	5 A resistive 1FLA 6 LRA C 300	300000
IRxxxx(E,A) (N,R,C,B,A,M,L,T)xxx	R3 (*)	5(1)A	100000	5 A resistive 1FLA 6 LRA C 300	300000
IRxxxx(E,A) (N,R,C,B,A,M,L,T)xxx	R1,R2	8 (4)A N.O. 6 (4)A N.C.	100000	8 A resistive 2FLA 12 LRA C300	300000
IRxxxx(O,L,H) (N,R,C,B,A,M,L,T)xxx	R2,R3 R4 (*)	2 (2)A N.O./N.C.			
IRxxxx(E,A) (P,Q,S,U,V,X,Y,Z)xxx	R1	12 (2)A N.O./N.C.	100000	12 A resistive 5FLA 30 LRA C300	300000
IRxxxx(O,L,H) (N,R,C,B,A,M,L,T)xxx	R1 (*)				
insulation from very low voltage parts			reinforced		
			6 mm clearance, 8 mm creepage		
			3750 V insulation		
insulation between the relay outputs independent			basic		
			3 mm clearance, 4 mm creepage		
			1250 V insulation		

**SSR outputs** Max output voltage : 12 Vdc, Output resistance: 600 Ω, Max output current: 20 mA

(\*): Relay not suitable for fluorescent loads (neon lights, ...) that use starters (ballasts) with phase-shift capacitors. Fluorescent lamps with electronic control devices or without phase-shift capacitors can be used, within the operating limits specified for each type of relay.

Connessioni	Type of connection			Cross-section Max. current
Model	Relay screw	P. Supply screw	Probes screw	for wires from 12 A
IRxxxxxx0xx	faston	faston	removable	0.5 a 2.5 mm <sup>2</sup>
IRxxxx(E,A)x1xx	removable	removable	removable	
IRxxxxxx2xx	faston	faston	removable	
IRxxxx(E,A)x3xx	vertical screw	vertical screw	screw	
IRxxxx(E,A)x5xx	vertical screw	vertical screw	vertical screw	

the installer has to provide the correct dimensioning of the power supply and cable connection between the instruments and the loads. Depending on the model, the maximum current in the common terminals 1, 3 or 5 is 12 A. When using the controller at maximum operating temperature and full load, use cables featuring a maximum operating temperature of 105 °C at least.

 Controller must be handled by a qualified technician.

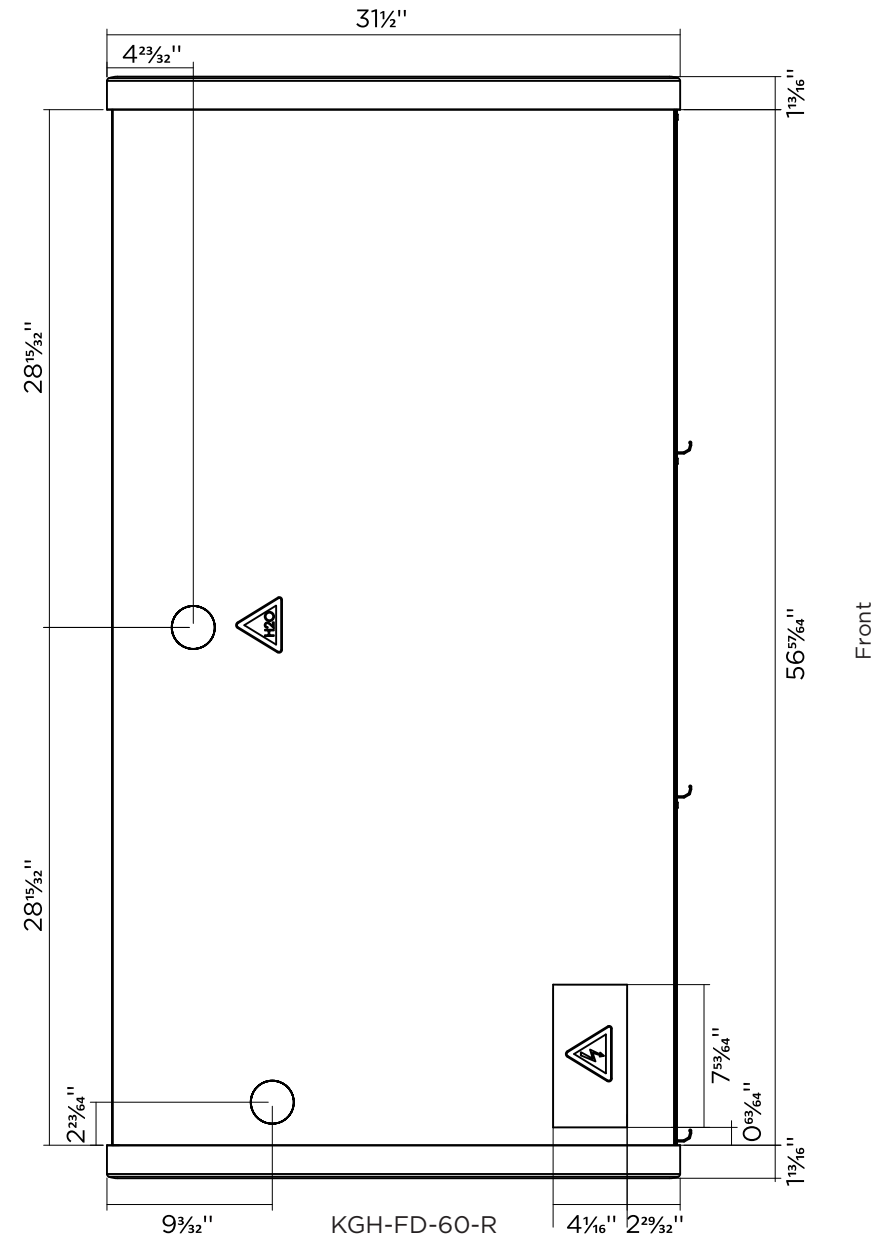

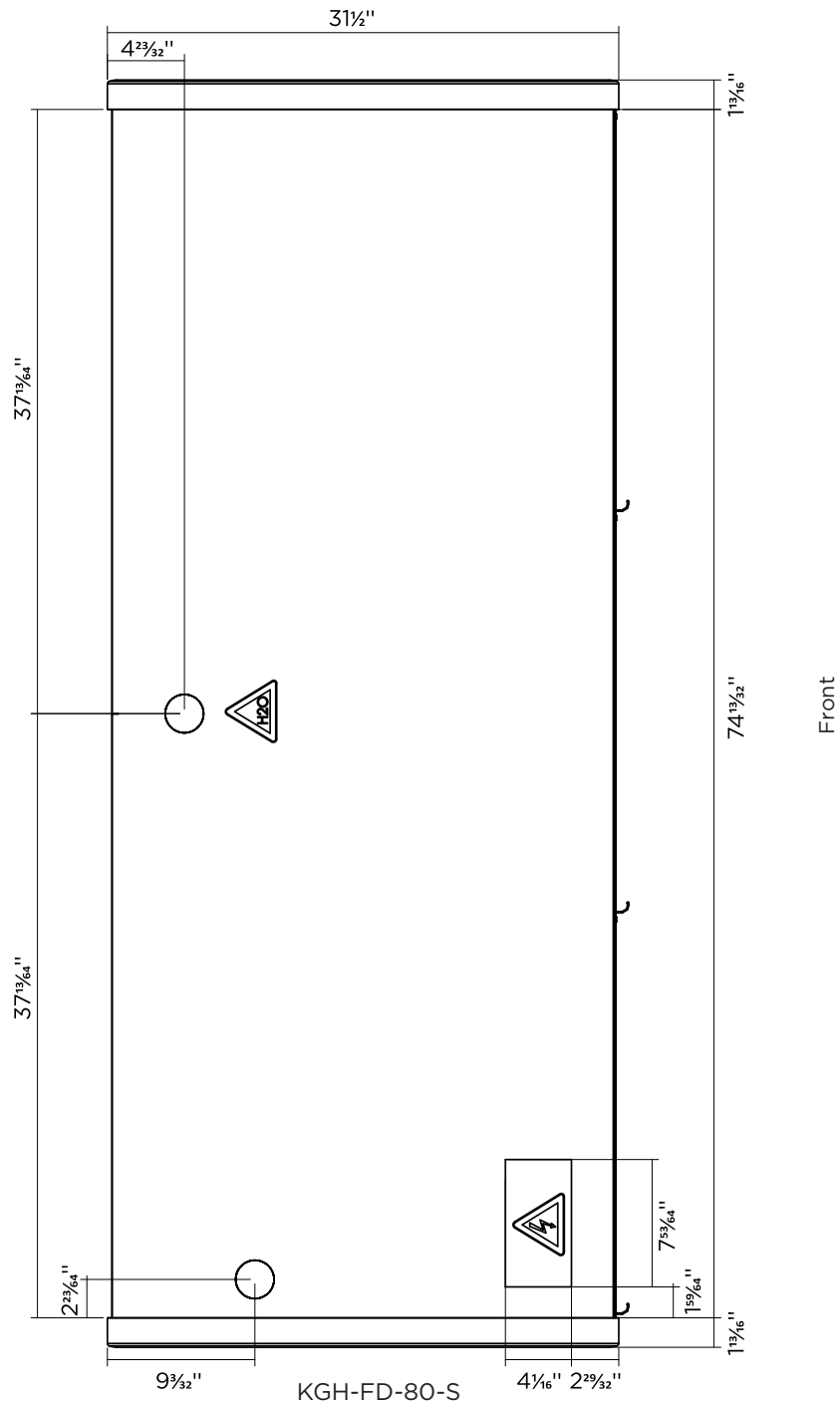

Front

#### 4.4. Electronic controller



Carel - IR33FOAHEO



#### TECHNICAL SPECIFICATIONS

	<b>Model</b>	<b>Voltage</b>	<b>Power</b>
<b>Power supply</b>	IRxxxExxxx	230 V~, 50/60 Hz	3 VA, 25 mA~max.
	IRxxxAxxxx	115V~, 50/60 Hz	3 VA, 50 mA~max.
	IRxxxHxxxx	115 to 230 V~, 50/60 Hz	6 VA, 50 mA~max.
	IRxxxLxxxx IRxxx0xxxx	12 to 24V~, 50/60 Hz, 12 to 30 Vdc 12V~, 50/60 Hz, 12 to 18 Vdc	3 VA, 300 mA~/mAdc max. Use only SELV power supply
<b>Insulation guaranteed by the power supply</b>	IRxxxExxxx IRxxxAxxxx IRxxxHxxxx	insulation in reference to very low voltage parts	reinforced 6mm clearance, 8 mm creepage 3750 V insulation
		insulation from relay outputs	basic 3mm clearance, 4 mm creepage 1250V insulation
	IRxxxLxxxx	insulation in reference to very low voltage parts	externally guaranteed by safety transformer (SELV power supply)
	IRxxx0xxxx	insulation from relay outputs	reinforced 6mm clearance, 8 mm creepage 3750 V insulation
<b>Inputs</b>	S1 (probe 1)	NTC (IRxxx0xxxxx) o NTC e PTC (IRxxx7xxxxx)	
	S2 (probe 2)	NTC (IRxxx0xxxxx) o NTC e PTC (IRxxx7xxxxx)	
	DI 1 S3 (probe 3)	free contact, contact resistance < 10 Ω, closing current 6 mA NTC (IRxxx0xxxxx) o NTC e PTC (IRxxx7xxxxx)	
	DI 2 S4 (probe 4)	free contact, contact resistance < 10 Ω, closing current 6 mA NTC (IRxxx0xxxxx) o NTC e PTC (IRxxx7xxxxx)	
	<b>Maximum distance of probes and digital inputs less than 10 m.</b> <b>Note:</b> during installation keep the power and loads connection separate from probe cables, digital inputs, repeater display and supervisory system.		
<b>Probe type</b>	Std. CAREL NTC	10 kΩ at 25 °C, - 50T90 °C range	measurement error: 1 °C in the - 50T50 °C range 3 °C in the - 50T90 °C range
		50 kΩ at 25 °C, - 40T150 °C range	measurement error: 1,5 °C in the - 20T115 °C range 4 °C in the - 20T115 °C range
	NTC high temperature	985 Ω a 25 °C, range da - 50T150 °C	measurement error: 2 °C in the - 50T50 °C range 4 °C in the - 50T150 °C range
	PTC std. CAREL (specific model)		

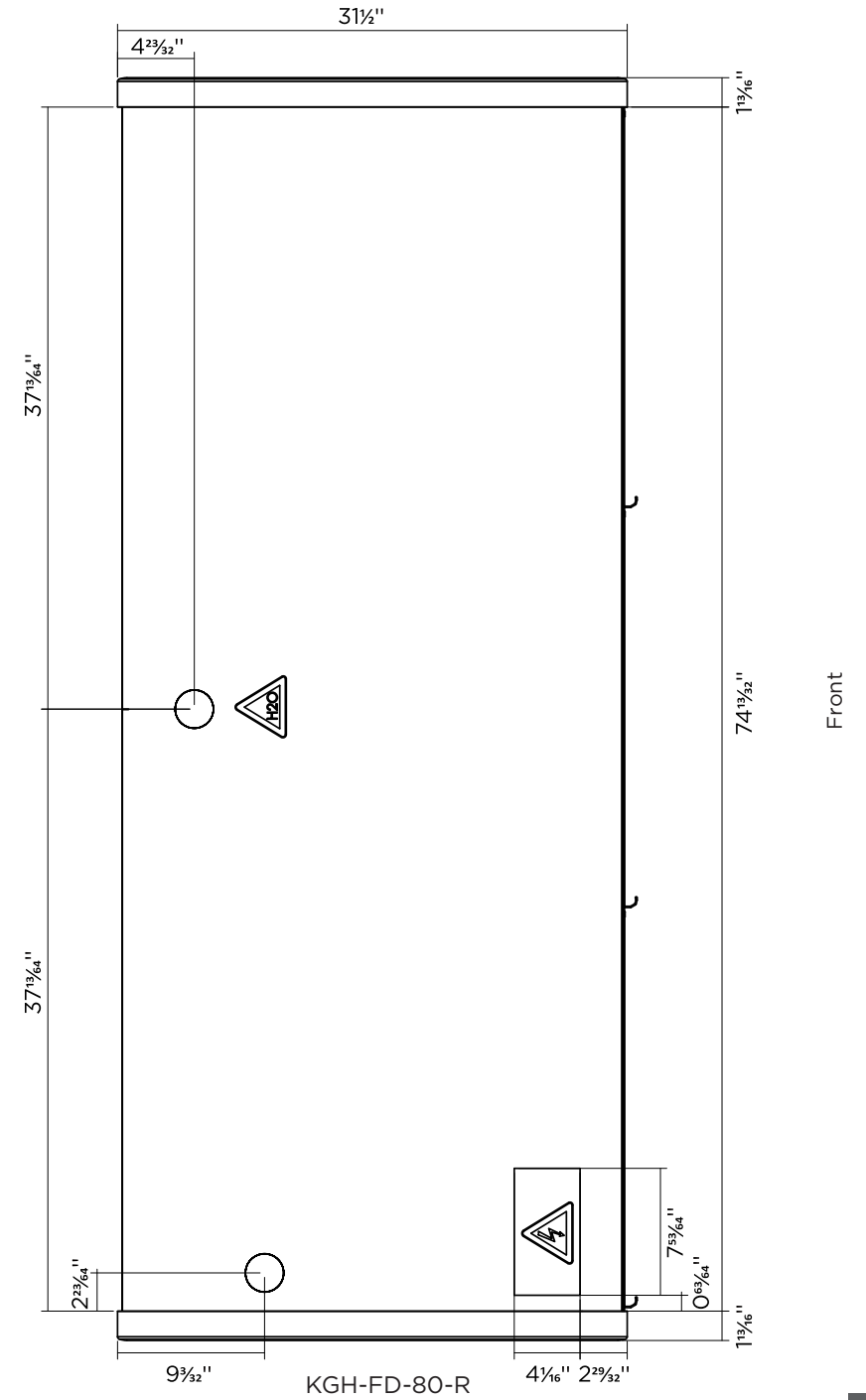
N <sup>o</sup>	Description
1	Compressor
2	Overload
3	Relay
4	Start capacitor
5	Condenser fan
6	Controller
7	Temperature probe
9	Terminal block
11	Ground connection
12	Evaporator fan
13	Compressor relay
21	Pilot light
22	Switch
27	Run capacitor
28	Time delay relay
29	Transformer
30	Led lighting
31	Socket
32	Evaporative condensate pan
43	Electrical shutter
44	A key switch shutter



Implantation

-  Drain outlet
-  Electrical board
-  Refrigeration piping

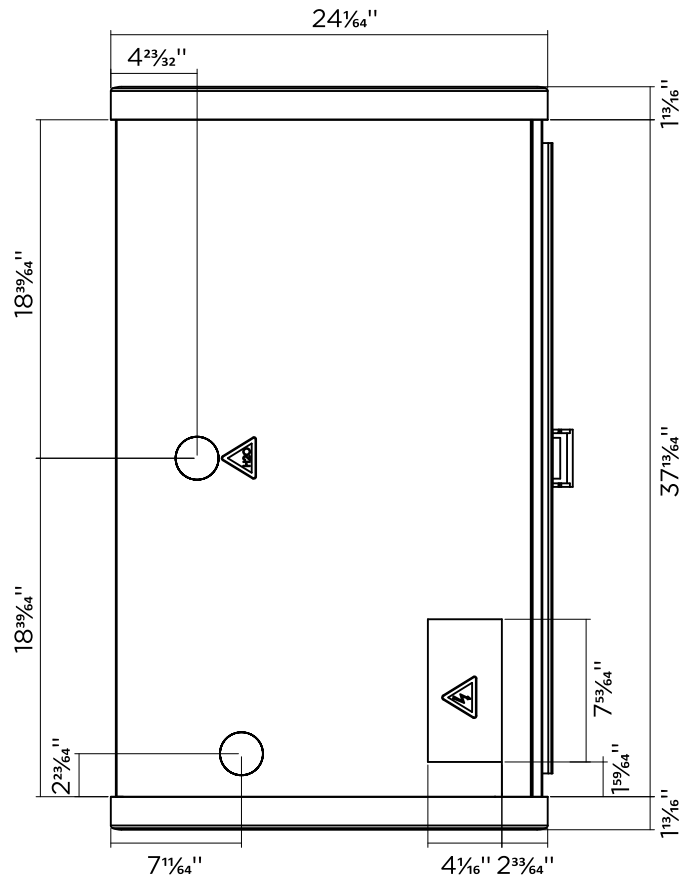

KGH-OS-40-S

KGH-ES-80-S

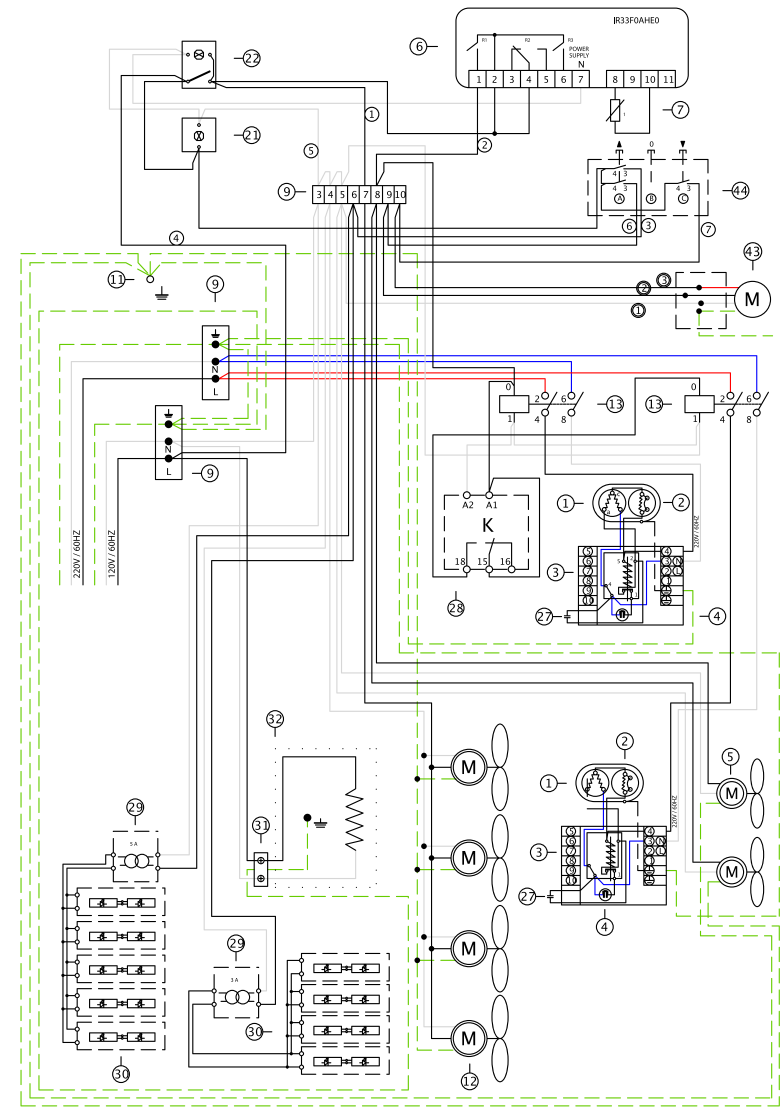



N <sup>o</sup>	Discription
1	Compressor
2	Overload
3	Relay
4	Start capacitor
5	Condenser fan
6	Controller
7	Temperature probe
9	Terminal block
11	Ground connection
12	Evaporator fan
13	Compressor relay
21	Pilot light
22	Switch
27	Run capacitor
29	Transformer
30	Led lighting
31	Socket
32	Evaporative condensate pan
43	Electrical shutter
44	A key switch shutter

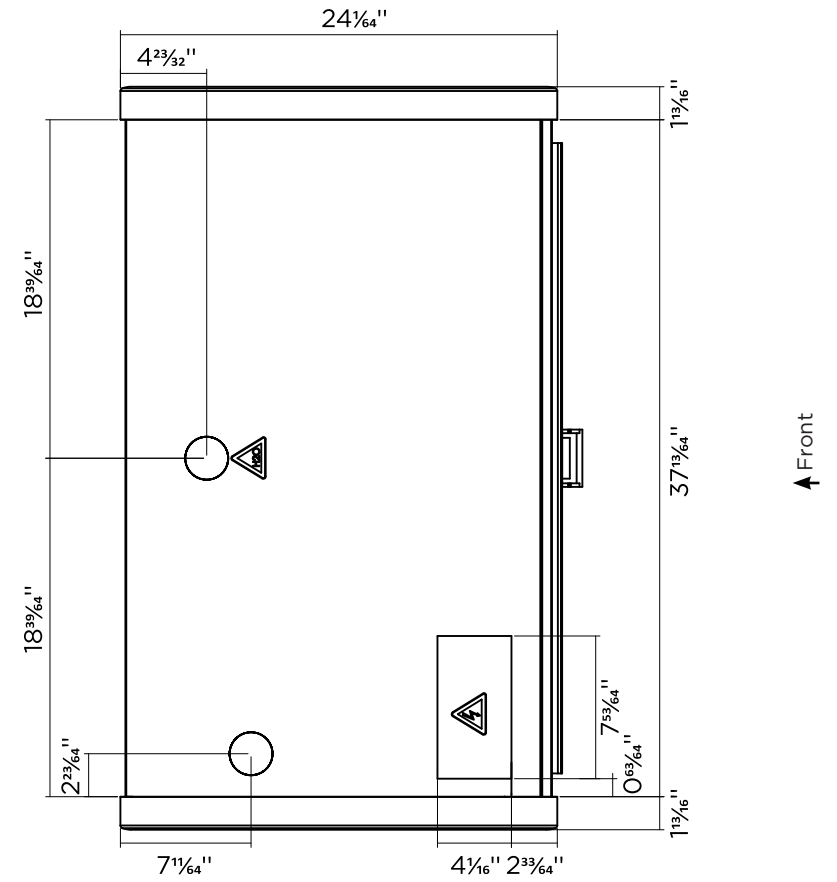

KGH-OS-40-R



N <sup>o</sup>	Description
1	Compressor
2	Overload
3	Relay
4	Start capacitor
5	Condenser fan
6	Controller
7	Temperature probe
9	Terminal block
11	Ground connection
12	Evaporator fan
13	Compressor relay
20	Light switch
21	Pilot light
22	Switch
27	Run capacitor
29	Transformer
30	Led lighting
31	Socket
32	Evaporative condensate pan

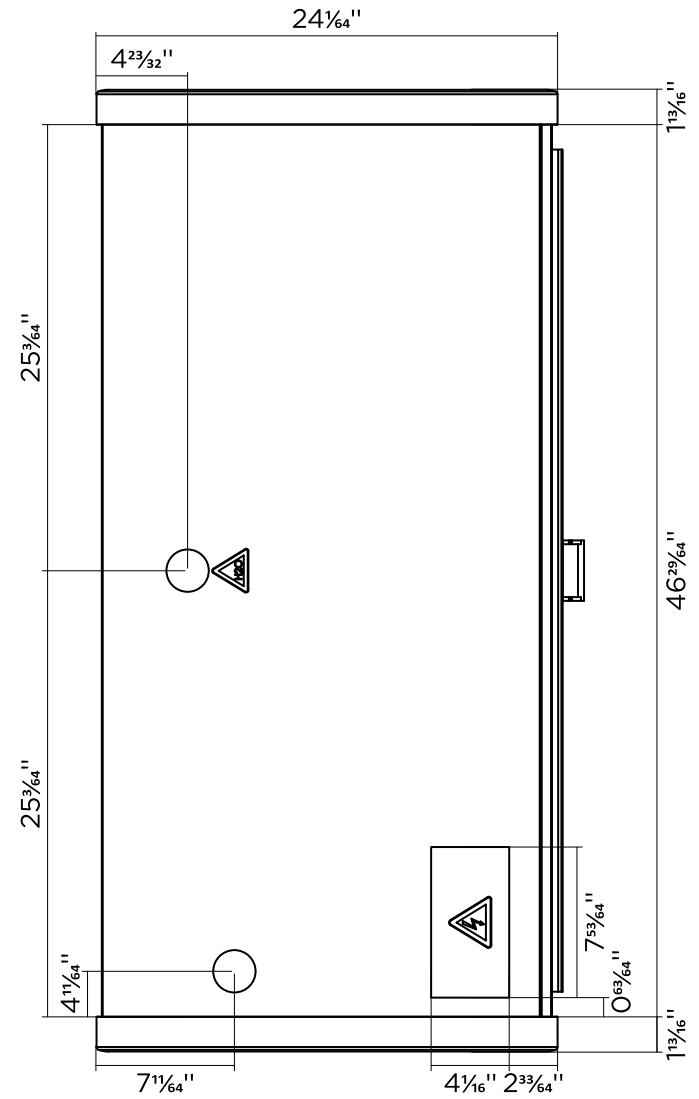

KGH-OS-50-R

Front

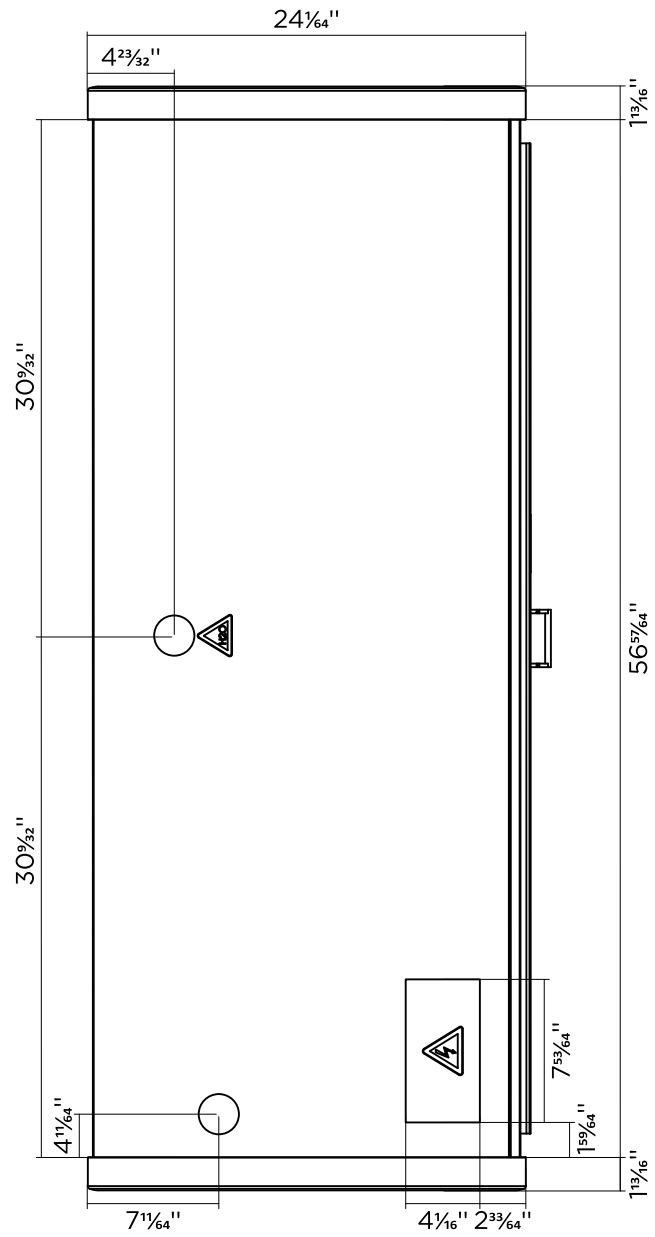

KGH-OS-60-S

Front

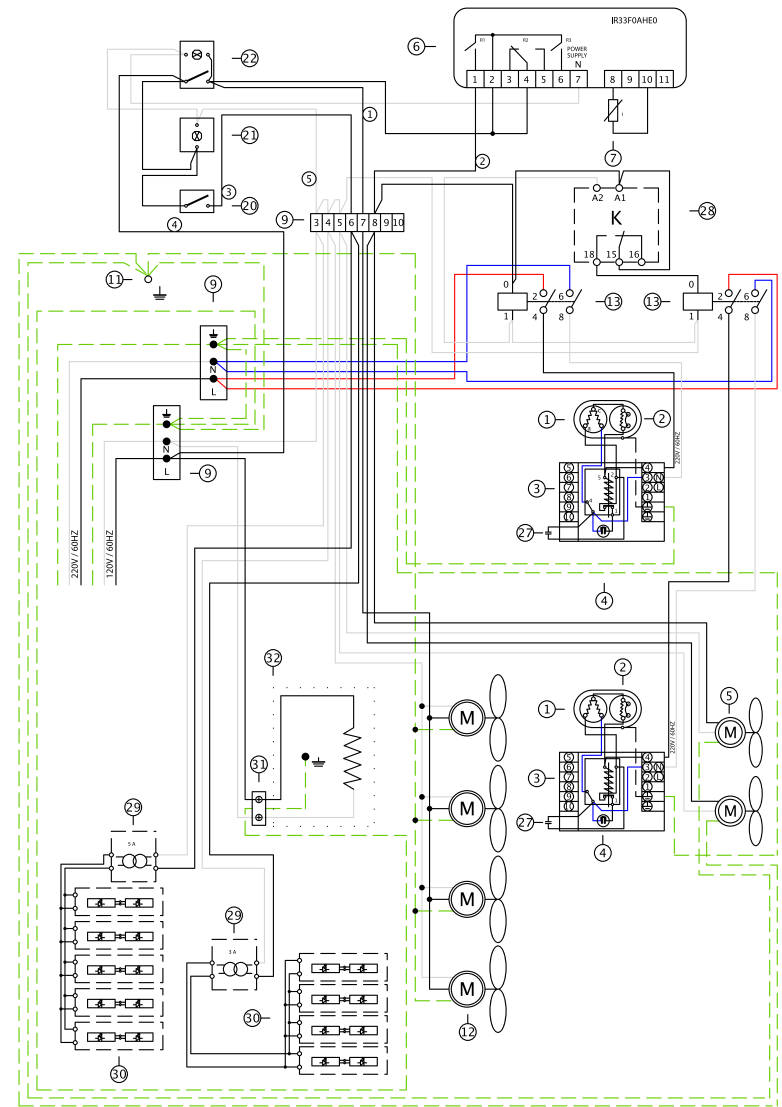

KGH-OF-80-S

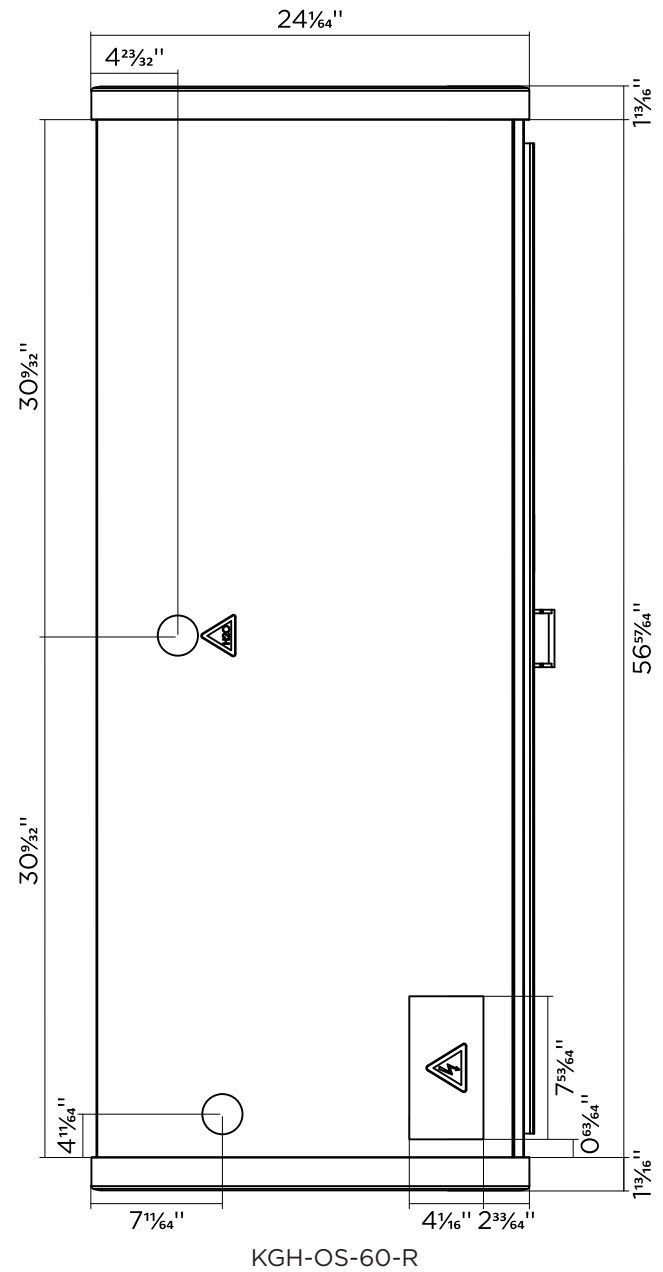

N <sup>o</sup>	Description
1	Compressor
2	Overload
3	Relay
4	Start capacitor
5	Condenser fan
6	Controller
7	Temperature probe
9	Terminal block
11	Ground connection
12	Evaporator fan
13	Compressor relay
20	Light switch
21	Pilot light
22	Switch
27	Run capacitor
29	Transformer
30	Led lighting
31	Socket
32	Evaporative condensate pan



Implantation

-  Drain outlet
-  Electrical board
-  Refrigeration piping

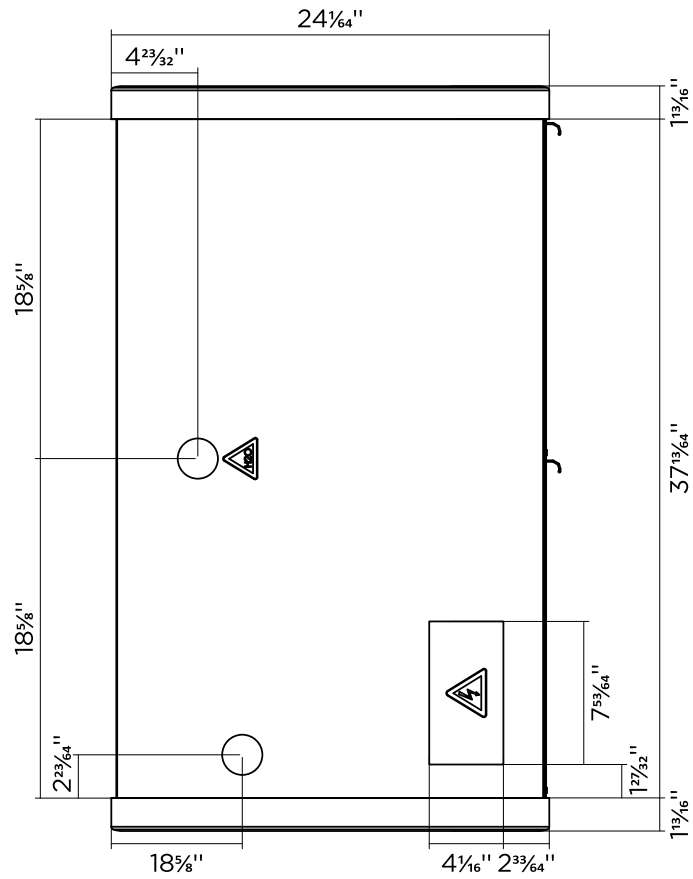

KGH-DS-40-S

KGH-OF-60-S

↑ Front

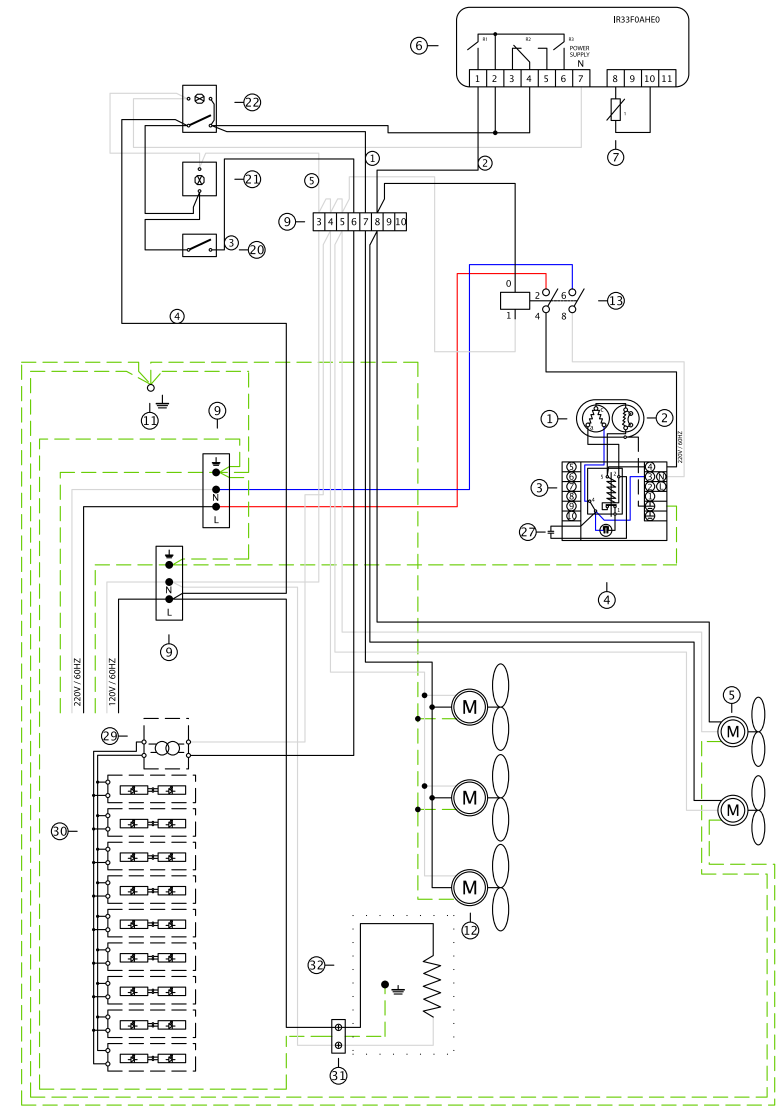

Nº	Discription
1	Compressor
2	Overload
3	Relay
4	Start capacitor
5	Condenser fan
6	Controller
7	Temperature probe
9	Terminal block
11	Ground connection
12	Evaporator fan
13	Compressor relay
20	Light switch
21	Pilot light
22	Switch
27	Run capacitor
29	Transformer
30	Led lighting
31	Socket
32	Evaporative condensate pan

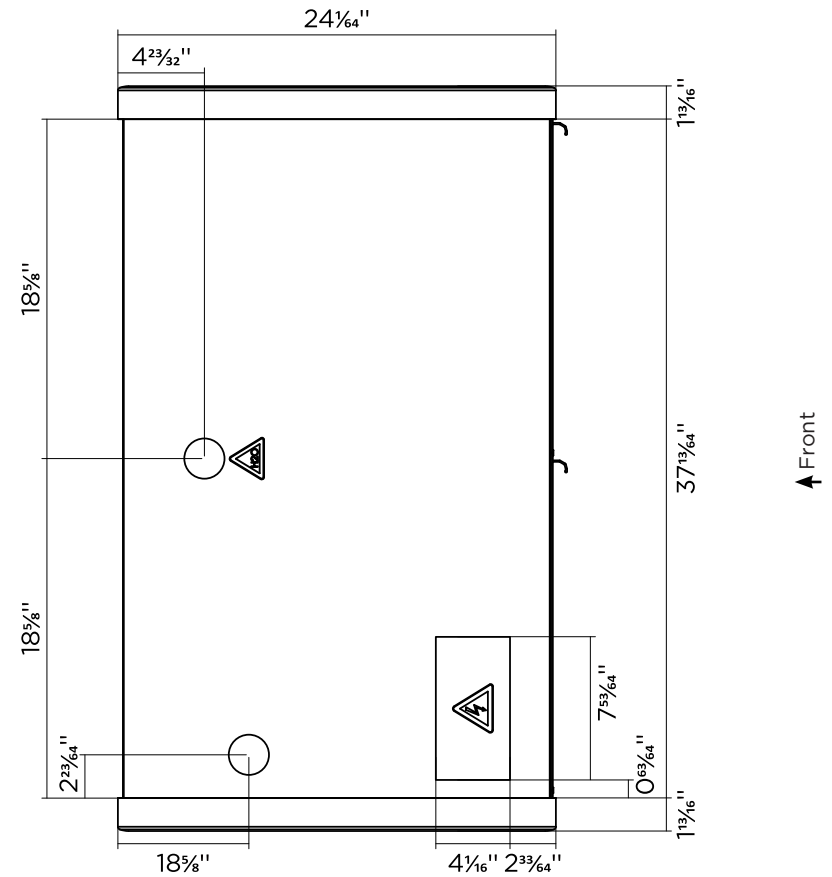

KGH-DS-40-R





N <sup>o</sup>	Discription
1	Compressor
2	Overload
3	Relay
4	Start capacitor
5	Condenser fan
6	Controller
7	Temperature probe
9	Terminal block
11	Ground connection
12	Evaporator fan
13	Compressor relay
20	Light switch
21	Pilot light
22	Switch
27	Run capacitor
29	Transformer
30	Led lighting
31	Socket
32	Evaporative condensate pan

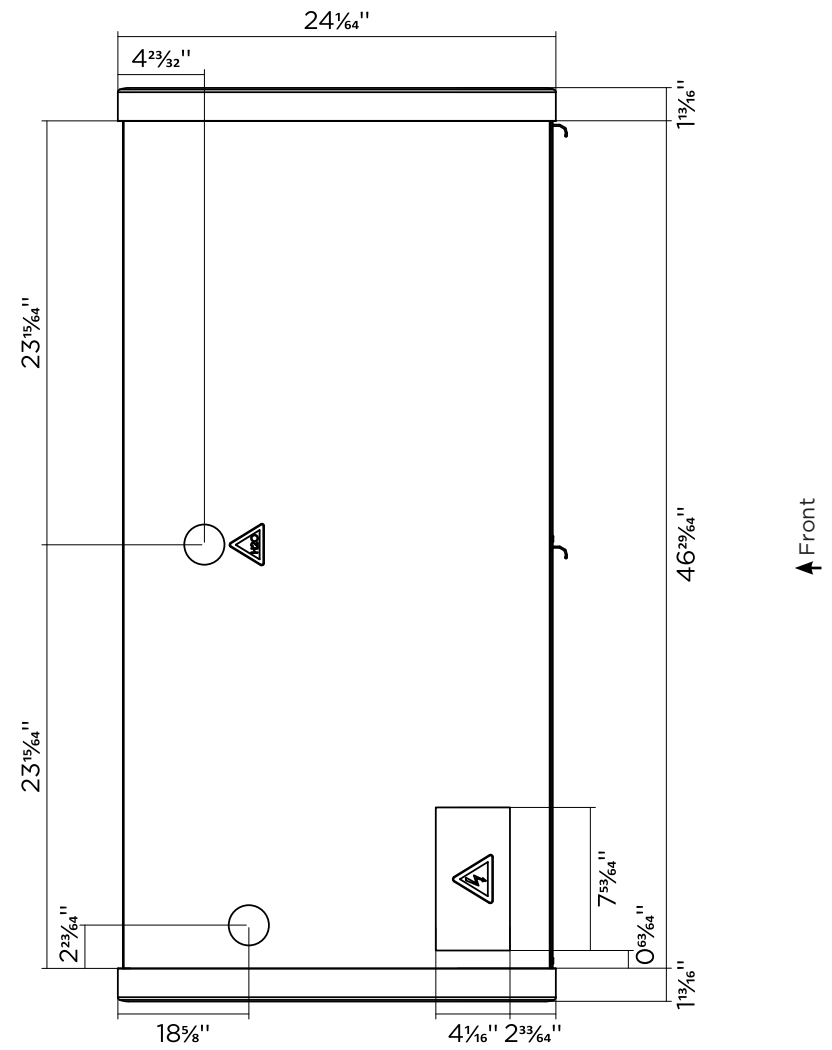

KGH-DS-50-R

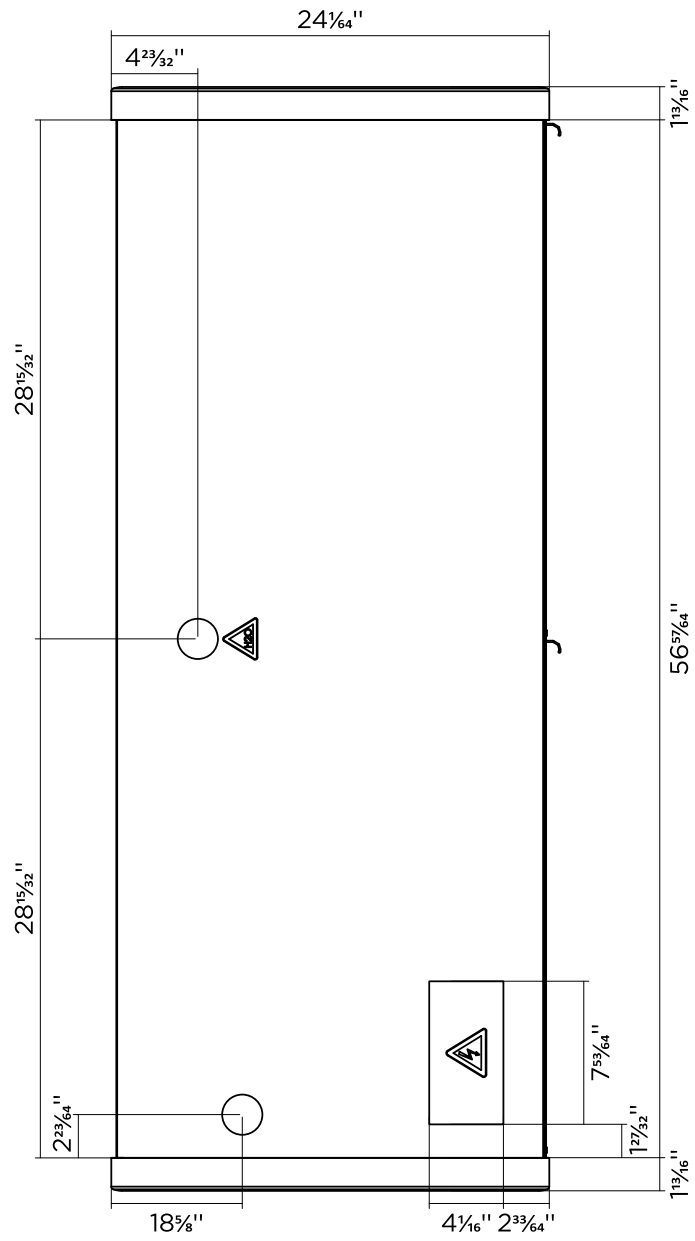

KGH-DS-60-S

↑ Front

KGH-OF-40/50-S

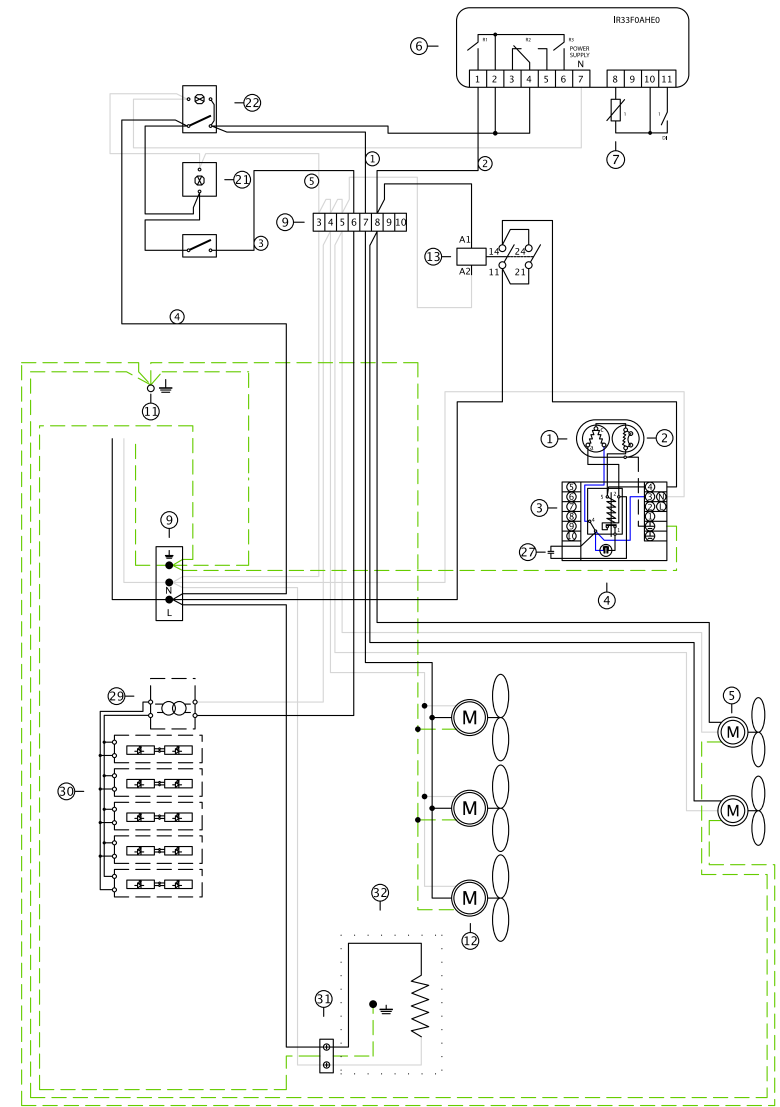

Nº	Description
1	Compressor
2	Overload
3	Relay
4	Start capacitor
5	Condenser fan
6	Controller
7	Temperature probe
9	Terminal block
11	Ground connection
12	Evaporator fan
13	Compressor relay
20	Light switch
21	Pilot light
22	Switch
27	Run capacitor
29	Transformer
30	Led lighting
31	Socket
32	Evaporative condensate pan

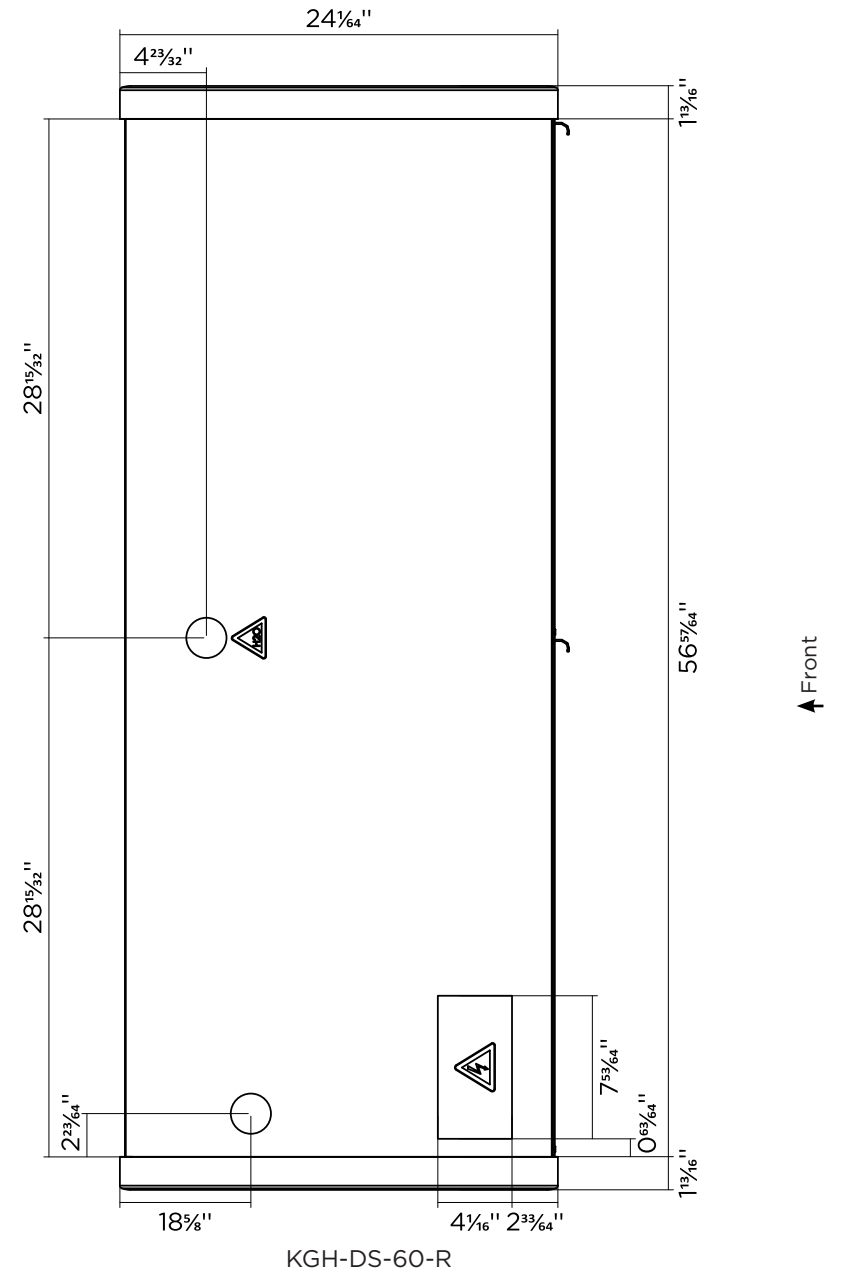



## 4.2. Electrical service receptacles (optional)

 Service receptacles are not intended nor suitable for large motors or other external appliances. Only for scales and lighted displays.

### Receptacle ampacity

Type	Max. amps
GFCI	xx

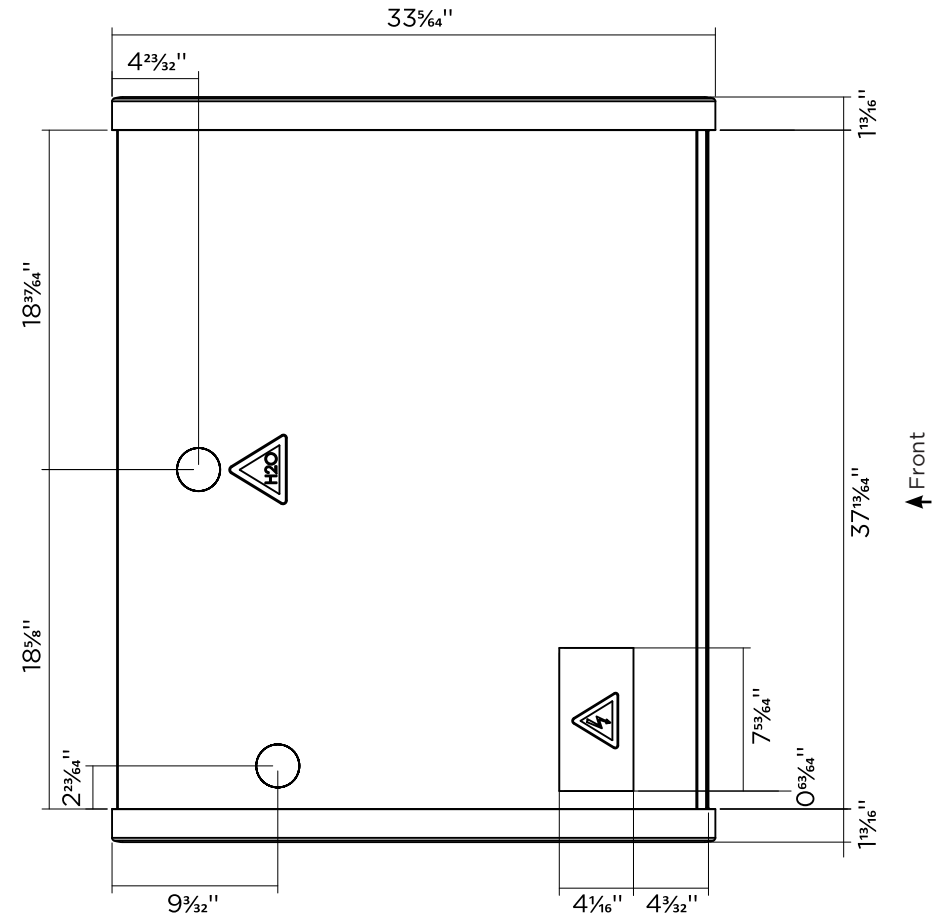

KGH-ES-40-R



## 4 Electrical

### 4.1. Electrical specifications data

 Electrical data can be found on the marking plate.

Standard equipment depending on the model type includes led lighting in all shelves and top, electrical shutter and anti sweat heaters.

115V/60Hz/1 phase

Model	Compressor F.L.A./L.R.A.	Lights	Fans		Evap pan	Electrical shutter	Total amps (self contained)
			EVP	CND			
KGH-OF/MS-30-S	16/64	0,15	0,70	0,55	3,33		20,73
KGH-OF/MS/OS-40-S	16,2/83	0,2	0,70	0,90	8,33		26,33
KGH-OF/MS/OS-50-S	16,2/83	0,25	1,05	1,1	8,33		26,93
KGH-OF/MS/OS-60-S							
KGH-OF/MS-80-S							
KGH-ES-30-S	16/64	0,15	0,70	0,55	3,33	1	20,73
KGH-ES-40-S	16,2/83	0,2	0,70	0,90	8,33	1	26,33
KGH-ES-50-S	16,2/83	0,25	1,05	1,1	8,33	1	26,93
KGH-ES-60-S							
KGH-ES-80-S							
KGH-FD/DS-40-S							
KGH-FD/DS-50-S							
KGH-FD/DS-60-S							
KGH-FD/DS-80-S							

The data regards to standard options only.

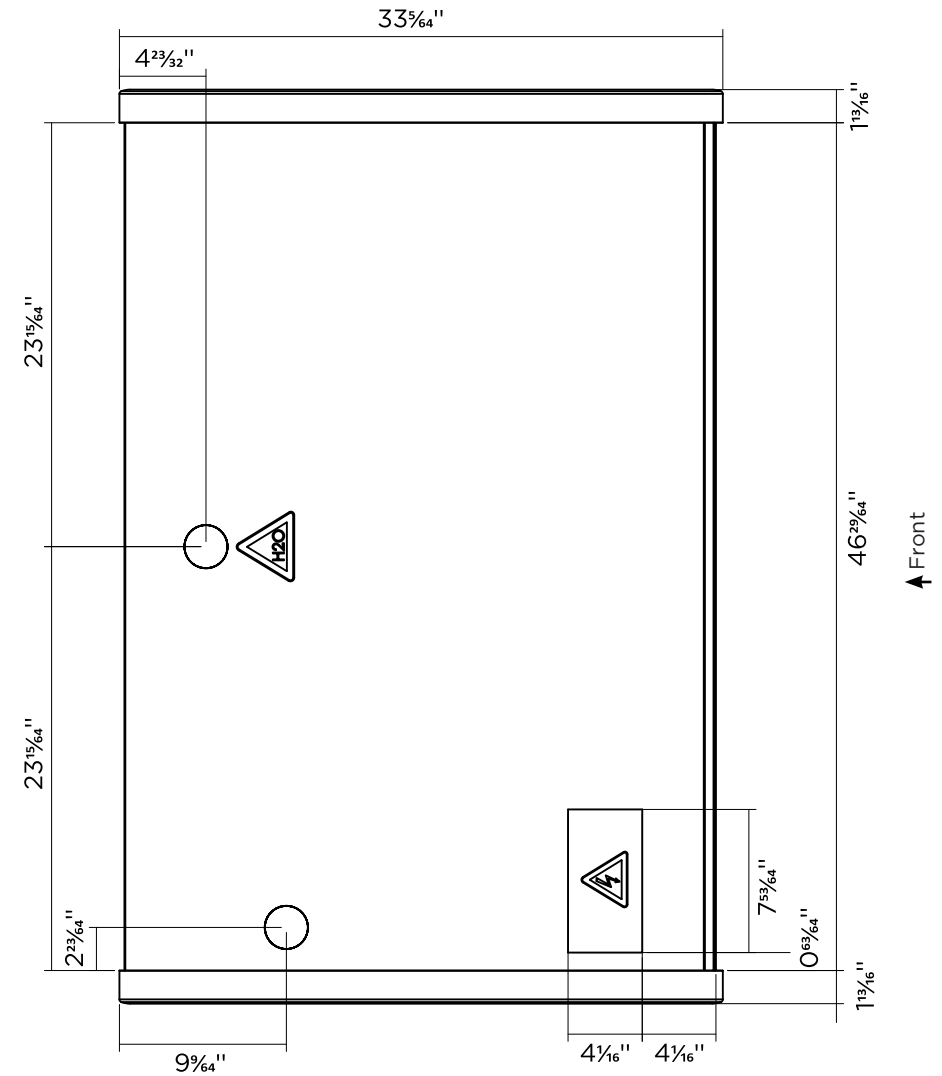

KGH-ES-50-R

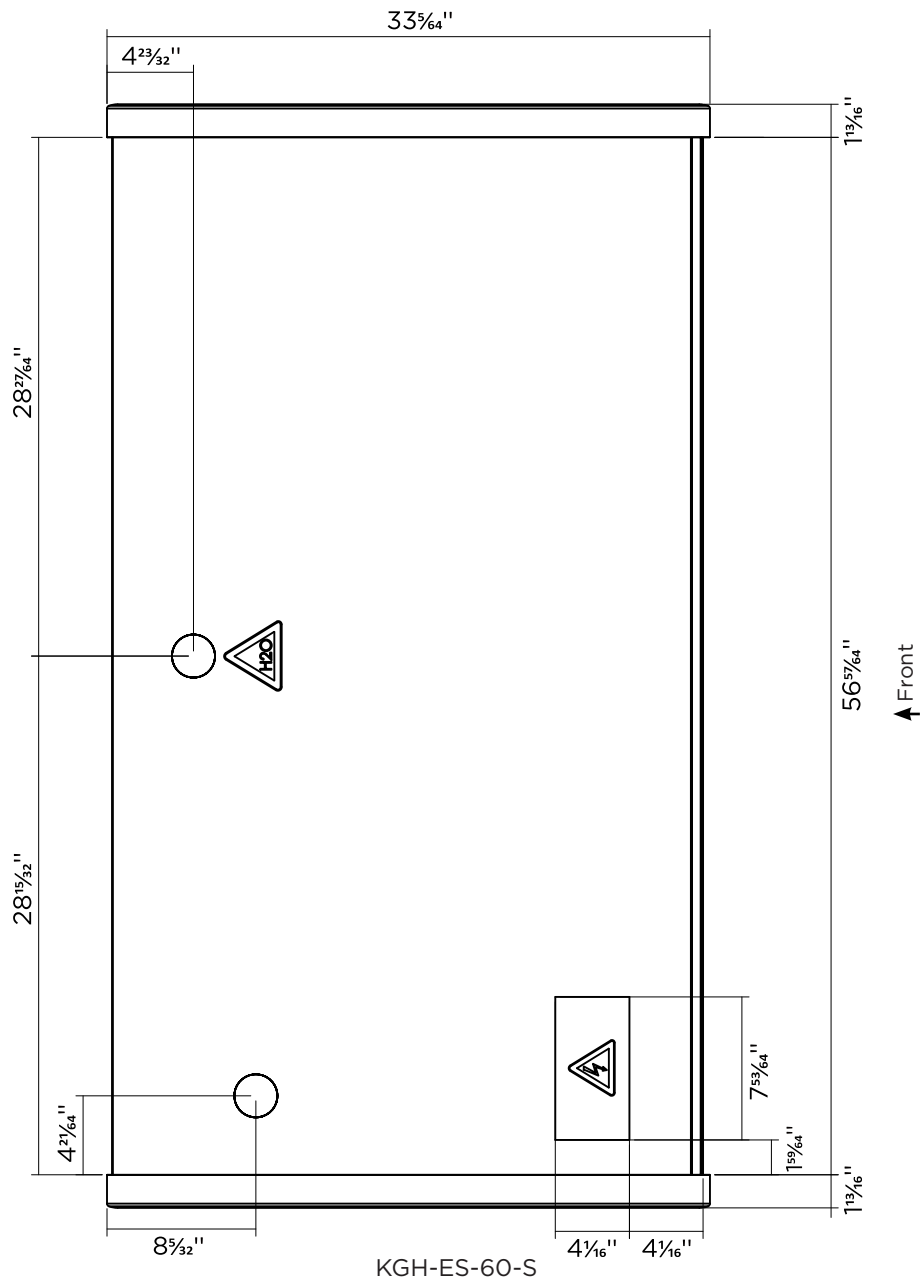

### 3.2 Refrigeration loads (remotes only)

 Installation of remote equipment must be done by a qualified technician

Model	BTU*/h	Expansion valve type	
KGH-OF/ES/MS-30-R	4793	TS2	00
KGH-OF/ES/MS-40-R	6940	TS2	00
KGH-OF/ES/MS-50-R	7565	TS2	00
KGH-OF/ES/MS-60-R	9383	TS2	00
KGH-OF/ES/MS-80-R	13881	TS2	00
KGH-FD-40-R	2615	TS2	00
KGH-FD-50-R	3425	TS2	00
KGH-FD-60-R	3582	TS2	00
KGH-FD-80-R	4479	TS2	00
KGH-OS-40-R	6246	TS2	00
KGH-OS-50-R	6794	TS2	00
KGH-OS-60-R	8435	TS2	00
KGH-DS-40-R	2615	TS2	00
KGH-DS-50-R	3425	TS2	00
KGH-DS-60-R	3582	TS2	00

\*values presented are indicative for 14°F evap, and 90°F ambient.



All self contained KGH series use the following equipment: capillary tube, finned coil ventilated systems (condenser/evaporator), hermetic compressor, electrical water evaporation system .

Model	Circuit pressure (psig)		Refrigerant and charge (OZ)	Defrost
	High side	Low side		
KGH-OF/ES/MS-30-S	331	174	R 404A xx	Automatic 4/day
KGH-OF/ES/MS-40-S	331	174	R 404A xx	Automatic 4/day
KGH-OF/ES/MS-50-S	331	174	R 404A xx	Automatic 4/day
KGH-OF/ES/MS-60-S	331	174	R 404A xx	Automatic 4/day
KGH-OF/ES/MS-80-S	331	174	R 404A xx	Automatic 4/day
KGH-FD-40-S	331	174	R 404A xx	Automatic 2/day
KGH-FD-50-S	331	174	R 404A xx	Automatic 2/day
KGH-FD-60-S	331	174	R 404A xx	Automatic 2/day
KGH-FD-80-S	331	174	R 404A xx	Automatic 2/day
KGH-OS-40-S	331	174	R 404A xx	Automatic 4/day
KGH-OS-50-S	331	174	R 404A xx	Automatic 4/day
KGH-OS-60-S	331	174	R 404A xx	Automatic 4/day
KGH-DS-40-S	331	174	R 404A xx	Automatic 2/day
KGH-DS-50-S	331	174	R 404A xx	Automatic 2/day
KGH-DS-60-S	331	174	R 404A xx	Automatic 2/day

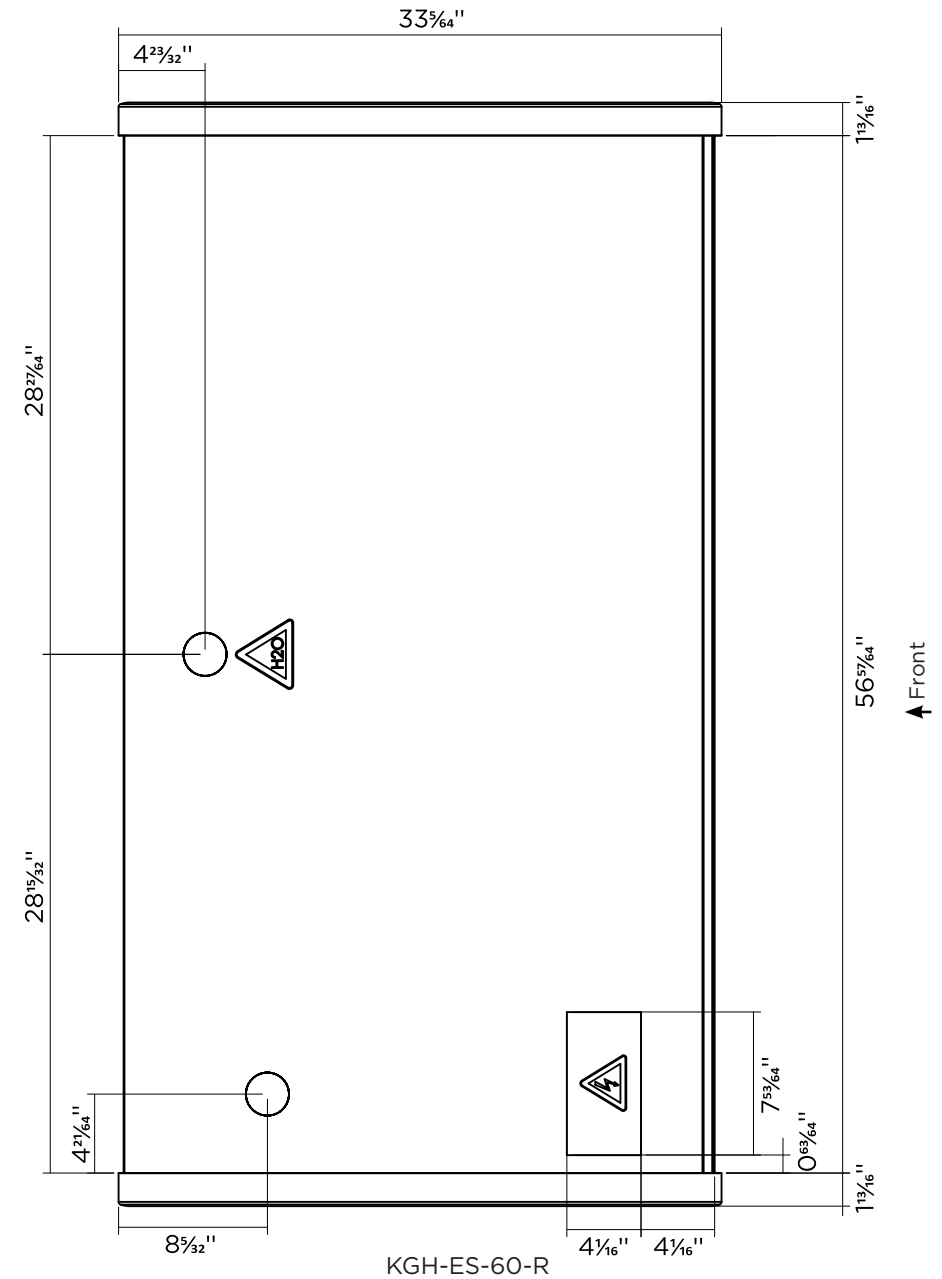

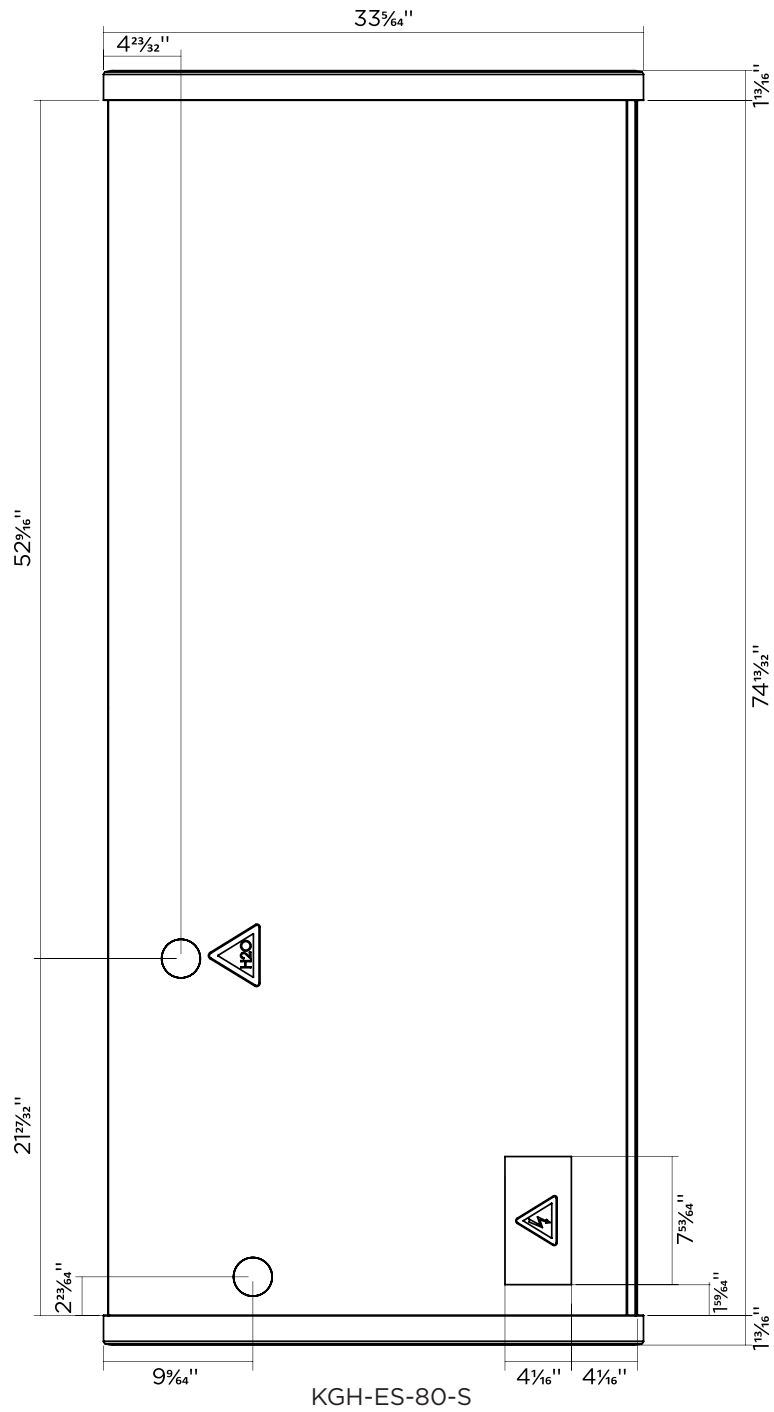

KGH-ES-80-S

↑ Front

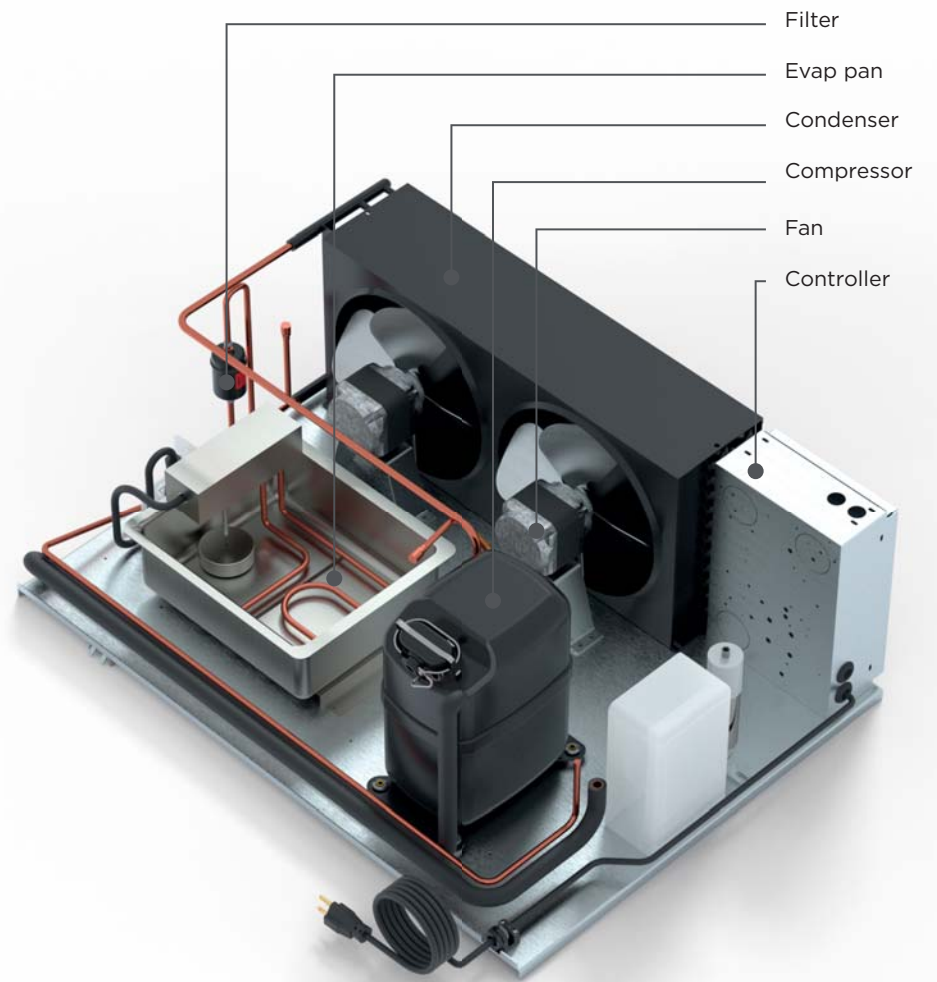

⚠ After loading check for any obstruction in the discharge and return air grilles.

⚠ Maintain doors closed after loading (KGH-FD/DS models only).

9 - If any problem encountered, see troubleshooting or call a qualified technician!

10- To fully disconnect the unit must pull the plug.

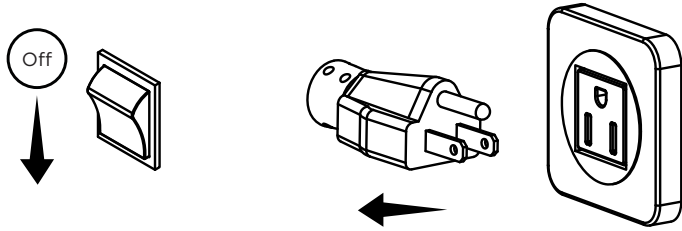



### 3 Refrigeration

#### 3.1 Self contained refrigeration equipment and defrost

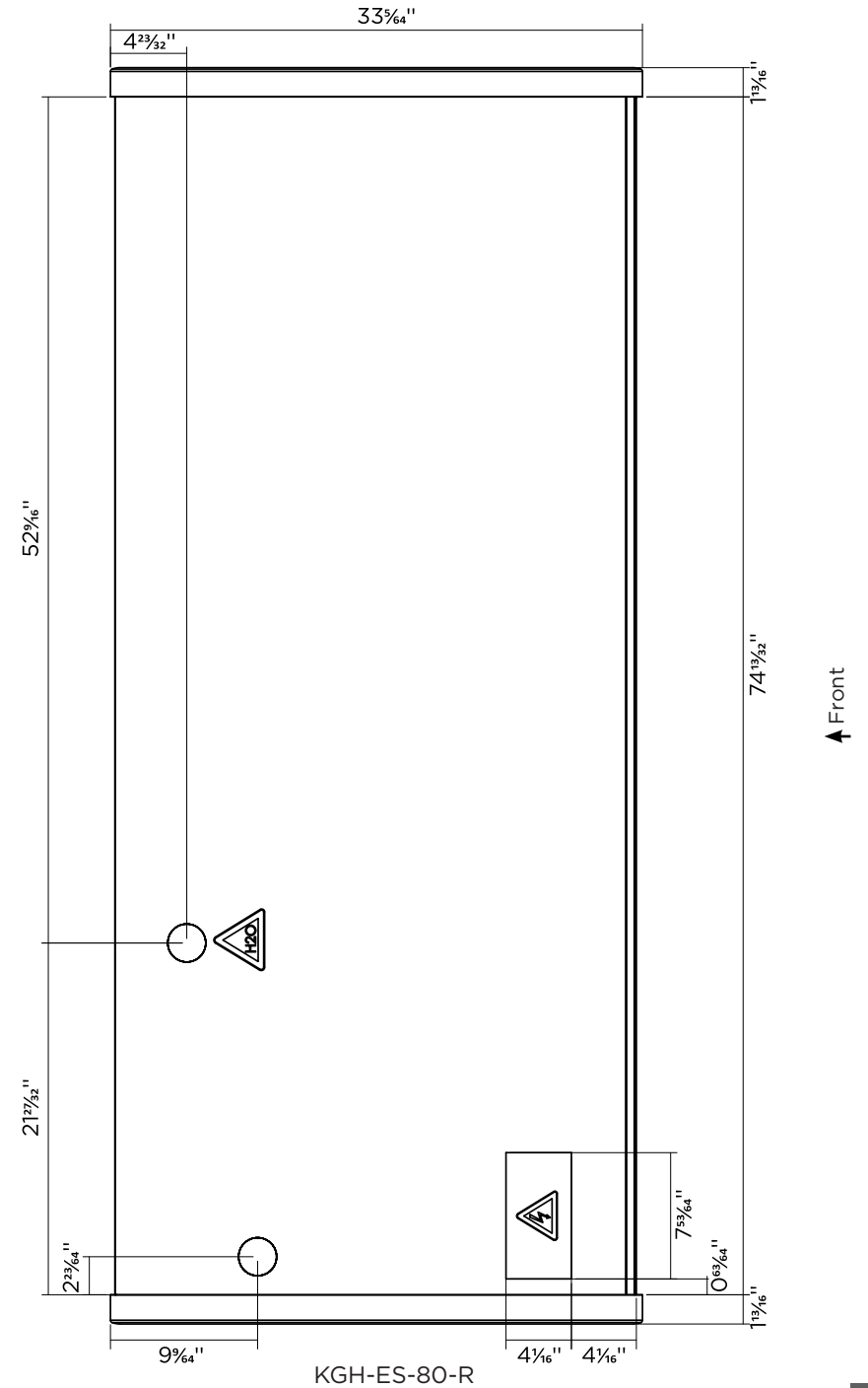
The refrigeration equipment it's laid out in the base of the equipment.



## Implantation

-  Drain outlet
-  Electrical board
-  Refrigeration piping

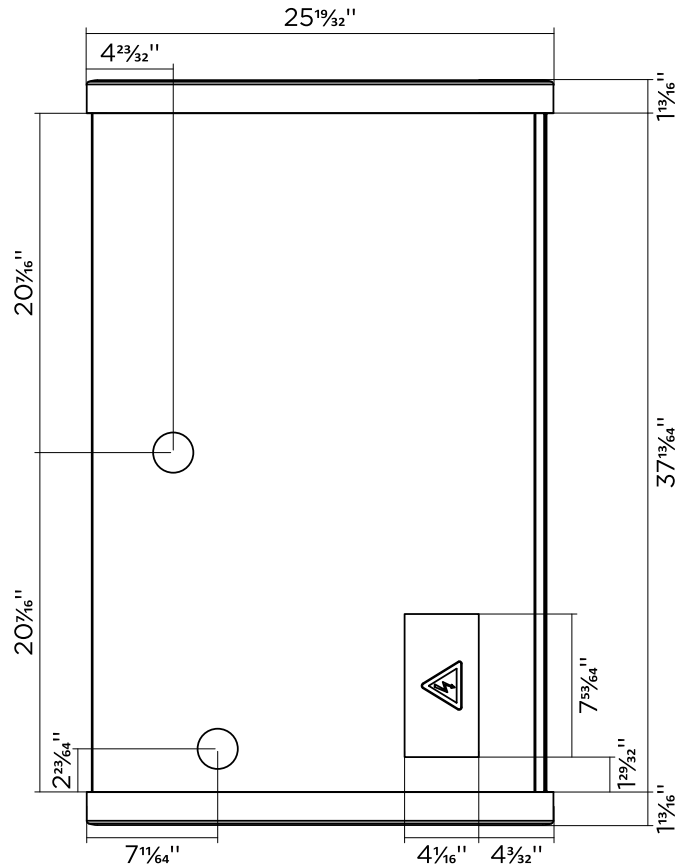

KGH-MS-40-S

6 - Check for air movement in the discharge grille.

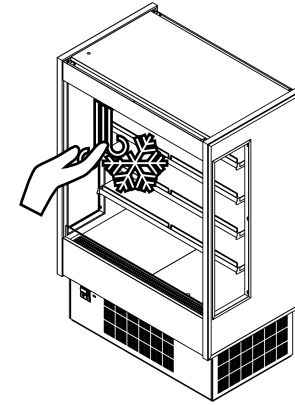

7 - Before loading, leave the equipment working for about 2h.

8 - Load your KGH-Series.



Loading must be done respecting loading limits and weight per square foot mentioned in page xx. This equipment is intended for maintaining temperature, be sure the products are cold, and not ambient temperature.



Volumes inside must respect the refrigerated shelf area.

↑ Front

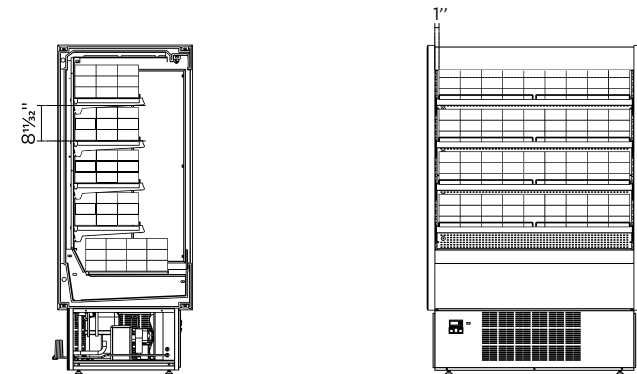

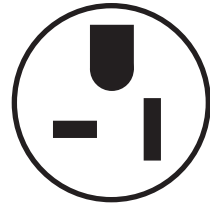
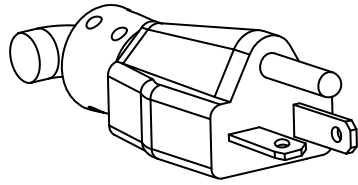



Nema-5-20P

3 - Check lights, using button referenced on chapter 2.4. If not working consult the maintenance chapter. KGH-OF/FD/OS/MS only.

3.1 - For KGH-ES, lights and shutter are controlled by key referenced on 2.4 chapter. Turn the key to check lights and shutter. (Open shutter = lights ON)

 Open or close shutter only when needed to prevent motor burning.

4 - Check for shutter normal operation.

 Keep shutter rails clear for proper operation.

Turn the key to control the shutter.

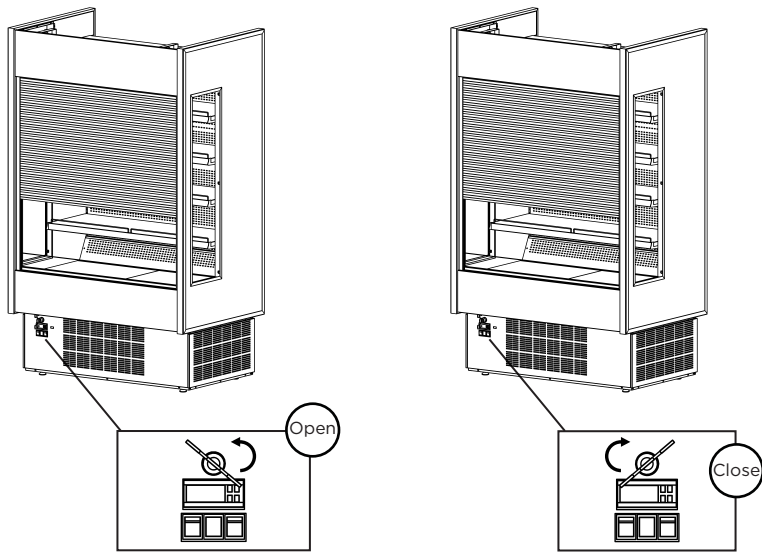

5 - Turn ON power button referenced in 2.6 chapter.

 Noise will be heard when compressor starts! If compressor doesn't start, call a technician!

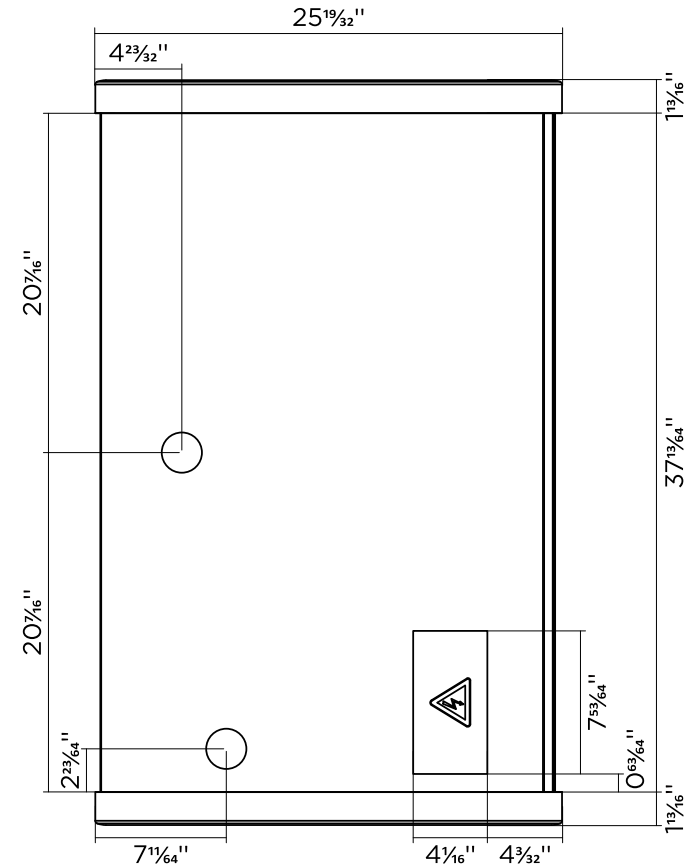

↑ Front

KGH-MS-40-R

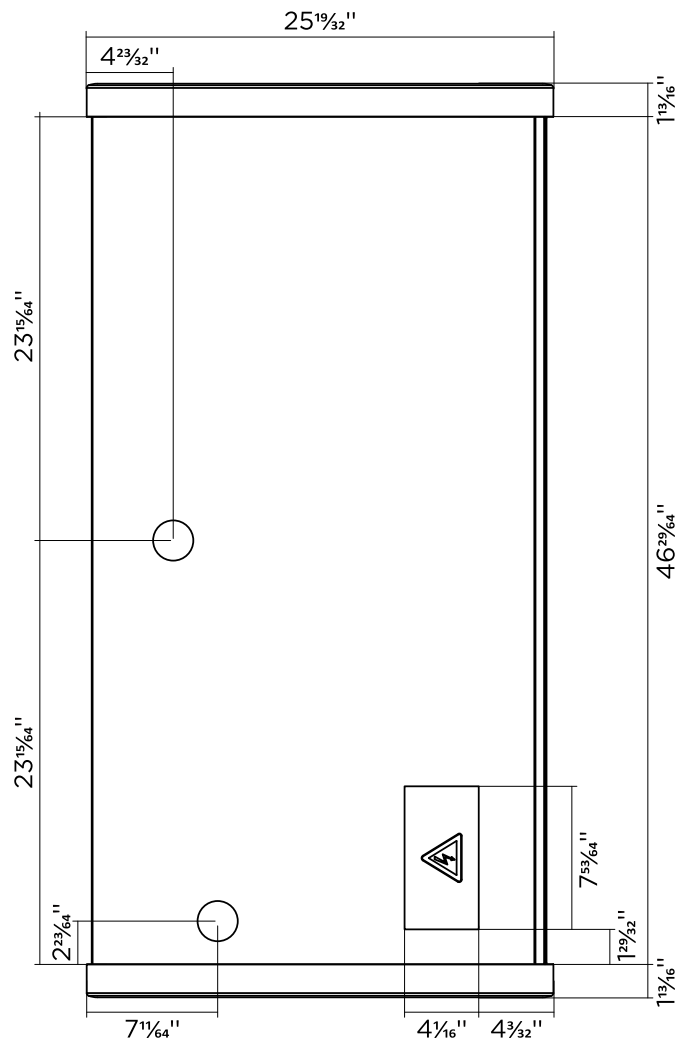

KGH-MS-50-S

↑ Front

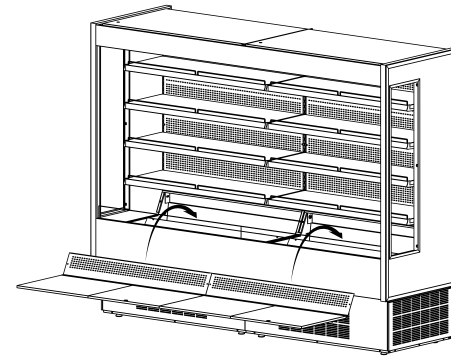
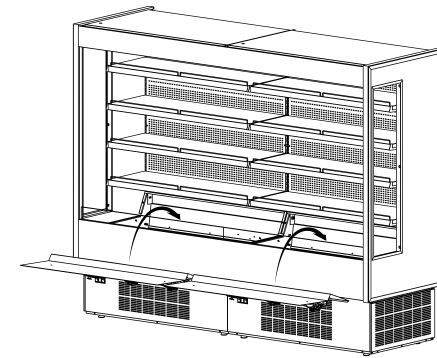

## 2.10 Plugging and start

To start your equipment follow the steps:

- 1 - Check for page with parameters inside the manual.
- 2 - After uncrating and placed the equipment respecting all warnings set in 2.1 chapter, and all switches are set to off position, connect the equipment.

 Make sure you have the correct outlet!

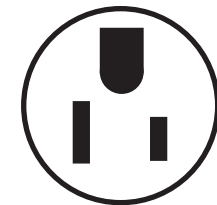
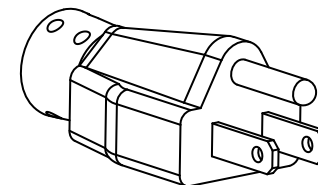

Nema-5-15P

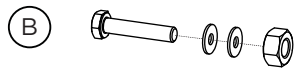
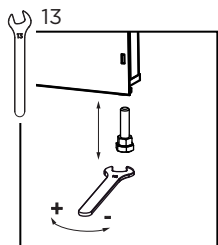
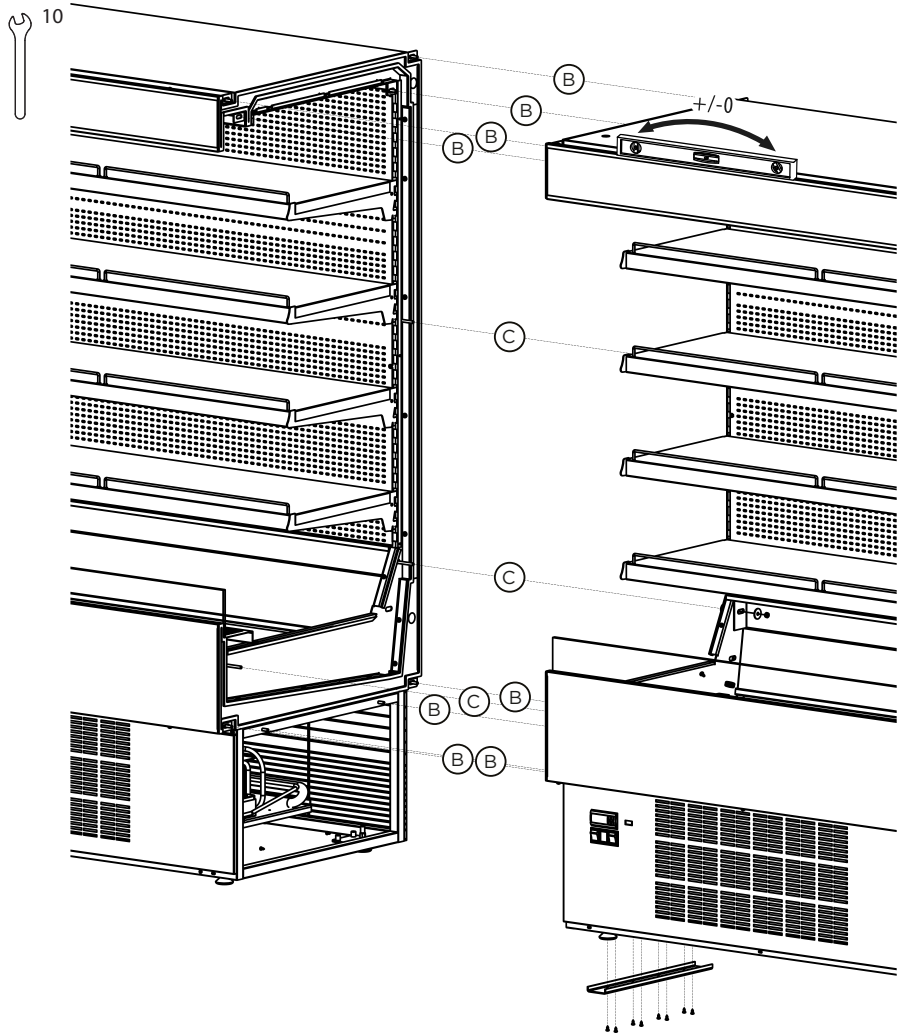

- 1x - DIN933 M6x20
- 2x - DIN9021 M6
- 1x - DIN934 M6



- 1x - DIN933 M6x80
- 2x - DIN9021 M6
- 1x - DIN934 M6

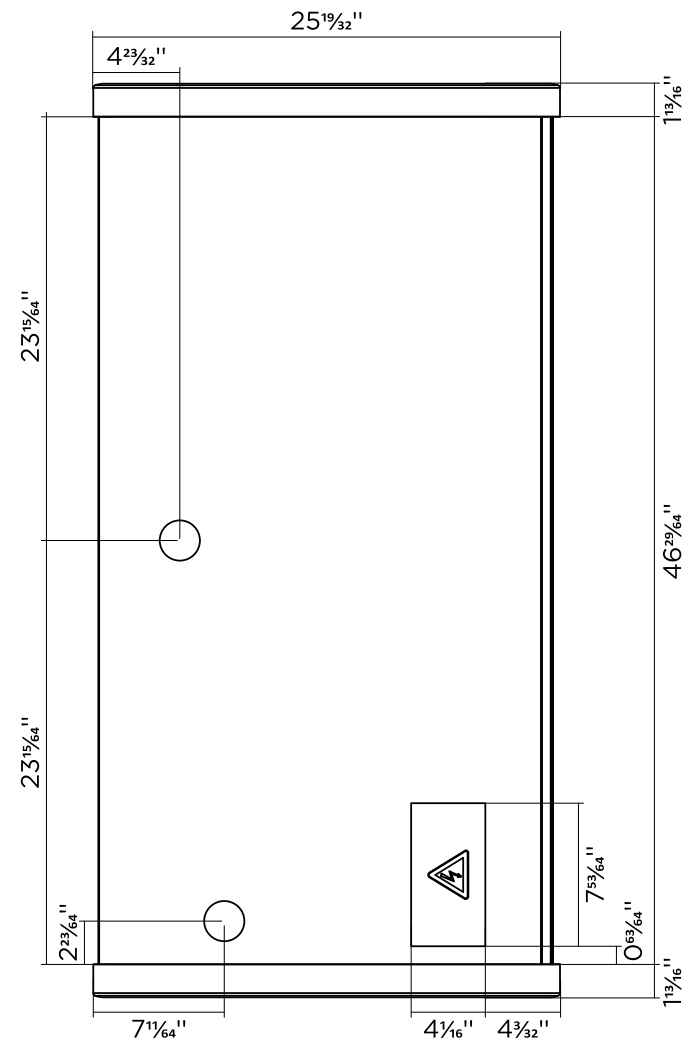

↑ Front

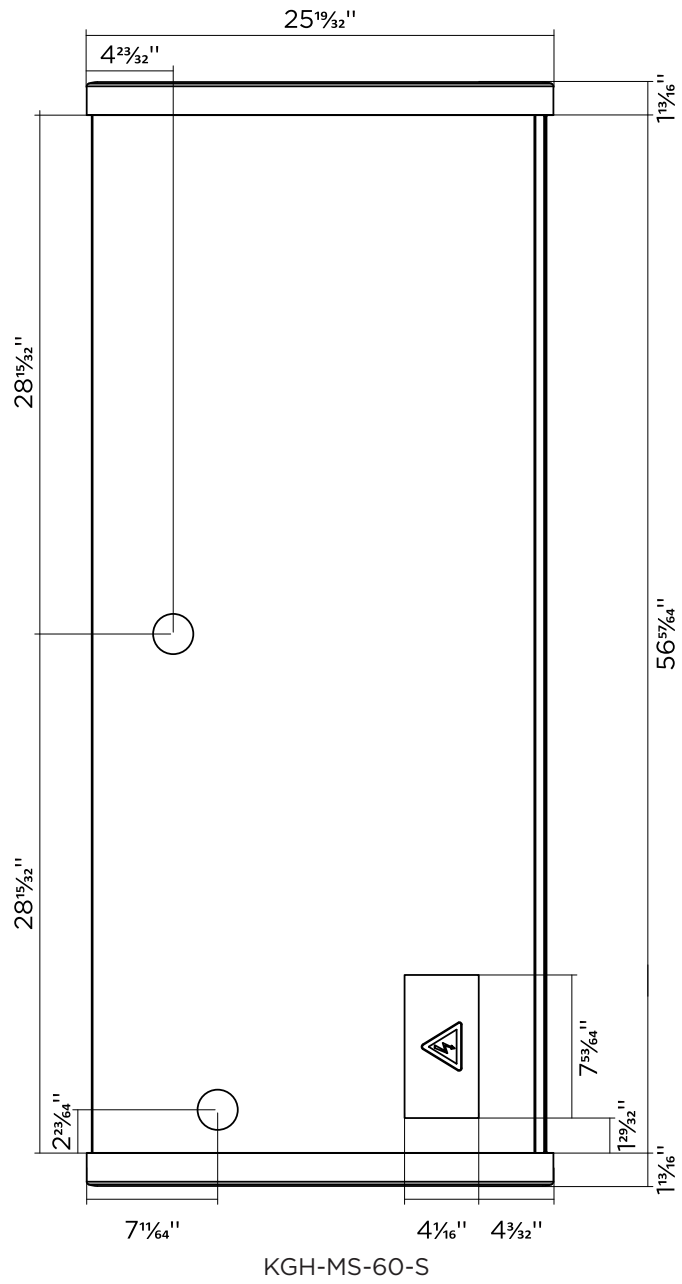

↑ Front

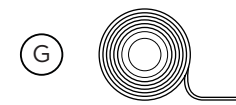
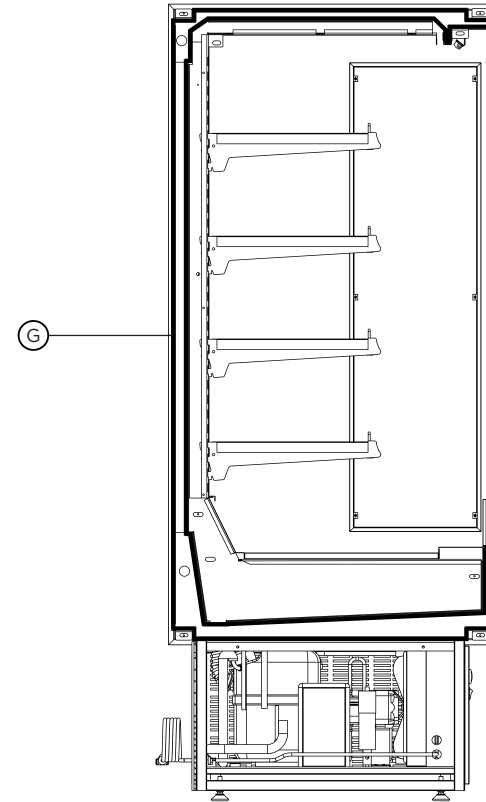

2X - FIT00000427 (91<sup>49</sup>/<sub>64</sub>" )



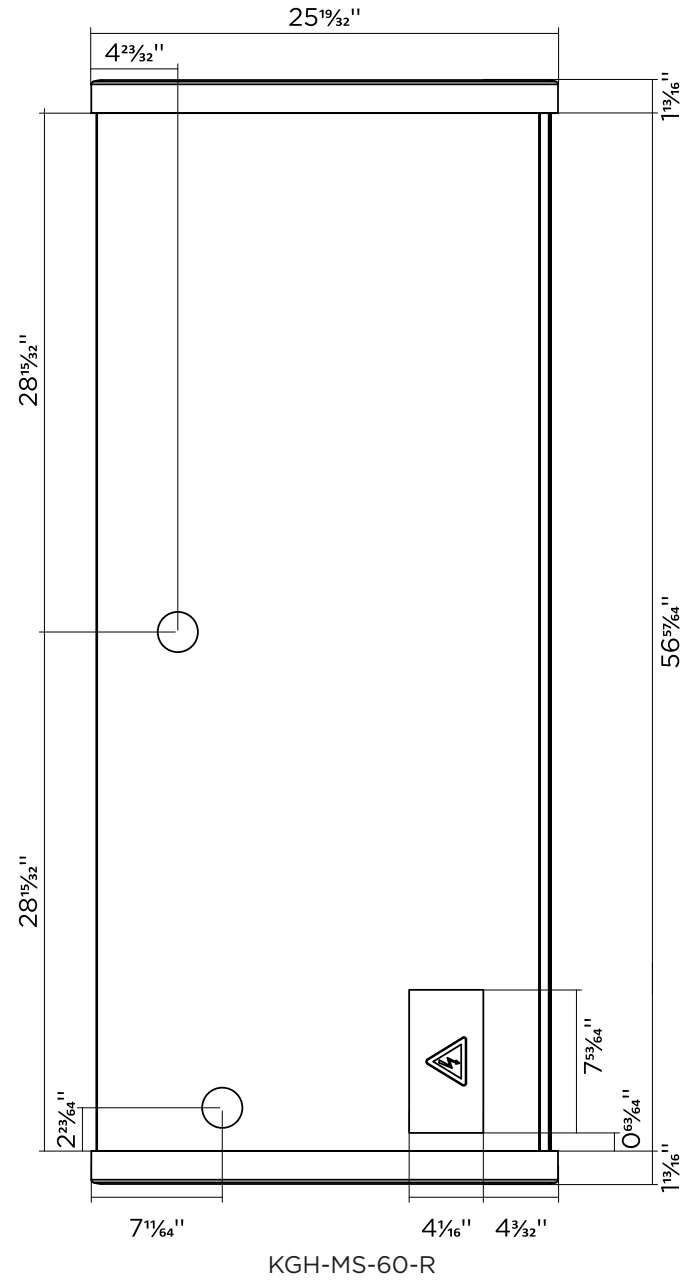
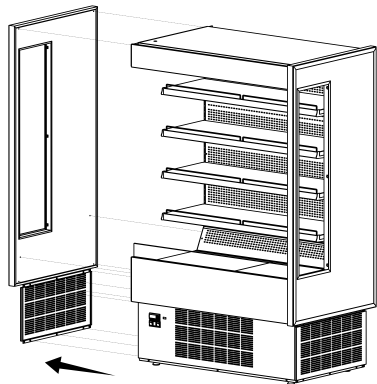
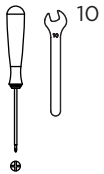
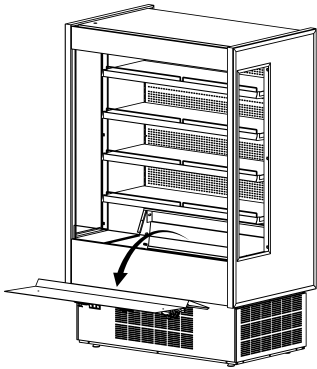
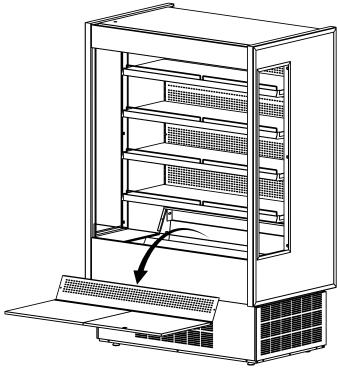

KGH series intended for multipurpose are type 1 equipment - 75°F/55%RH.  
 Temperature for open front cases is set for 36°F.  
 Temperature for door cases is set for 32°F.  
 The shelves have a 31 lb/ft2 loading limit.

Model	Dimensions (LxDxH in inches)	Service dimensions (LxDxH in inches)	Volume (ft <sup>3</sup> )
KGH-OF-30-S(R)	28 <sup>15</sup> / <sub>16</sub> " x 31 <sup>1</sup> / <sub>2</sub> " x 76 <sup>7</sup> / <sub>8</sub> "	28 <sup>15</sup> / <sub>16</sub> " x 43 <sup>9</sup> / <sub>16</sub> " x 76 <sup>7</sup> / <sub>8</sub> "	15,9
KGH-OF-40-S(R)	40 <sup>13</sup> / <sub>16</sub> " x 31 <sup>1</sup> / <sub>2</sub> " x 76 <sup>7</sup> / <sub>8</sub> "	40 <sup>13</sup> / <sub>16</sub> " x 43 <sup>9</sup> / <sub>16</sub> " x 76 <sup>7</sup> / <sub>8</sub> "	23,3
KGH-OF-50-S(R)	50 <sup>1</sup> / <sub>16</sub> " x 31 <sup>1</sup> / <sub>2</sub> " x 76 <sup>7</sup> / <sub>8</sub> "	50 <sup>1</sup> / <sub>16</sub> " x 43 <sup>9</sup> / <sub>16</sub> " x 76 <sup>7</sup> / <sub>8</sub> "	29,1
KGH-OF-60-S(R)	60 <sup>1</sup> / <sub>2</sub> " x 31 <sup>1</sup> / <sub>2</sub> " x 76 <sup>7</sup> / <sub>8</sub> "	60 <sup>1</sup> / <sub>2</sub> " x 43 <sup>9</sup> / <sub>16</sub> " x 76 <sup>7</sup> / <sub>8</sub> "	35,6
KGH-OF-80-S(R)	78" x 31 <sup>1</sup> / <sub>2</sub> " x 76 <sup>7</sup> / <sub>8</sub> "	78" x 43 <sup>9</sup> / <sub>16</sub> " x 76 <sup>7</sup> / <sub>8</sub> "	46,6
KGH-FD-40-S(R)	40 <sup>13</sup> / <sub>16</sub> " x 32 <sup>1</sup> / <sub>8</sub> " x 76 <sup>7</sup> / <sub>8</sub> "	40 <sup>13</sup> / <sub>16</sub> " x 51 <sup>1</sup> / <sub>16</sub> " x 76 <sup>7</sup> / <sub>8</sub> "	23,2
KGH-FD-50-S(R)	50 <sup>1</sup> / <sub>16</sub> " x 32 <sup>1</sup> / <sub>8</sub> " x 76 <sup>7</sup> / <sub>8</sub> "	50 <sup>1</sup> / <sub>16</sub> " x 56 <sup>3</sup> / <sub>16</sub> " x 76 <sup>7</sup> / <sub>8</sub> "	29
KGH-FD-60-S(R)	60 <sup>1</sup> / <sub>2</sub> " x 32 <sup>1</sup> / <sub>8</sub> " x 76 <sup>7</sup> / <sub>8</sub> "	60 <sup>1</sup> / <sub>2</sub> " x 52" x 76 <sup>7</sup> / <sub>8</sub> "	35,6
KGH-FD-80-S(R)	78" x 32 <sup>1</sup> / <sub>8</sub> " x 76 <sup>7</sup> / <sub>8</sub> "	78" x 57 <sup>13</sup> / <sub>16</sub> " x 76 <sup>7</sup> / <sub>8</sub> "	45,5
KGH-OS-40-S(R)	40 <sup>13</sup> / <sub>16</sub> " x 24" x 76 <sup>7</sup> / <sub>8</sub> "	40 <sup>13</sup> / <sub>16</sub> " x 33 <sup>3</sup> / <sub>8</sub> " x 76 <sup>7</sup> / <sub>8</sub> "	15,3
KGH-OS-50-S(R)	50 <sup>1</sup> / <sub>16</sub> " x 24" x 76 <sup>7</sup> / <sub>8</sub> "	50 <sup>1</sup> / <sub>16</sub> " x 33 <sup>3</sup> / <sub>8</sub> " x 76 <sup>7</sup> / <sub>8</sub> "	19,0
KGH-OS-60-S(R)	60 <sup>1</sup> / <sub>2</sub> " x 24" x 76 <sup>7</sup> / <sub>8</sub> "	60 <sup>1</sup> / <sub>2</sub> " x 33 <sup>3</sup> / <sub>8</sub> " x 76 <sup>7</sup> / <sub>8</sub> "	23,3
KGH-DS-40-S(R)	40 <sup>13</sup> / <sub>16</sub> " x 24 <sup>5</sup> / <sub>8</sub> " x 76 <sup>7</sup> / <sub>8</sub> "	40 <sup>13</sup> / <sub>16</sub> " x 51 <sup>1</sup> / <sub>16</sub> " x 76 <sup>7</sup> / <sub>8</sub> "	15,3
KGH-DS-50-S(R)	50 <sup>1</sup> / <sub>16</sub> " x 24 <sup>5</sup> / <sub>8</sub> " x 76 <sup>7</sup> / <sub>8</sub> "	50 <sup>1</sup> / <sub>16</sub> " x 56 <sup>3</sup> / <sub>16</sub> " x 76 <sup>7</sup> / <sub>8</sub> "	19,1
KGH-DS-60-S(R)	60 <sup>1</sup> / <sub>2</sub> " x 24 <sup>5</sup> / <sub>8</sub> " x 76 <sup>7</sup> / <sub>8</sub> "	60 <sup>1</sup> / <sub>2</sub> " x 52" x 76 <sup>7</sup> / <sub>8</sub> "	23,4
KGH-ES/MS-40-S(R)	40 <sup>13</sup> / <sub>16</sub> " x 33 <sup>1</sup> / <sub>16</sub> " x 82 <sup>9</sup> / <sub>16</sub> "	40 <sup>13</sup> / <sub>16</sub> " x 44 <sup>7</sup> / <sub>16</sub> " x 82 <sup>9</sup> / <sub>16</sub> "	23,3
KGH-ES/MS-50-S(R)	50 <sup>1</sup> / <sub>16</sub> " x 33 <sup>1</sup> / <sub>16</sub> " x 82 <sup>9</sup> / <sub>16</sub> "	50 <sup>1</sup> / <sub>16</sub> " x 44 <sup>7</sup> / <sub>16</sub> " x 82 <sup>9</sup> / <sub>16</sub> "	29,1
KGH-ES/MS-60-S(R)	60 <sup>1</sup> / <sub>2</sub> " x 33 <sup>1</sup> / <sub>16</sub> " x 82 <sup>9</sup> / <sub>16</sub> "	60 <sup>1</sup> / <sub>2</sub> " x 44 <sup>7</sup> / <sub>16</sub> " x 82 <sup>9</sup> / <sub>16</sub> "	35,6
KGH-ES/MS-80-S(R)	78" x 33 <sup>1</sup> / <sub>16</sub> " x 82 <sup>9</sup> / <sub>16</sub> "	78" x 44 <sup>7</sup> / <sub>16</sub> " x 82 <sup>9</sup> / <sub>16</sub> "	46,6

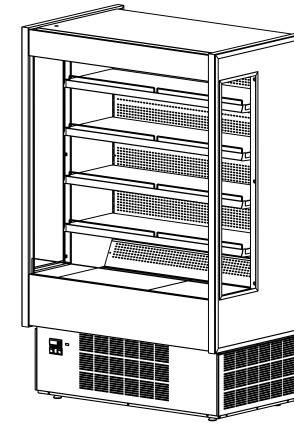

2x KGH-OF

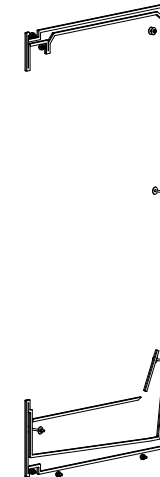

KIT0001U01000

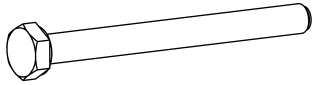

3x - PAR00601011 DIN933 M6x65

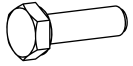

8x - PAR00601007 DIN933 M6x20

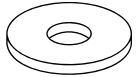

14x- ANL00501006 DIN9021 M6



11x - PRC00101006 DIN934 M6

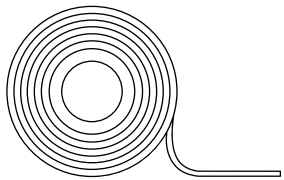

2X FIT00000316 A100 O4 (298½")

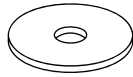

8x - ANL00601002

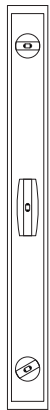

1x

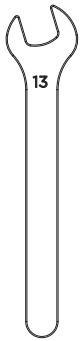

1x



1x

















1x



## 2 Getting started with your KGH series

### 2.1 Location

To your new equipment perform well please respect the following warnings:

-  This is type 1 equipment, intended to work with 75°F / 55%RH.
-  This equipment is intended for maintaining temperature only.
-  Be sure products are not ambient temperature (must be cold)
-  This equipment must be located in an indoor environment.
-  Check for drafts and avoid them.
-  Air movement from ac units shouldn't be directed to the equipment.
-  The equipment must not be directly or indirectly exposed to the sun.
-  Check for rejected heat from another refrigeration units and avoid that.
-  Place the equipment in a levelled floor.
-  Do not obstruct the air way in front of the condenser.
-  Make sure there is a drain preparation (Remotes only).
-  Models to be positioned against a wall keep a safe distance of 2<sup>3</sup>/<sub>8</sub>".
-  After servicing always close the doors.
-  Make sure you have a suitable electrical installation.
-  This equipment should be handled by a qualified technician.

### 2.2 Uncrating

-  All operations must be done carefully.
-  All plastic protective films must be removed before using the equipment for the first time.

1

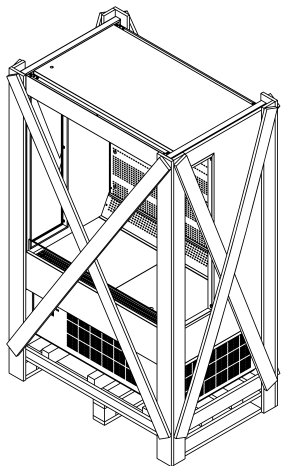

2

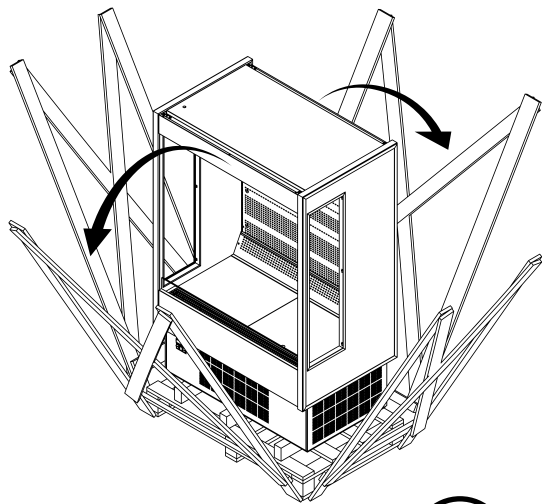

4

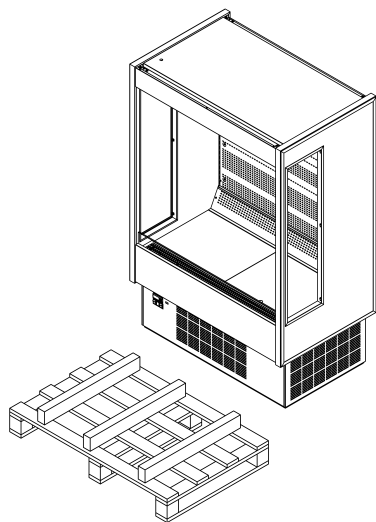

3

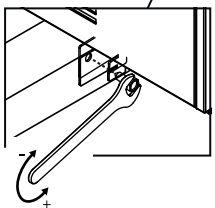
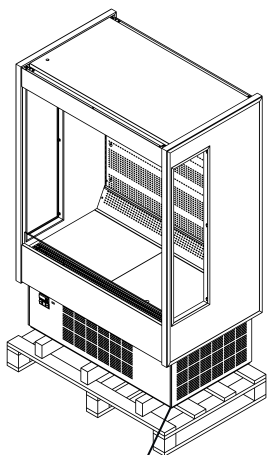

### 2.9 Joining

For joining follow the steps described.

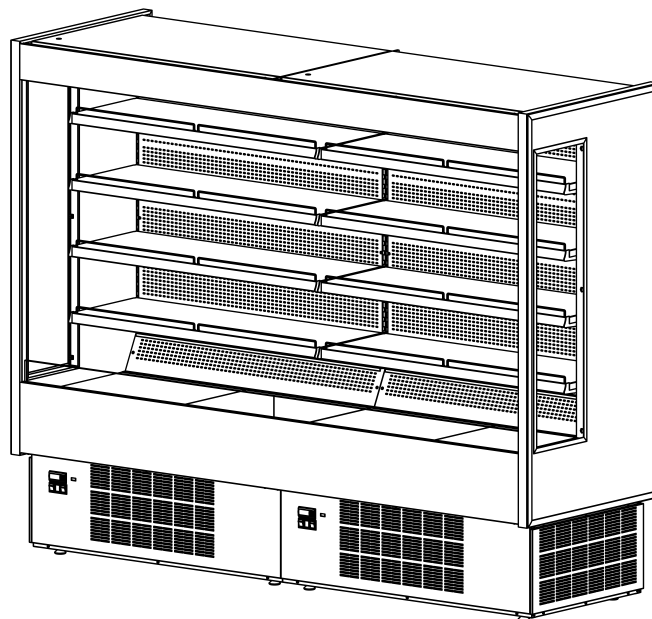

## 2.7 Check your electrical installation

- ⚠ This equipment can be connected to an outlet with 115V/ 60Hz/ 1 phase or 220V/ 60Hz/ 1 phase.
- ⚠ For the wright connection check tension and frequency stated in the marking plate.



Nema-5-15P

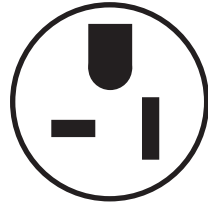

Nema-5-20P

## 2.8 Electrical, drain and refrigeration connections (remotes only)

- ⚠ Installation and service must be performed by a qualified technician.

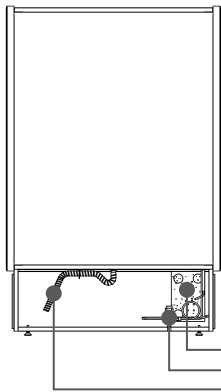

All electrical connections must be done from the electrical board  
Equipments for remote installation come with nitrogen under pressure and an easy prep kit (tubing connections needed only) for installation.  
Prepare a drain installation

## 2.2.1 Shelf and product stopper assembly

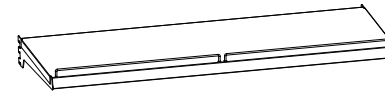

4x - PRT01M04130

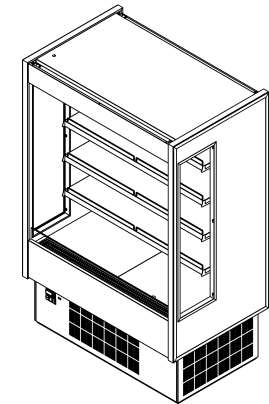
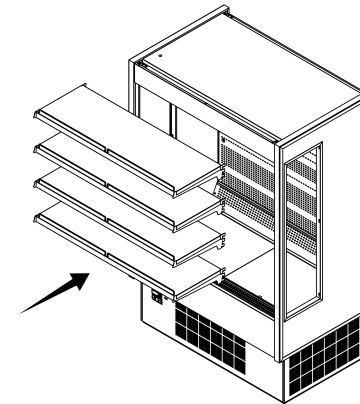

## 2.3 Check for damage

At the end of production HYDRA KOOL products are carefully inspected. No damaged units are sent out.  
HYDRA KOOL doesn't take responsibility for damage between factory and client.

Possible damage on the unit must be checked to file a claim near the transportation company.

The unit must be checked in the following points:

- Exterior panels
- Doors
- Shelves
- Glasses
- Paint job
- Door handles
- Top structure

## 2.4 Control panel and main features

The pictures below, shows the main features and all necessary controls

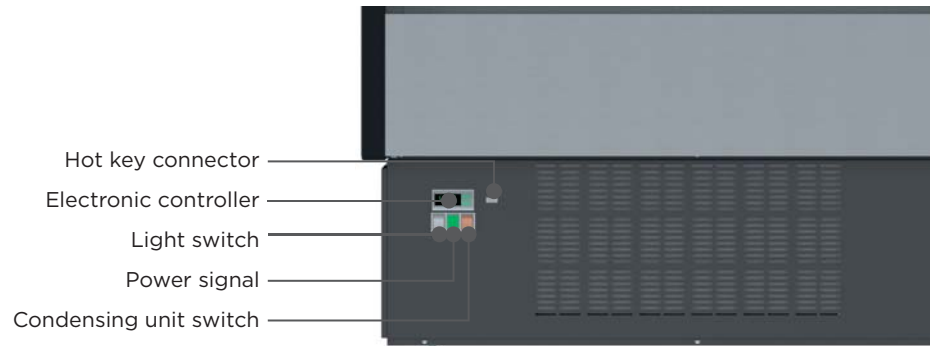

Self contained control panel  
(KGGH-OF/FD/OS/DS/MS)

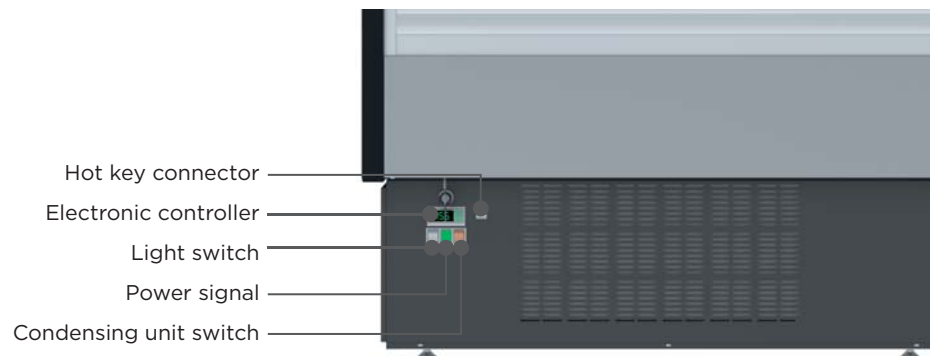

Label 9

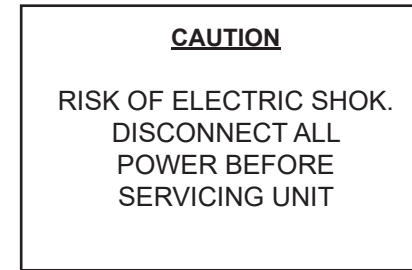

Label 10

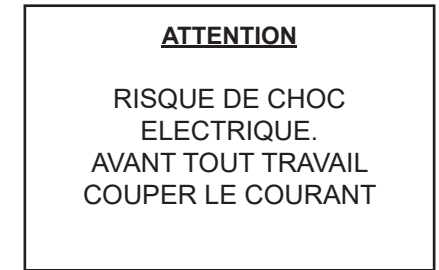

Label 11

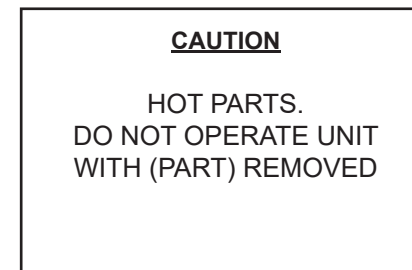

Label 12

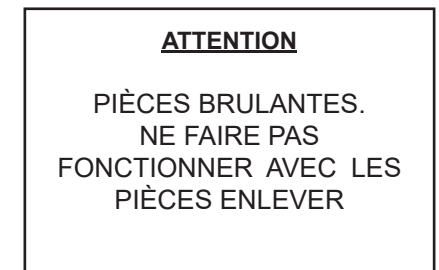

Label 13

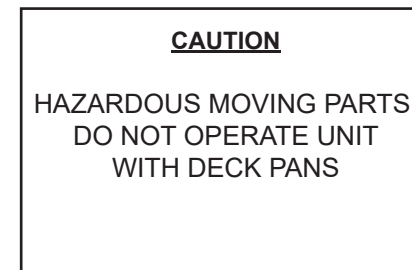

Label 14

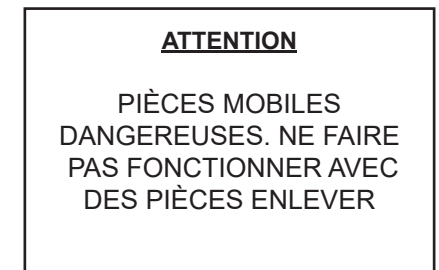

Label 15

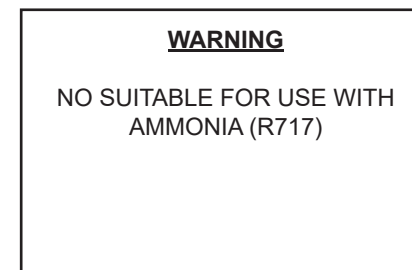

Label 16

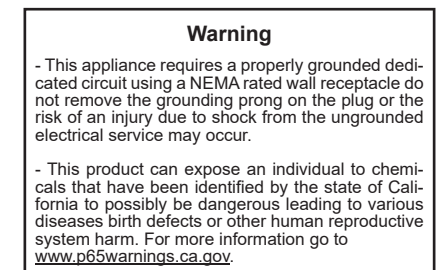

Label 1

**CAUTION**

MOVING PARTS.  
DO NOT OPERATE UNIT  
WITH (PART) REMOVED

Label 2

**ATTENTION**

PIÈCES MOBILES.  
NE FAIRE PAS  
FONCTIONNER AVEC  
DES PIÈCES ENLEVER

Label 3

**-NOTE-**

TYPE 1 EQUIPMENT - AMBIENT  
LOCATION MUST NOT EXCEED 75  
F AND 55% R.H.

Label 4

**-NOTE-**

CETTE VITRINE TYPE 1 EST  
CONÇUE POUR FONCTION-  
NER SELON LES CONDITIONS  
DU MAGASIN ET NE DOIT  
DÉPASSER  
75 F AND 55% R.H.

Label 5

**CAUTION**

CONDENSING UNIT SWITCH ONLY

Label 6

**ATTENTION**

INTERRUPTEUR DE L'UNITÉ DE  
CONDENSATION UNIQUEMENT

Label 7

**CAUTION**

FOR THE SHUTTER CORRECT  
OPENING AND CLOSING OPER-  
ATION, IT IS MANDATORY FOR  
ALL THE SHUTTER RAILS TO BE  
CLEAR AND UNOBSTRUCTED

Label 8

**ATTENTION**

POUR OUVERTURE ET FERME-  
TURE CORRECTE DU VOLET  
ROULANT, IL EST OBLIGATOIRE  
POUR TOUTES LES COULISSES  
DU VOLET ROULANT D'ETRE DE-  
GAGEES ET DEBARRASSEES



Electrical board

Self contained control panel (KGH-ES)

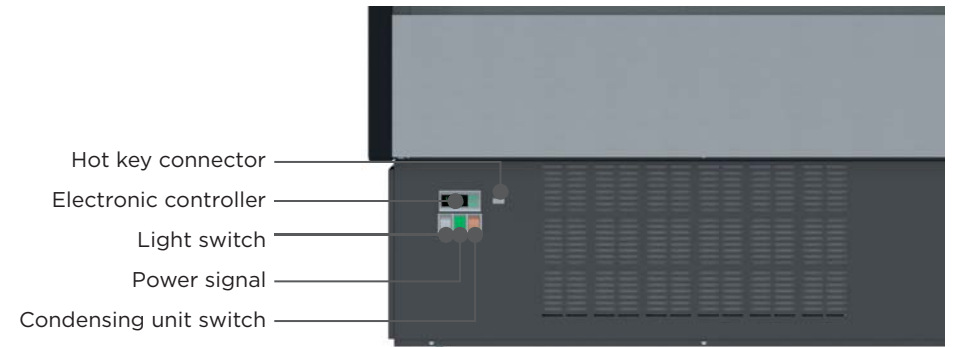

- Hot key connector
- Electronic controller
- Light switch
- Power signal
- Condensing unit switch

Remote control panel (KGH-OF/FD/OS/DS/MS)

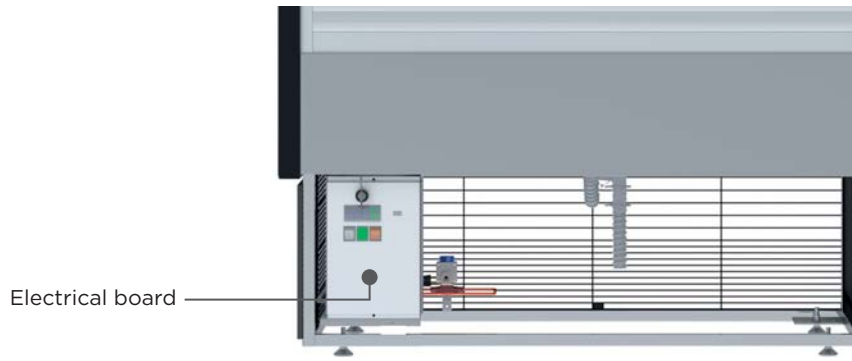
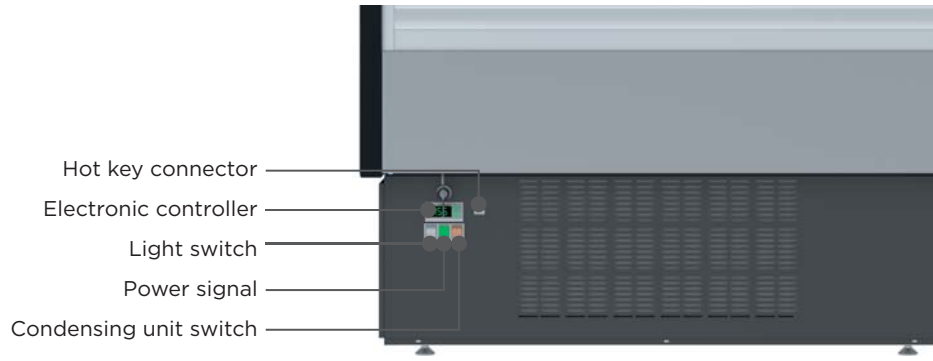

Remote control panel (KGH-ES)

Self contained and Remote labels

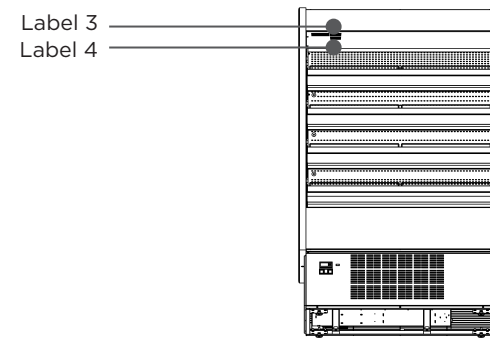

Self contained and Remote labels (evaporator)

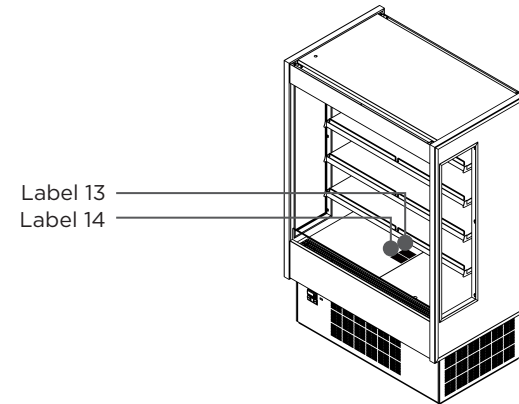



Self contained labels

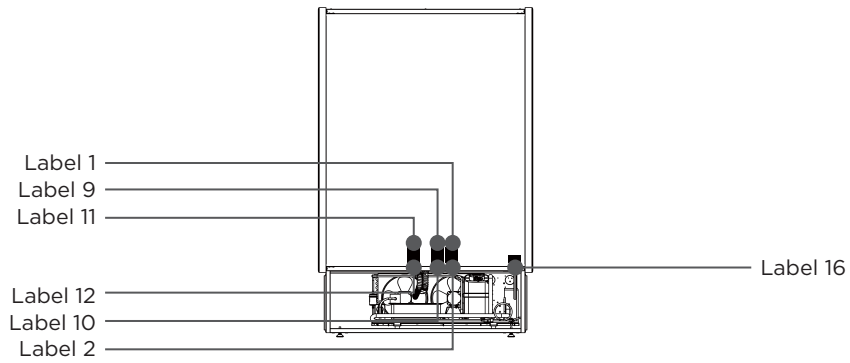

Remote labels

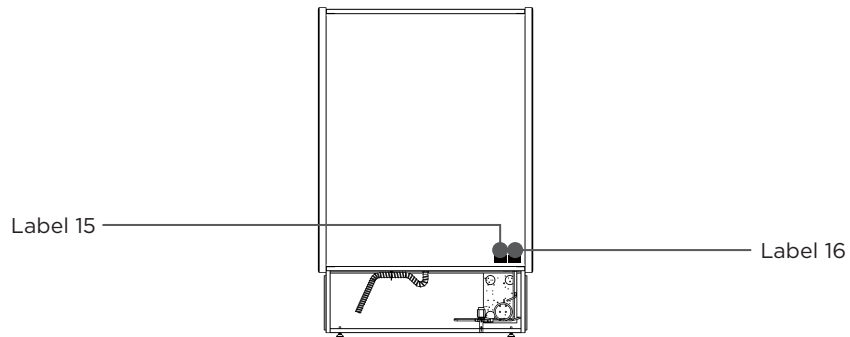

Self contained labels (Shutter rails)

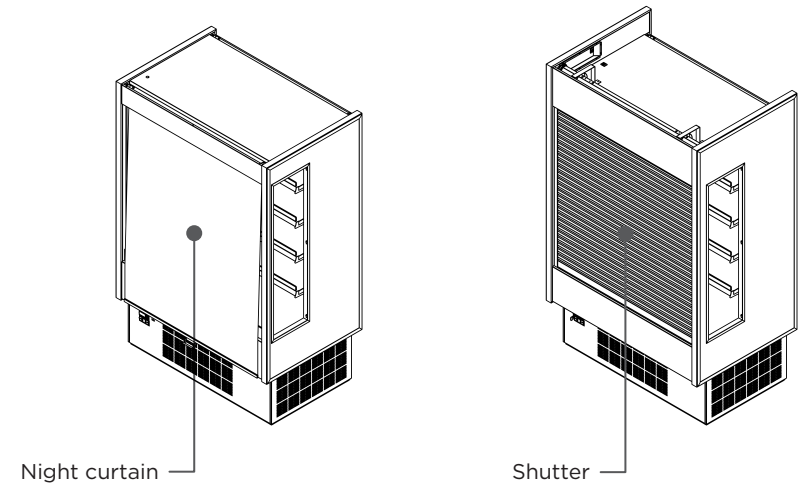
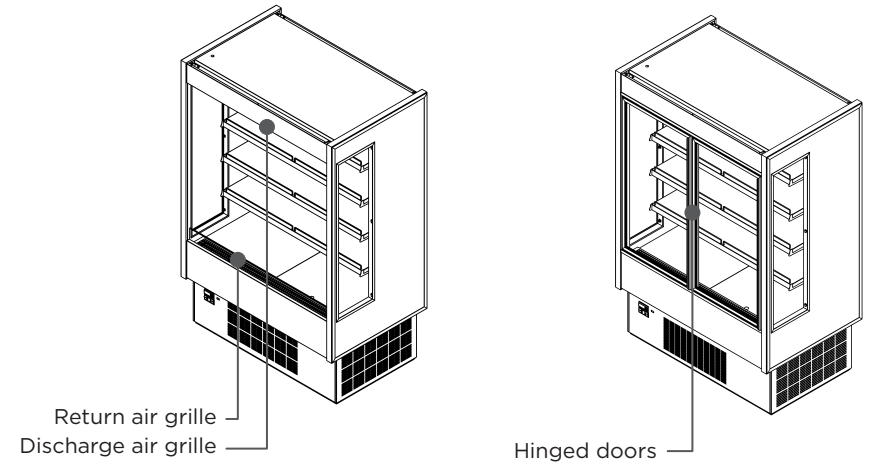
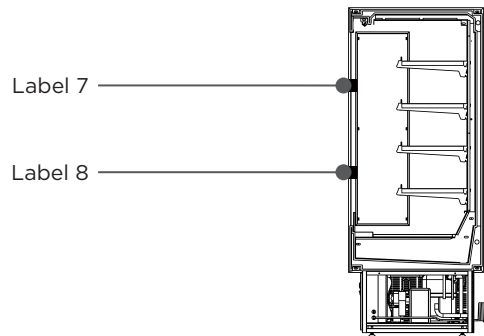

2.5 Check serial, model numbers and requested options

Before start your equipment, check the serial number, model numbers and requested options.  
This inspection should be made visually in the following items:



Self contained numbers

<b>MVP GROUP CORP.</b>		COMMERCIAL REFRIGERATOR CONFORMS TO UL STANDARD 471 AND NSF STD 7 CERTIFIED TO CAN/CSA STD C22.2 NO. 120	
For service, please call: (514) 737-9701			
www.mvpgroupcorp.com		Intertek 4004083	
<b>MADE IN PORTUGAL</b>		120V CIRCUIT	
<b>ETL MODEL</b>	EVAP PAN	DOOR HEATER	ANTI-S FANS
<b>CASE FAMILY</b>	REF AMOUNT LEFT	REF AMOUNT RIGHT	EVAP FANS
<b>SERIAL NO.</b>	REF LEFT	REF RIGHT	COND FANS
<b>DATE MFG</b>	PSI HIGH SIDE	PSI LOW SIDE	COMP
	psia	psia	--AMPS--
			--QTY--
			--PHASE--
			--HRTZ--
			LRA--
			MINI BRANCH
			CIRCUIT AMPACITY
			MAX OVERCURRENT
			PROTECTION AMPS
			TOTAL CASE AMPS



Remote numbers

<b>MVP GROUP CORP.</b>		COMMERCIAL REFRIGERATOR CONFORMS TO UL STANDARD 471 AND NSF STD 7 CERTIFIED TO CAN/CSA STD C22.2 NO. 120	
For service, please call: (514) 737-9701			
www.mvpgroupcorp.com		Intertek 4004083	
<b>MADE IN PORTUGAL</b>		120V CIRCUIT	
<b>ETL MODEL</b>	REF TYPE	DOOR HEATER	ANTI-S FANS
<b>CASE FAMILY</b>	PSI HIGH SIDE	LIGHTS	EVAP FANS
<b>SERIAL NO.</b>	psia		--AMPS--
<b>DATE MFG</b>			--QTY--
			--PHASE--
			--HRTZ--
			MINI BRANCH
			CIRCUIT AMPACITY
			MAX OVERCURRENT
			PROTECTION AMPS
			TOTAL CASE AMPS

## 2.6 Warning/Caution labels

Before starting, HYDRA KOOL products have caution and warning labels to be respected.

### Self contained labels

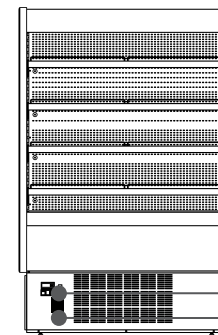

Label 5  
Label 6

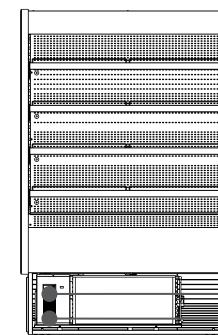

Label 9  
Label 10

### Remote labels

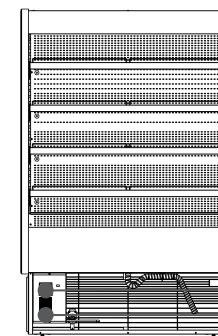

Label 9  
Label 10