



---

Adam Equipment

# DUNE SERIES

Software Revision V1.25 & above

# ENGLISH

**Easy Reference:**

Model name of the scale:	
Serial number of the unit:	
Software revision number (Displayed when power is first turned on):	
Date of Purchase:	
Name of the supplier and place:	

## 1.0 CONTENTS

PN 9384 RevB4-September 2016

1.0	CONTENTS .....	3
2.0	INTRODUCTION .....	3
3.0	SET UP .....	4
3.1	UNPACKING AND SETTING UP YOUR SCALE .....	4
3.2	LOCATING AND PROTECTING YOUR SCALE .....	6
4.0	BASIC OPERATION .....	7
4.1	TURNING ON THE SCALE.....	7
4.2	ZEROING / TARE.....	7
4.3	WEIGHING .....	7
5.0	FUNCTIONS.....	8
5.1	AUTO POWER OFF .....	8
6.0	CALIBRATION .....	8
7.0	TROUBLE SHOOTING .....	9
7.1	ERROR MESSAGES .....	9
8.0	SPECIFICATIONS.....	10
9.0	WARRANTY INFORMATION .....	10

## 2.0 INTRODUCTION

Thank you for purchasing the **Dune™**, **DCT** compact scales. Every **Dune** is equipped with the features you really need: DC adapter, auto-calibration through the keypad, low-battery indicator, and overload indicator. With its alternate battery operation, splash-proof key pad, and sturdy plastic construction throughout, the Dune will deliver accurate readings both indoors and out.

## 3.0 SET UP

### 3.1 UNPACKING AND SETTING UP YOUR SCALE

- 1) Remove the top pan, scale and adaptor from the packaging. Take care not to apply pressure to the top of the scale.
- 2) Connect the power adapter to the socket on the back of the machine.

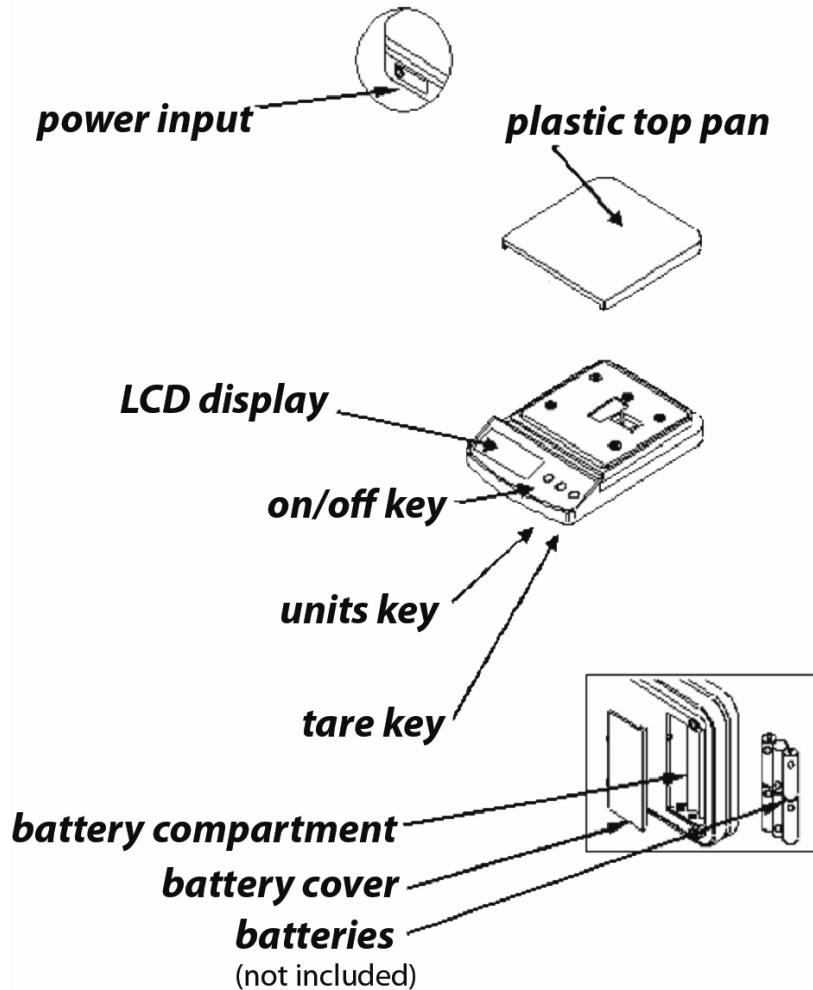

#### **Installing Batteries:**





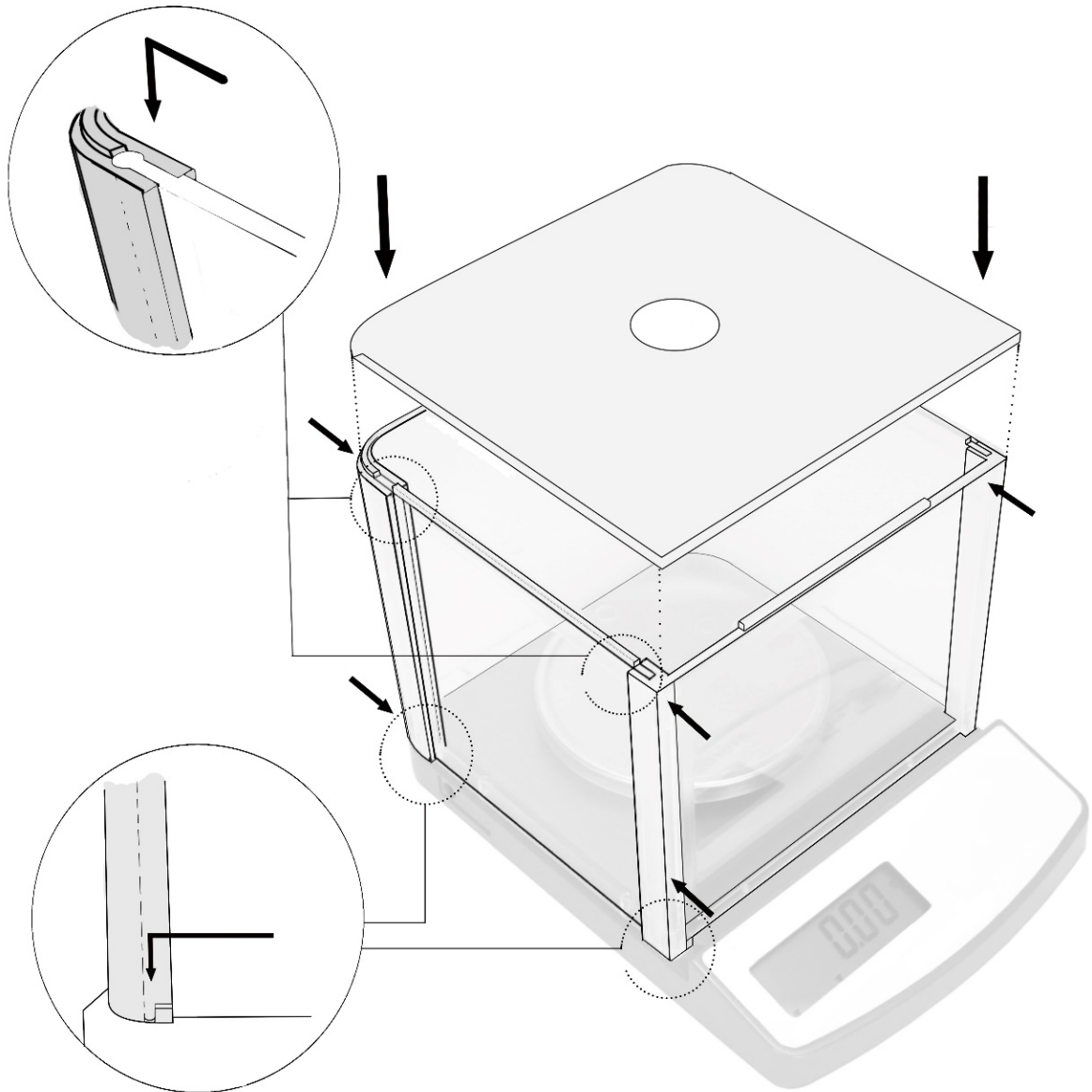

Remove the battery compartment cover and insert six batteries (R6P/LR6 /AA size) into the battery compartment taking extreme care that the polarities plus and minus are observed.

**DCT 302: Breeze Shield**

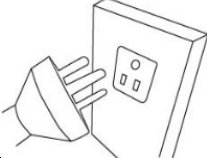
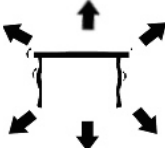

### 3.2 LOCATING AND PROTECTING YOUR SCALE

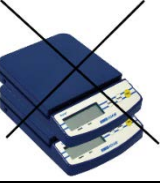
In order to keep your scale functioning at its best we suggest that you do the following:

	<p>Avoid extremes of temperature. Do not place in direct sunlight or near air conditioning vents.</p>
	<p>Make sure the scale is located on a strong table and free from vibration.</p>
	<p>Avoid unstable power sources. Do not use near large users of electricity such as welding equipment or large motors. Do not mix batteries and use only the factory approved power adapter supplied with the machine. Do not use batteries and the DC adapter at the same time.</p>
	<p>Keep free from vibration. Do not place near heavy or vibrating machinery.</p>
	<p>Avoid high humidity that might cause condensation. Keep away from direct contact with water. Do not spray or immerse the scales in water.</p>
	<p>Do not place near open windows, air-conditioning vents or fans that may cause a draft and unstable readings.</p>
	<p>Keep the scales clean. Do not stack material on the scale / balance when it is not in use.</p>
	<p>Avoid operating in high static areas, or weighing high static materials, such as plastics or powders, as this may damage electronics and affect measurements. Use grounding mats or bonding straps to reduce potential</p>

## **4.0 BASIC OPERATION**

### **4.1 TURNING ON THE SCALE**

Plug in the unit using the DC adapter or use batteries. Do not use battery power and the DC adapter at the same time.

- 1) To turn on press the **[on/off]** key once and release. All of the segments on the display will light up, then the display shows zero >0<
- 2) The scale is ready to be used.
- 3) To turn the scale off after use press the **[on/off]** key again. There is an auto power-off function that will automatically turn the unit off after 4 min of inactivity or no change in the weight reading.

### **4.2 ZEROING / TARE**

You can press the **[Tare]** key to set a new zero point and show the zero reading if the weight reading is less than 4% of the total of the maximum capacity of the scale. This may be necessary if the weight is not reading zero with nothing on the platform. The zero indicators will light up: >0<.

If you are using a container to weigh then you can place this on the platform and press the **[Tare]** key, providing the container weight is more than 4% of the maximum capacity of the scale, the display will show zero and tare indicator will light up. You can then weigh your object in the container. Taring weight subtracts from the total scale capacity.

**Note:** When the container is removed a negative value will be shown. If the scale was tared just before removing the container, this value is the gross weight of the container plus all products which were removed.

### **4.3 WEIGHING**

To determine the weight of a sample, first tare an empty container (if used), then place the sample in the container. The display will show the weight and the unit of weight currently in use.

## 5.0 FUNCTIONS

### 5.1 AUTO POWER OFF

The auto power off helps conserve power when using on battery or the DC adapter, the machine will automatically turn off after 4 min of inactive use or no change in the displayed weight.

## 6.0 CALIBRATION

Before calibrating the Dune series it is best to turn on the unit for about 1 min to let the components warm up.

- 1) Press **[on/off]** key to turn the power on, if it is not already.
- 2) Press and hold the **[Unit]** key, until "CAL" is displayed
- 3) Remove any weight from the pan.
- 4) Press the **[Unit]** key, the display will flash "CAL" then will show the cal mass required. If the cal mass is not displayed then the machine is not stable or is not within a zero range. Turn off the unit and try zeroing the display before trying another calibration.
- 5) Place the appropriate calibration mass on the scale:

Model	Calibration Mass
DCT 201	200g
DCT 302	200g
DCT 601	500g
DCT 2000	2000g
DCT 2001	2000g
DCT 5000	5000g

- 6) After the stable reading the display will show "PASS" then revert to the weighing mode. If the calibration does not pass the display will show "FAIL" and shut off.
- 7) The calibration is now finished. If the calibration is correct, the display will show the weight value.



**NOTE:** If the calibration fails, retry. If it continues to fail then there may be damage to the mechanics or an issue with the power. If you do not follow the procedures in a timely manner the machine will automatically switch off and the calibration will not be accepted.

## 7.0 TROUBLE SHOOTING

### 7.1 ERROR MESSAGES

If an error message is shown, repeat the step that caused the message. If the error message is still shown then contact your dealer for support.

ERROR CODE	DESCRIPTION	POSSIBLE CAUSES
O-Ld	Overload	Remove weight from the pan. Make sure the machine is reading zero before weighing. Do not over load the pan. If the problem recurs calibrate. Possible damage to the internal weighing cell.
OUt2	Out of Zero reading	Make sure the pan is fitted correctly. Make sure nothing is touching the pan when turning on the unit. Calibrate the machine. Possible damage to the internal weighing cell.
UnSt	Unstable	Make sure the balance is on a flat surface and away from vibration. Possible damage to the internal weighing cell.
LO or 	Low Battery indicator	Change the batteries or use on the power adapter.
ErrE	E-Prom error	Software error turn off and restart. Contact Adam Equipment or your dealer for further assistance.
	No Power when turning on	Change the batteries or use on the power adapter.

## 8.0 SPECIFICATIONS

Model Number	DCT 302*	DCT 201	DCT 601	DCT 2000	DCT 2001	DCT 5000
Maximum Capacity	300g	200g	600g	2000g	2000g	5000g
Readability	0.01g	0.1g	0.1g	1g	0.1g	2g
Repeatability (Std Dev)	0.02g	0.2g	0.2g	2g	0.2g	4g
Linearity $\pm$	0.03g	0.3g	0.3g	3g	0.3g	6g
Units of Measure	g / lb / oz					
Stabilisation Time	2 seconds					
Operating Temperature	0°C to 40°C			32°F to 104°F		
Power Supply	12VDC 500 mA adapter (800mA South Africa), or 6x AA batteries					
Calibration	Push button calibration using external mass					
Calibration Mass	200g	200g	500g	2000g	2000g	5000g
Display	5 digit LCD display 15mm high					
Balance Housing	ABS Plastic					
Pan Size	100mm $\phi$ x7mm	145 x 145mm 5.8" x 5.8"				
Overall Dimensions (w x d x h)	145 x 210 x 40mm 5.8" x 8.3" x 1.6"					
Gross Weight	1kg, 2.2lb					
Features	Low battery, Stable and Zero indications					
*Draught Shield (w x d x h)	145 x 148 x 120mm		5.71" x 5.82" 4.72"			

## 9.0 WARRANTY INFORMATION

Adam Equipment offers Limited Warranty (Parts and Labour) for any components that fail due to defects in materials or workmanship. Warranty starts from the date of delivery.

During the warrant period, should any repairs be necessary, the purchaser must inform its supplier or Adam Equipment Company. The company or its authorized Technician reserves the right to repair or replace the components at any of its workshops at no additional cost, depending on the severity of the problems. However, any freight involved in sending the faulty units or parts to the Service Centre should be borne by the purchaser.

The warranty will cease to operate if the equipment is not returned in the original packaging and with correct documentation for a claim to be processed. All claims are at the sole discretion of Adam Equipment.

This warranty does not cover equipment where defects or poor performance is due to misuse, accidental damage, exposure to radioactive or corrosive materials, negligence, faulty installation, unauthorized modifications or attempted repair, or failure to observe the requirements and recommendations as given in this user manual.

This product may include a rechargeable battery that is designed to be removed and replaced by the user. Adam Equipment warrants that it will provide a replacement battery if the battery manifests a defect in materials or workmanship during the initial period of use of the product in which the battery is installed.

As with all batteries, the maximum capacity of any battery included in the product will decrease with time or use, and battery cycle life will vary depending on product models, configuration, features, use, and power management settings. A decrease in maximum battery capacity or battery cycle life is not a defect in material or workmanship, and is not covered by this Limited Warranty.

Repairs carried out under the warranty do not extend the warranty period. Components removed during the warranty repairs become company property.

The statutory rights of the purchaser are not affected by this warranty. The terms of this warranty is governed by the UK law. For complete details on Warranty Information, see the terms and conditions of sale available on our website.

## WEEE 2012/19/EU



(SLA Battery containing Pb is optional extra and not fitted as standard to all models).

This device may not be disposed of in domestic waste. This also applies to countries outside the EU, per their specific requirements. Disposal of batteries (if fitted) must conform to local laws and restrictions.

Cet appareil ne peut être éliminé avec les déchets ménagers. L'élimination de la batterie doit être effectuée conformément aux lois et restrictions locales.

Dieses Gerät nicht mit dem Hausmüll entsorgt.

Dispositivo no puede ser desechado junto con los residuos domésticos

Dispositivo non può essere smaltito nei rifiuti domestici.

### FCC / IC CLASS A DIGITAL DEVICE EMC VERIFICATION STATEMENT

NOTE: This equipment has been tested and found to comply with the limits for a Class A digital device, pursuant to Part 15 of the FCC rules and Canadian ICES-003/NMB-003 regulation. These limits are designed to provide reasonable protection against harmful interference when the equipment is operated in a commercial environment. This equipment generates, uses and can radiate radio frequency energy and, if not installed and used in accordance with the instruction manual, may cause harmful interference to radio communications. Operation of this equipment in a residential area is likely to cause harmful interference in which case the user will be required to correct the interference at his own expense.

### CALIFORNIA PROPOSITION 65 - MANDATORY STATEMENT

(SLA Battery containing Pb is optional extra and not fitted as standard.)

WARNING: This product includes a sealed lead-acid battery which contains chemicals known to the State of California to cause cancer and birth defects or other reproductive harm.



Adam Equipment products have been tested with, and are always supplied with mains power adaptors which meet all legal requirements for the intended country or region of operation, including electrical safety, interference and energy efficiency. As we often update adaptor products to meet changing legislation it is not possible to refer to the exact model in this manual. Please contact us if you need specifications or safety information for your particular item. Do not attempt to connect or use an adaptor not supplied by us.

## BE ADAM<sup>®</sup>

### Certificate of Calibration

This is to certify that the **Dune™** series of balances manufactured and distributed by Adam Equipment at the time of manufacturing passed calibration tests to the tolerances as outlined in the specifications section of this manual. Outside influences that may affect the calibration since that time may cause a change in the calibration data. We therefore recommend that a calibration is performed onsite and that regular calibration is undertaken.

Calibration Weights: The weights used to calibrate by the factory met ASTM / OIML standards and were accurate to OIML Class M1 / ASTM Class 4

Calibration Standards: Factory calibration was performed as described in the calibration section of this manual

**ADAM EQUIPMENT** is an ISO 9001:2008 certified global company with more than 40 years' experience in the production and sale of electronic weighing equipment.

Adam products are predominantly designed for the Laboratory, Educational, Health and Fitness, Retail and Industrial Segments. The product range can be described as follows:

- Analytical and Precision Laboratory Balances
- Compact and Portable Balances
- High Capacity Balances
- Moisture analysers / balances
- Mechanical Scales
- Counting Scales
- Digital Weighing/Check-weighing Scales
- High performance Platform Scales
- Crane scales
- Mechanical and Digital Electronic Health and Fitness Scales
- Retail Scales for Price computing

© Copyright by Adam Equipment Co. All rights reserved. No part of this publication may be reprinted or translated in any form or by any means without the prior permission of Adam Equipment.

Adam Equipment reserves the right to make changes to the technology, features, specifications and design of the equipment without notice.

All information contained within this publication is to the best of our knowledge timely, complete and accurate when issued. However, we are not responsible for misinterpretations which may result from the reading of this material.