



KWIKOOL SERIES KPOX-XX PORTABLE AIR CONDITIONER



OPERATION MANUAL

Table of Contents

SECTION 1	UNIT COMPONENTS	4
	KPO5	4
	KPO12	5
	KPO25	6
SECTION II	INSTALLATION AND ASSEMBLY.....	7
A	PREVIEW THE INSTALLATION SITE.....	7
B	INSTALLATION	7
C	POWER CONNECTION	7
D	INSTALL CONDENSATE LINE	8
E	INSTALL CONDITIONED AIR SUPPLY AND RETURN FLEX DUCT.	8
SECTION III	OPERATIONAL SAFEGUARDS	10
SECTION IV	UNIT OPERATION	11
A	STARTUP	11
B	LCD BUTTONS FUNCTIONALITY TABLE	12
C	OPERATING MODES	13
SECTION V	BUILT IN SAFEGUARDS	15
A	COMPRESSOR TIME DELAY	15
B	HIGH-PRESSURE SWITCH AND ALARM	15
C	LOW PRESSURE SWITCH AND ALARM	15
D	SERVICE PORTS.....	15
E	SIGHT GLASS.....	15
F	AUTOMATIC RESTART	16
G	CONDENSATE PUMP & HIGH-LEVEL ALARM	16
H	POWER/PHASE MONITOR.....	16
I	VFD-VARIABLE FREQUENCY DRIVE.....	16
SECTION VI	APPLICATION REQUIREMENTS.....	16
A	AIR TEMPERATURE REQUIREMENTS COOL MODE	16
B	CAPACITY & TEMPERATURE SETTINGS.....	17
C	POSITIONING OF UNIT.....	17
SECTION VII	MAINTENANCE	18
A	AIR FILTERS.....	18
B	CONDENSER DRIVE BELTS	18
SECTION VIII	- UTILIZING THE KWIKOOL KPO SYSTEM.....	19
SECTION IX	– TECHNICIAN/STAFF SETTINGS	19
	TECHNICIAN PARAMETER LIST	19
SECTION X	- USER PARAMETER SETTINGS.....	19
	USER PARAMETER LIST	20

SECTION XI - ALARM CODES LIST20
 ALARM CODES LIST 20

SECTION XII - KPO TROUBLESHOOTING GUIDE21
 KPO TROUBLESHOOTING TABLE 21

SECTION 1 UNIT COMPONENTS

Before installing and using the KwiKool KPO Series Portable Air Conditioner, read this manual carefully for instructions on proper usage and all safeguards. This manual should be retained for future reference.

There are three sizes of KPO systems. These are KPO5, KPO12 and KPO25. Before installing and using the KPO systems, read this manual carefully for instructions on proper usage and all safeguards. This manual should be kept for future reference.

KPO5

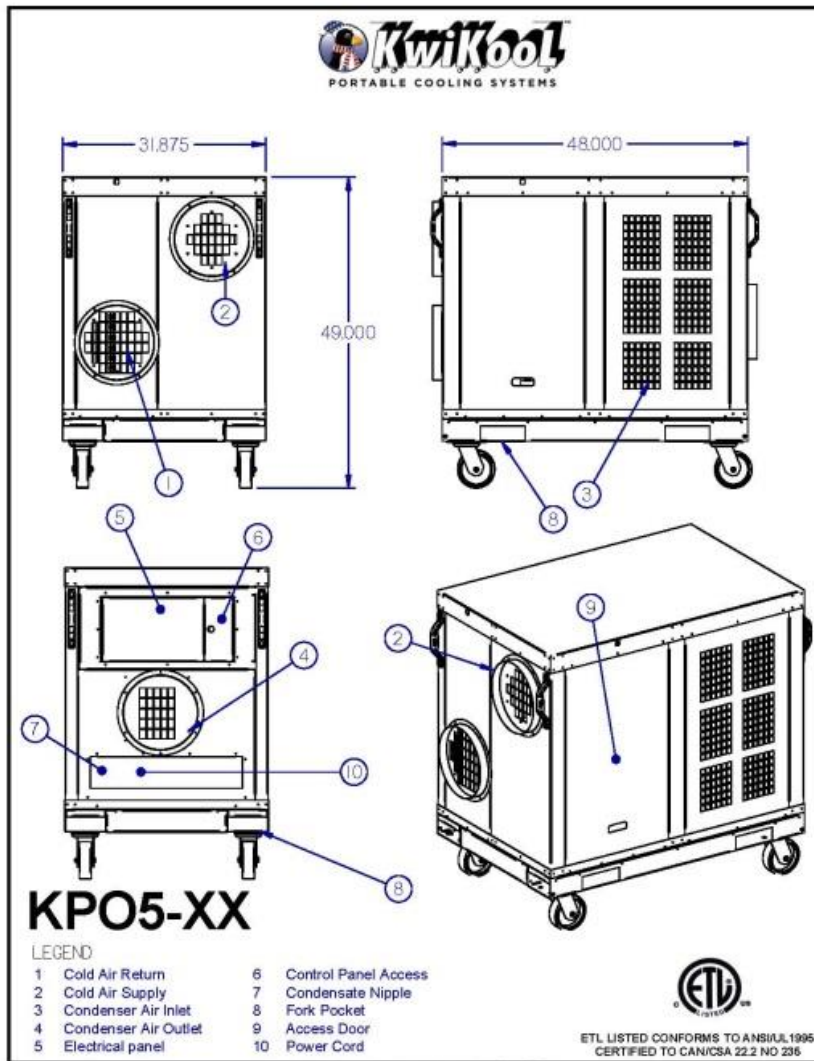

1-800-KWIKOOL

www.kwikool.com

KPO12

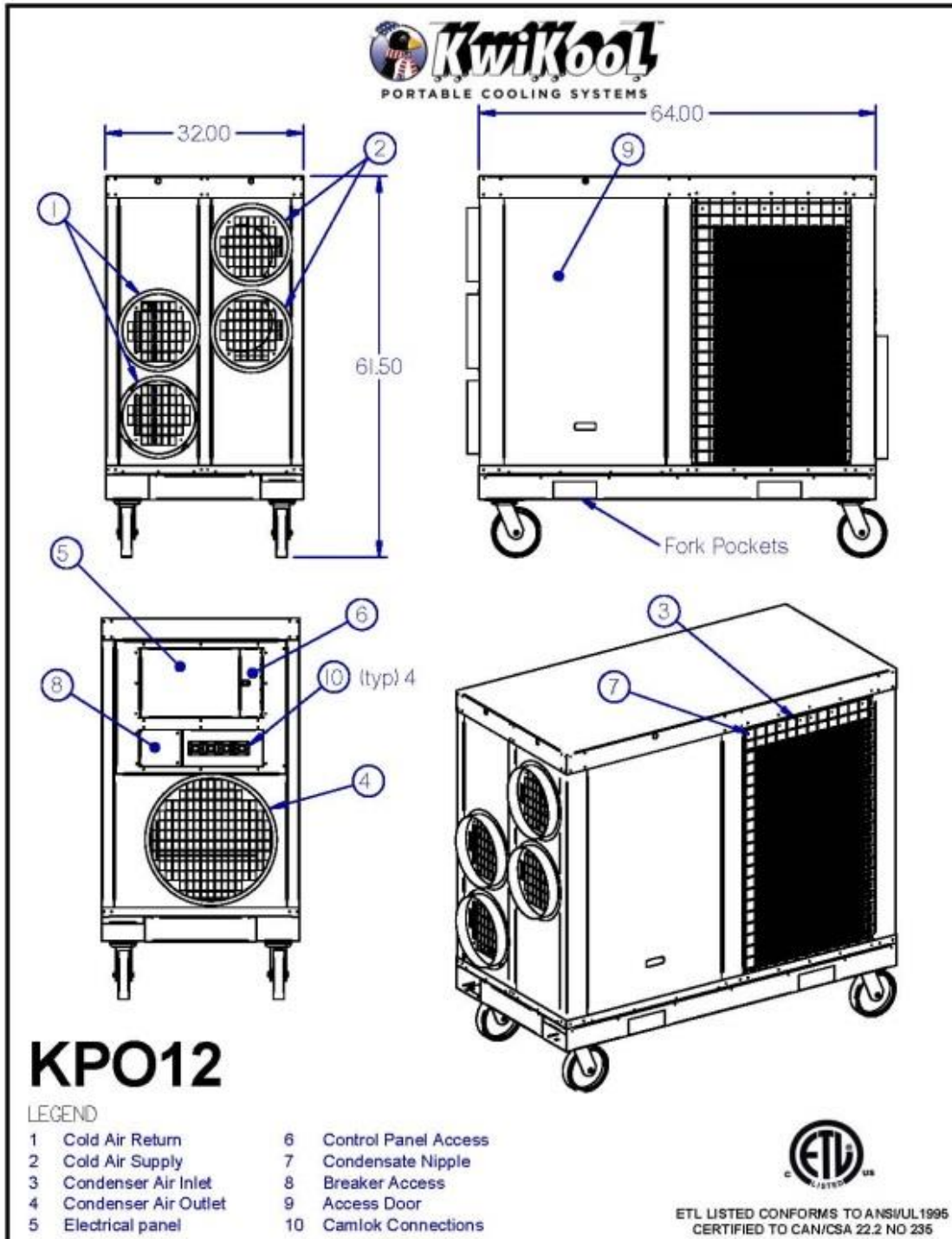

1-800-KWIKOOL
www.kwikool.com

KPO25

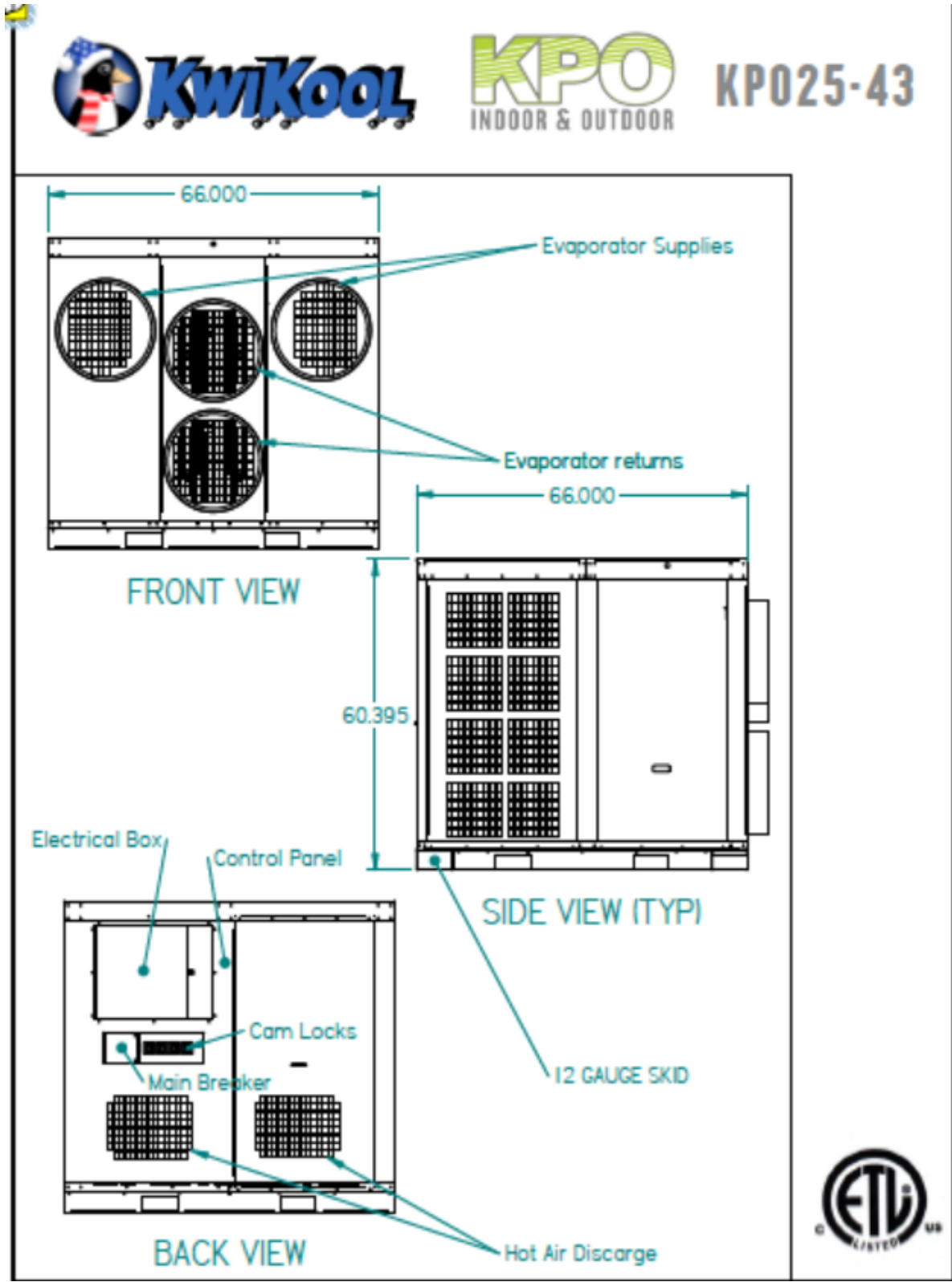

SECTION II INSTALLATION AND ASSEMBLY

A PREVIEW THE INSTALLATION SITE

WARNING

In COOL Mode, DO NOT place the KPOXX in the space that is being cooled. The KPO is designed to be outside the conditioned space and ducted in.

Before moving the KPO/KPOXX into place, verify the following:

- The direction from which the supply air is coming
- The direction to which the return air is going (cooling)
- The direction to which the hot air exhaust is going (heat removal)
- The direction from which the condenser make-up air is coming
- The location of the power supply
- The direction to which the condensate water will be pumped

Position the unit based on these guidelines for best results.

NOTE

Leave at least five feet of open space around the make-up air inlets for the condenser to ensure proper operation.

B INSTALLATION

1. Install casters-(KPO5 & KPO12 only).
2. Lift the unit carefully with a forklift using the built-in fork pockets. Do not tilt the unit to bolt the casters to the base
3. Install and tighten the bolts and nuts, four for each caster.
4. Install flanges.
 - a) Install flanges with fasteners that are included with the collars
 - b) Start two fasteners in the top two female inserts that are around each inlet or outlet on the KPO
 - c) Hang the collar on the two fasteners that are started in the insert
 - d) Push the collar flush with the cabinet
 - e) Install the remaining fasteners and tighten well. Loose flanges will leak air and diminish performance

C POWER CONNECTION

Verify the source power, phase and breaker size is compatible with the unit's serial plate information. If in doubt, contact a licensed electrician.

The KPO5-ton comes from the factory with eight feet of power cable sized to fit the electrical specification of the units' electrical requirement and has no male receptacle attached. Optional male cam locks can be ordered from the factory.

The KPO12-ton & 25-ton comes without power cable and has four male cam lock connectors ready to receive the corresponding female cam locks.

Female cam locks, or complete power cord line sets, can be bought separately with the proper cable size attached from the factory in various lengths.

D INSTALL CONDENSATE LINE

The KPO series come equipped with a high lift condensate pump.

- It is important to connect the condensate line prior to connecting the electrical power, as the condensate pump is live when the power is engaged. Collected water in the pump's reservoir could be ejected when powered up.
- KPO-5 and 12-ton models, the connection is a ¼-inch outer diameter barbed fitting located on the left side as the operator faces the control just below the handle.
- On 25-ton models, the connection is a ¼-inch outer-diameter barbed fitting located on the left side of the unit while facing the control recessed in the center column.

E INSTALL CONDITIONED AIR SUPPLY AND RETURN FLEX DUCT.

1. The supply air works best directed to equipment inlets or directly on the area to be conditioned.
2. The KPO series requires ducts to direct the cooling or heating into the conditioned space. This is done with 12" duct on KPO5 & KPO12 and 20" duct on KPO25.
3. As the operator faces the unit opposite to the control end, the air supply is on the right side on KPO5 and KPO12 models. On KPO25 systems, the air supplies are located on a 20" flange on each side of the system.
4. Clamp supply ducting onto the flange(s) and route the duct to the desired location.
5. Install Conditioned Air Return Flex Duct.
6. The KPO portable works best when the return air duct is close to the area of highest load. This placement allows the unit to return the load directly to the evaporator and not to linger in the conditioned space.
7. This is also done with 12" duct on KPO5 and KPO12 and 20" duct on KPO25.
8. As the operator faces the unit opposite the control end, the return is on the left side on KPO5 and KPO12. The return is two 20" flanges in the center panel on KPO25.
9. Clamp return ducting onto the flange(s) and route the duct to the desired location.

CAUTION

The return air duct is pulling in air and can collapse while operating. Avoid this condition by pulling all the slack out of the duct and anchoring it to a fixed object. Duct collapse is the number one cause of evaporator coil freeze or low performance.

NOTE

KPO models utilize high static blowers. The KPO systems must have a minimum of 25 feet of ducting for each inlet and outlet. KPO12 and KPO25 must have 100 total feet of duct (min 2 ducts). KPO5 must have 50 feet of total ducting (min one duct). For example, if using a KPO12, 100 feet of duct is needed. Use four 25-foot pcs or two 50-foot pcs on any outlet. If unsure about the current application, call KWIKOOL at 1-800-KWIKOOL.

Customers using this unit only to blow conditioned air and that are not trying to condition a space may not need to connect a return air duct. However, the KPO series requires a minimum amount of duct to operate (see specifications). If operating this unit with no ducting, reduce the return air by at least 50%.

CAUTION

Allowing the KPO to operate without duct or without reducing the return air could cause condensate water leakage, diminished temperature difference and/ or evaporator motor failure.

Install condenser flex duct, hot air discharge in COOL mode.

- Direct the hot air discharge away from the conditioned space and away from the condenser air intakes. This is especially true when the KPO is used in a confined space or indoor closed space. This is done with 12" duct on KPO5 and a 20" duct on KPO12 and KPO25.
- For the 12- and 25-ton KPO (the 25-ton KPO has 2 20" ducts) and one 12" duct for the 5-ton KPO, clamp the duct onto the flange(s) on the control side of the KPO and route to the desired location. See specifications for maximum duct length.

NOTE

It is not necessary to connect hot air discharge duct if using the KPO in heat mode or outdoors and ducting cooling into a space.

When used indoors or in a confined space in COOL mode, and the hot air exhaust is ducted out, the KPO must have a supply of makeup air for the condenser. The condenser make-up air cannot be ducted into the KPO on standard models and must come from the surrounding space.

CAUTION

Make sure there is adequate fresh air supply, or the unit will shut down on High Pressure alarm (HP) to protect the compressor from catastrophic failure.

SECTION III OPERATIONAL SAFEGUARDS

Read the following warnings and safeguards carefully before installing or moving the KwiKool.

WARNING

Do not operate or install the KwiKool unit in a potentially explosive, combustible, or corrosive gas atmosphere.

WARNING

To avoid electrical shock, keep the KwiKool system away from direct contact with water and any liquids. Do not touch the system with wet hands.

WARNING

To avoid burns and fire damage, keep the KwiKool system away from flammable materials and open flame.

WARNING

Do not move the system while it is operating. Before moving the system, first turn to OFF then unplug the system from the power source. Remove all pipes and hoses attached to the KwiKool unit. Only then should the casters be unlocked.

CAUTION

To ensure the KwiKool system is stable, the floor on which the system is to be placed should be level, free of vibration and strong enough to support the weight of the KwiKool model. Lock casters to prevent unit movement.

CAUTION

Do not tilt or overturn the unit, since this could damage the compressor.

- Do not place objects on top of the unit.
- Do not insert the hand or any other object into the cold air supply chutes.
- Do not operate the KwiKool system with its service doors open.

If the KwiKool system makes abnormal noises or vibrations, call KwiKool at 1-800-594-5665.

SECTION IV UNIT OPERATION

A STARTUP

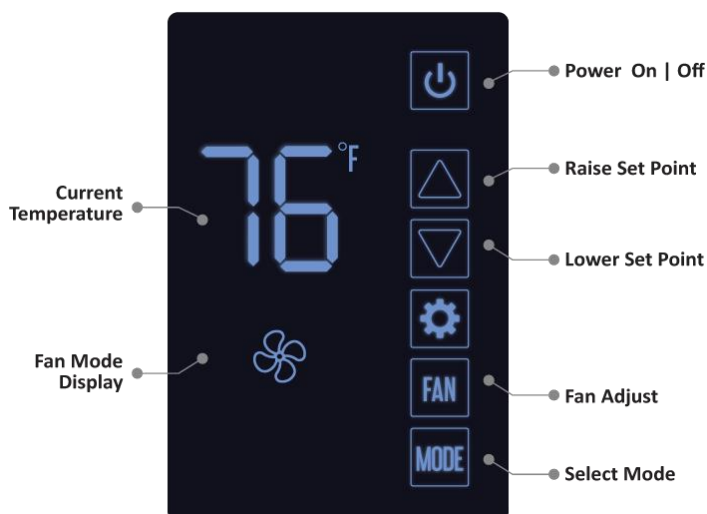

1. Apply electrical power. When power is supplied to the unit, the controller will become operational. All KPO systems are equipped with a power/ phase monitor.
2. KPO12 and KPO25 users will have to place the unit's built in breaker to the ON position to engage the controller.
3. Turn the system to **ON**. If less than 30 seconds have elapsed from the time power is engaged, an audible alarm will sound. The control will display **AL** and **PH**. This is a normal condition. If the PH appears, this is a fault. Incorrect phase is the most common cause in 3-phase systems.
 - a) If the Alarm and **PH** display fails to clear in 30 seconds on a 3-phase system, qualified personal may turn the source power off and swap any of the 3-line voltage wires with each other.

CAUTION











The green wire is the ground wire and is not to be inserted/ swapped into the phase wiring cam lock or damage may result.

- b) Power the unit back up, wait for 30 seconds and then proceed to the next step. If the fault fails to clear after changing the phase, turn the power off at the source, return the wires back to the original configuration and refer to the troubleshooting section of this manual.
4. Set the controller - The controller of the KPO is factory set to **OFF**. In the **COOL** mode, with manual fan engaged and set to start cooling if temperature is above 72 degrees Fahrenheit, displays the current room temperature and is set to come on within a 2-degree temperature difference.

NOTE

*The control memory holds the last parameters entered, including **ON** and **OFF**, if power is turned off or lost and then restored.*

B LCD BUTTONS FUNCTIONALITY TABLE

BUTTON	OPERATION INSTRUCTIONS	FUNCTION
On/Off 	Short Press	Start or Stop Operation
On/Off 	Short Press	EXIT, in Tech and User Settings List
Up or Down Arrows 	Short Press	Change Set Point Temperature
Up or Down Arrows 	Short Press	Change Parameter Value, in Tech and User Settings List
Up or Down Arrows 	Constant Press	Rapid Value Change of Parameter or Set Point
Mode 	Short Press	Scrolls Thru Available Operations
Mode 	Short Press	Goes to Next Parameter, in Tech and User Settings List
Settings 	Short Press	Change to F or C for Temperature Display
Settings 	Long Press (5 seconds)	Enter User Settings
FAN 	Short Press	Auto Fan ON or OFF
FAN 	Short Press	Go to Previous Parameter, in Tech and User Settings List

1. Press the **ON/OFF** icon. A short press on this button turns the system on or off and the system operates in the last parameter that was entered in operating Mode.
2. A short press on the **UP** or **DOWN** arrows raises or lowers the set point in the current operational mode.
3. A short press on the **MODE** icon changes the operating mode to **COOL, HEAT, FAN, AUTO SWITCH HEAT/COOL** (Optional) which is signified by both **HEAT** and **COOL** icons being displayed simultaneously.

NOTE

*In each mode except **FAN**, the currently operating mode is blinking on and off while operating in that mode. If the icon is not flashing, then the system is not calling for that operation because the set point is met, or the system may be in time out, signified by the **F** or **C** next to the room temperature display blinking on and off.*

4. A short press on the FAN icon changes the system to **AUTO FAN** or **MANUAL FAN** in the **COOL** mode.

- When set in **AUTO FAN (AF)**, the supply air in **COOL** mode will only operate when the compressor is on. The letters **AF** show on the display when using this feature
- When set in **MANUAL FAN**, the supply air fan in the **COOL** mode is always on. **AF** will not display in **MANUAL FAN**. This feature is only available in **COOL** mode
- The supply air is always on in **HEAT** or **FAN** mode and the supply air may operate in the **OFF** mode if set in **HEAT** and turned off before the cycle was completed

C OPERATING MODES

FAN MODE

1. Set mode to fan.
2. The fan icon displays solid and the supply air fan starts with no cooling or heating operation.
3. A short press on the power button stops the fan operation.

COOL MODE ❄️

1. Set the mode to cool, a 2.5-minute time delay starts for the compressor to prevent short cycling, signified by **F** or **C** blinking on and off on the display
2. Adjust the set point below the room temperature displayed on the control to the desired temperature
3. Select **FAN**. This requires a short press on the icon to display **AF** (AUTO FAN) for supply fan operation when the compressor starts.
4. If already in **ON** mode, a short press on the **FAN** icon begins continuous supply fan operation (**AF** will not display when using this feature).
5. Press **ON**. If the time delay is finished, the icon for **COOL** starts to blink, the compressor starts, and cooling will begin. After the system has built up enough pressure, the hot air exhaust fan will start to ramp up. It is normal for this fan to delay in starting and normal for it to slow down and speed up during the operating process.

NOTE

The hot air exhaust fan (condenser discharge) is not operational in Heat or Fan mode. It only operates in Cool mode.

HEAT MODE (Optional)

Set the mode to **HEAT**. Adjust the set point above the room temperature displayed on the control to the desired temperature. Press **ON** and heating will begin.

Fire rated or high temperature duct is NOT required to use with the KPO series in heat mode. The heat rating for KPO systems is as follows: KPO25 is 48 KVA, KPO12 is 24 KVA, and KPO5 is 12 KVA.

NOTE

Operators do not have control of the supply fan in this mode. The supply air fan is always on when ON is selected.

NOTE

The heat function on KwiKool KPO systems will not require a time delay or compressor operation; therefore, there is no delay in starting and no need to manage condensate water or condenser air discharge.

OPERATING MODE, AUTO COOL/ HEAT (optional)  .

1. Set the mode to **HEAT COOL**. Both icons are displayed in this mode.
2. Enter the set point using the **UP** or **Down** arrows.
3. The system will automatically shift between cool or heat, based on demand within a 4-degree temperature difference when turned **ON**. See the example below for more information.

EXAMPLE

The set point is 72 F. The system is set in the **HEAT/COOL** Mode. The room reaches the set point in **COOL** mode and the compressor cycles off. If the temperature in the room continues to drop and gets down to 70 F, then the **HEAT** mode will start and heat will come on until the set point of 72 is reached. The heat then cycles off. If the temperature continues to rise and gets to 74 degrees, the system switches to **COOL** mode and cools the space to the set point and then cycles off. The cooling or heating icon flashes on and off to signify which operation is currently on and the system operates the selected Fan feature for each function.

TECHNICAL SETTINGS 

Access into these operations is described later in this manual. Users and technical staff menus all have different features that allow access into settings and certain functions of the control based on information supplied by the engineers.

CYCLING OF  **POWER ON/OFF BUTTON:**

1. After the system has reached its set point in **Cool** or **Heat** mode it will automatically cycle off or the user may choose to turn the system off by selecting OFF.
2. If the unit cycles off or is turned off, the time delay will always activate when the system again calls for cooling
3. When cycling off by making the set point, the supply air fan stays on in **Heat** mode. In **Cool** mode, the fan stays on only if **MANUAL FAN** is selected.
4. Heating or cooling will begin automatically when the temperature rises above or below the set point, depending on the chosen mode.
5. Turning the system off manually will turn the evaporator fan off and not allow the system to restart until the control is set to ON and the return air temperature is near the set point.
6. In FAN mode the supply air fan only shuts down when OFF is selected.
7. In **Heat** mode, the supply air fan can still operate when turned OFF to cool the heat strips. if the system was turned off before the heat cycle was complete, the fan will shut down when the strips are cool.

SECTION V BUILT IN SAFEGUARDS

A COMPRESSOR TIME DELAY

Protects the KwiKool while in COOL mode from potential damage by delaying the compressor from starting before the pressures in the mechanical system equalize. Always activates when the KwiKool cycles off or is turned off, or if power is lost and then restored.

B HIGH-PRESSURE SWITCH AND ALARM

Protects the KwiKool from potential damage to the mechanical system by shutting down and alerting operators of a condition such as stopped or slowed airflow over the condenser coil, make-up air temperature above operating range, or mechanical failure. If these conditions exist, the KwiKool will sound an audible alarm only, and display HP on the control.

To resume operation, the system requires a manual reset after corrective action is taken.

- The reset switch is located on the left side of the unit as the operator faces the control in the service door access on the compressor discharge line for KPO5 and KPO12. Push in to reset. If activated, the operator will hear a click.
- KPO25 systems have two reset switches located in the return air compartment of the system, mounted one on each side of the compartment. If activated, the operator will hear a click.
- Be sure to reset both switches if getting the HP alarm. If this alarm is engaged the system will not operate in **COOL**, **FAN**, or **HEAT** mode.

C LOW PRESSURE SWITCH AND ALARM

Protects the KwiKool from potential damage to the mechanical system by shutting down and alerting operators of the condition. This safety mode activates when pressures below 20 PSI are detected in the mechanical system of the KwiKool. The KwiKool will sound an audible alarm and displays **LP** on the control. There is an automatic reset upon correction of the low-pressure condition. If this alarm is engaged the system will not operate in **COOL**, **FAN** or **HEAT** mode. Call 1-800-KWIKOOL, if this alarm is present on initial startup.

D SERVICE PORTS

Located in the service access door, on the left side when facing the control panel on KPO5 and KPO12. KPO25 service ports are in the return air compartment. This gives service personal a connection point for service gauges to monitor the operating pressures of the KwiKool.

E SIGHT GLASS

Located in the condenser access compartment on the control side of the KPO, the sight glass allows operators and service personal to view the condition of the refrigerant returning to the evaporator coil. Used as a diagnostic tool by qualified personal.

F AUTOMATIC RESTART

In the event of a power loss, the KwiKool resumes operation when the power is restored if in the ON position. All operational functions are saved in the memory of the control.

G CONDENSATE PUMP & HIGH-LEVEL ALARM

KPO systems are factory-equipped with an internal high lift condensate pump. KwiKool condensate pumps can pump the condensation collected in the reservoir of the pump to a drain or other area approved for the discharge water by attaching ¼" I.D. tubing to the ¼" O.D. barbed condensate outlet. KwiKool condensate pumps have a pump safety cut-off that prevents accidental water overflow by shutting the KwiKool down and alerting operators with an audible alarm and displaying **CP** on the control panel. Call 1-800-KWIKOOL if this alarm is present on initial startup.

The most common reason for this alarm to activate during operation is restricted water flow thru the discharge tubing due to crimping or clogging, or there could be too much length in the discharge line connected to the system. There is an automatic reset upon correction of the condensate flow. If this alarm is engaged the system will not operate in **COOL**, **FAN** or **HEAT** mode.

H POWER/PHASE MONITOR

Standard on all KwiKool KPO products. The power monitor samples the power supply and shuts down the KPO and alerts operators with an alarm, **PF** displays on the control, and a red fault light displays on the monitor in the event of low or high voltage, incorrect voltage, incorrect phasing, or motor fault.

1. The monitor is factory set to reset automatically upon adjustment of the monitor or correction of the issue indicated on the monitor. The monitor is in the electrical control panel of the KwiKool and displays the reason for activation.
2. Clear the blinking fault history light by pressing and holding the fault button for 3 seconds.
3. See the troubleshooting guide for adjustment details if the KwiKool phase monitor is alarming and displaying faults. If this alarm is engaged the system will not operate in **Fan**, **Cool** or **Heat** mode.

I VFD-VARIABLE FREQUENCY DRIVE

Used on KPO systems in **COOL** Mode to optimize the operation of the condenser fan by slowing down and speeding up the rotations of the blower. This helps to maintain the best pressure needed to operate in the current environment. The VFD is in the supply return air compartment on KPO5 and KPO12. On KPO25 systems it is in the condenser motor compartment. The VFD displays the current operating frequency, or any error message needed for fault diagnosis. The condenser motor VFD will not operate the condenser fan in **HEAT** or **FAN** mode, as it is not needed for these modes.

SECTION VI APPLICATION REQUIREMENTS

A AIR TEMPERATURE REQUIREMENTS COOL MODE

The environmental requirements of the KwiKool unit at the installation site are 0 to 110 degrees F for the condenser make up air located on each side of the unit. Standard KwiKool KPO models are not designed to operate at temperatures below 60 degrees F. on the cooling side. Temperatures below 60 degrees F. will cause evaporator coil freezing.

- If the unit operates in an environment above 110 degrees F, the high-pressure switch may trip, stopping the unit's compressor. Instead of the compressor stopping, the operator may also notice diminished performance.
- The High-Pressure Switch is a manual reset type and located in the front service compartment on KPO5 and KPO12. The reset is in the return air compartment on the KPO25, and the system is equipped with two reset switches.
- Reset is accomplished by pressing the button on the switch located on the compressor discharge line. If the switch has tripped, the operator will feel a distinct click upon reset.

B CAPACITY & TEMPERATURE SETTINGS

Sizing of the KPO units is based on matching capacity to a specific heat load while maintaining a 72-degree F temperature. To reach temperatures below 72 degrees F, the unit must have extra capacity.

CAUTION

We recommend that the operator not set the temperature set point below 72 degrees F, unless there is excess cooling capacity beyond the heat load, since this may cause the unit's evaporator coil to freeze up.

C POSITIONING OF UNIT

The unit should be positioned as close to the space to be conditioned as possible with the return air duct directly around the area of highest load. Place the KwiKool system on a level surface to ensure proper condensate water flow and be sure the surface can support the weight of the KwiKool.

CAUTION

Do not block the return air duct of the unit since this will cause low performance and/or evaporator coil freezing while in cool mode.

NOTE

For the heat function to work properly, supply and return air must be in the space being heated. The system works by heating the air that is recirculating to the system and will raise the overall temperature of the space to the set point, if properly sized.

SECTION VII MAINTENANCE**A AIR FILTERS**

The KwiKool comes from the factory with filters installed on the evaporator inlet to prevent dust and debris from entering the system and circulating in the conditioned space. Factory installed filters are a disposable type and must be periodically checked and replaced based on the air quality of the conditioned space.

CAUTION

Failure to maintain the filters will cause restricted airflow and can lower overall unit performance.

The air filter(s) are in the supply air return.

1. Remove the return air panel by turning the slotted lock fastener to the horizontal position and lift to remove the panel.
2. Remove and replace the filters.
3. Return the air panel to its designated location and turn the slotted lock fastener to the vertical (locked) position.

B CONDENSER DRIVE BELTS

For KPO12 and KPO25 systems only, the KwiKool moves air over the condenser coil to remove heat from the conditioned space by way of a motor that drives a blower wheel. This wheel turns by way of a pulley and belt system.

1. Inspect/adjust these belts every 60 days of operation, replace as needed.
2. Located in the condenser access compartment on the control end of the KPO, release the two slotted fasteners to give the operator access to the condenser belts and motor.
3. Adjust the tension on the belts by adjusting the motor base.

CAUTION

Failure to maintain the drive belts will cause low performance, high-pressure trip or, in extreme cases, damage to the blower/motor in the event of a belt breaking. DO NOT ADJUST THE DRIVE PULLEY.

SECTION VIII - UTILIZING THE KWIKOOL KPO SYSTEM

In contrast to conventional air conditioners, which circulate air conditioning capacity evenly to a space. KwiKool systems are used for cooling an area with a high concentration of heat load, many times from electrical or computer equipment. Understanding the capabilities of the KwiKool can help the operator avoid problems.

KPO can provide spot cooling for workers or process cooling within a large space without the use of condenser ducting, such as a warehouse factory, or production areas. It can also provide spot cooling for workers or process cooling within a large space without the use of condenser ducting, such as a warehouse factory, or production areas. The KwiKool system is equipped with the necessary controls to maintain those environments.

SECTION IX – TECHNICIAN/STAFF SETTINGS

Entrance into this function is gained by a long press onto the **MODE** button until it beeps and flashes a lock icon, then a long press on the **FAN** button until it beeps, then release the **FAN** button and once again a long press on the FAN button. It will beep and then display P4.

Use the **FAN** and **MODE** buttons to scroll through the different settings.

TECHNICIAN PARAMETER LIST

Select **ON/OFF** to exit, or after 1 minute the display will default back to the operating screen.

P4- Lock Fan Button	Select 0 or 1	0- Unlock, 1-Lock
P5- Lock Mode Button	Select 0 or 1	0- Unlock, 1- Lock
P6- Lock On/Off Button	Select 0 or 1	0-Unlock, 1- Lock
P7- Lock Plus/Minus	Select 0 or 1	0-Unlock, 1- Lock
P11-T2 Display in seconds (optional deicer)	Select 0-240 seconds	Value appears on main display.
P12-Display supply air temp. (T3)	Select 0 or 1	0-Off, 1-On
P13-T3 Display in seconds (Supply air temperature display)	Select 0-240 Seconds	Value appears on main display
P14- Auto changeover enable (Heat/Cool)	Select 0 or 1	0- Disable 1-Enable

SECTION X - USER PARAMETER SETTINGS

A three-second press on the Settings button gains entrance into this function. Use the FAN and Mode buttons to scroll through.

USER PARAMETER LIST

Select **ON/OFF** to exit or after 1 minute the display will default back to the operating screen.

P30- Beeper enable	Select 0 or 1	0- Disable, 1- enable
P40-Filter counter	Hours/10- 0 thru 999	Read Only
P41-Filter counter reset	Select 1 to reset	Defaults back to 0
P42-Filter Alarm Delay	Days, select 0 thru 180	0- Disable
P84-Supply Air Value (T3 display)	F or C	Read Only
P100-Enable Dimming	Select 0 or 1	0-Disable, 1 Enable
P101-Dimming time	Min, Select 0 through 10	Defaults to 5
P102-Dimming brightness	% 1,5,10 through 90	Defaults to 10
P105-Brightness in active state	% 50 through 100	Defaults to 100
P201-Displays microprocessor board version	N/A	N/A

SECTION XI - ALARM CODES LIST**ALARM CODES LIST**

A1	Customer installed input	Optional, Normally Closed
A2	Customer installed input	Optional, Normally Open
CP	Condensate pump fault	Standard
LP	Low Freon level detected	Standard
HP	High Pressure detected	Standard
FD	VFD Fault	Standard
PH	Incoming Power Fault	Standard
FL	Run time for filter elapsed	Standard
FS	Freezing detected	Optional
DC	Deicer in cool	Optional

SECTION XII - KPO TROUBLESHOOTING GUIDE

KPO TROUBLESHOOTING TABLE

STARTUP

FAULT	POSSIBLE CAUSE	POSSIBLE SOLUTION
PHASE <ul style="list-style-type: none"> • Control displays PH • Audible alarm fails to clear on start-up • Phase monitor displays lock-out “Front Fault” 	Phase monitor detects phasing issue or improper power incoming	Exchange any line voltage wire with the other, verify incoming power.
LOW VOLTAGE <ul style="list-style-type: none"> • Control displays PH • Audible alarm fails to clear on start-up • Phase monitor displays, lock-out “Front Fault” 	Phase monitor detects voltage lower than factory setting.	Verify incoming power. Slowly lower voltage setting on monitor to match incoming power.
High Voltage <ul style="list-style-type: none"> • Control displays “PH” • Audible alarm fails to clear on startup • Phase monitor displays lock out “Front Fault” 	Phase monitor detects voltage higher than factory setting.	Verify incoming power. Slowly raise voltage setting on monitor to match incoming power.
System sounds audible alarm. Control displays CP, LP, or HP	A condition exists with the mechanical system involving pressure or condensate flow.	See advanced troubleshooting section below, or call 1-800-KwiKool.
System starts up but is not operating in the selected mode.	System is in time out; control is set above or below room temperature or control is adjusted out of operating parameters.	Wait 3 minutes, review operations guide, Set up control.

FAULT	POSSIBLE CAUSE	POSSIBLE SOLUTION
Systems with phase monitor starts up but go into PH and audible alarm when the compressor starts.	Phase monitor detects voltage drop.	Observe the phase monitor on start for fault lights and adjust accordingly, verify incoming power. If no fault light is present see advanced troubleshooting below
Power is supplied but control is blank	Low voltage circuit is not engaged	On 12 & 25 ton models turn on built in breaker, all models verify incoming power to contactor, reset switch on low voltage transformer
System starts up and cools but hot air exhaust fan speeds up and slows down.	Normal operating condition in cool mode, especially in low temperatures	No action required review operations guide.
Cool air flow is limited, water is dripping from the front of the system	Supply or return duct is collapsed, blocked or not installed, filters need to be replaced and/or the evaporator coil is freezing as a result of the above.	Verify that supply and return duct are installed to specification, remove or add duct as needed, check air filter for blockage. Restart when thawed.
Condensate is not pumping	Water is below pumping level. System is in fan or heat mode	Reservoir fills, Check for line crimping. Condensate is not developed in heat or fan mode.
System sounds audible alarm only and display reads CP.	Mechanical system has detected high water level in the condensate pump. System not level.	<p>Level System</p> <ul style="list-style-type: none"> • Inspect condensate pump for overflow and proper operation • Check condensate line for clog or crimping. Resets automatically upon correction. <p>Call 1-800-KwiKool.</p>
Display reads HP.	Mechanical system has detected high pressure.	<ul style="list-style-type: none"> • Correct condition with air flow in or out of the condenser: • Inspect/replace condenser drive belts • Check condenser motor for proper operation • Check condenser drive (VFD) for trip, reset if needed • High-pressure switch requires manual reset. The pressure switch is located in the service compartment on the compressor discharge line.

FAULT	POSSIBLE CAUSE	POSSIBLE SOLUTION
Display reads LP.	Mechanical system has detected low pressure.	Install service gauges to view pressure readings below 20 psi. Check for icing on the evaporator coil or low return air temperature. Resets automatically upon correction.
KPO control displays PH phase monitor displays lock out back fault.	A fault has been detected from the load side of a component circuit.	Inspect components for faulty or loose connections.
Chatter or hum is heard from the control box while unit is operating.	Incoming source power is poor, low voltage component is faulty.	This is not adjustable thru the phase monitor. Check for proper voltage selection on 208/230-volt units, and correct incoming power. Isolate low voltage controls to find faulty component.
Evaporator coil is freezing in cool mode.	<ul style="list-style-type: none"> • Low or restricted air flow. • Undersized capacity, unit constantly on, unable to achieve set point. • Low return air temperature out of factory specifications. • Service door open or off. Mechanical system malfunction.	Review duct engineering. <ul style="list-style-type: none"> • Direct return air to area of highest heat load. • Replace air filters. • Adjust set point to allow unit to cycle. • Add KwiKool system. • Close service compartment door. • Install service gauges to view pressures.
Control displays A1, if equipped.	Appears when Input from A1 is opened.	Fault detected from A1 input, confirm usage, and call 1-800-KWIKOOL if input code is not used but is displaying.
Control displays A2, if equipped.	Appears when Input from A2 is closed.	Fault detected from A2 input, confirm usage, and call 1-800-KWIKOOL if input code is not used but is displaying.
Control displays FD.	Appears when Input from FD is engaged. This occurs when the Condenser VFD has a fault.	Check VFD and all condenser fan and motor components including belts and pulleys.
Control displays FL If applied.	Appears when the time set for filter change has elapsed.	Check condition of air filters, replace as needed. Reset time for filter change. Found in technical settings.

FAULT	POSSIBLE CAUSE	POSSIBLE SOLUTION
Control displays FS, if equipped.	Appears if the evaporator coil is below 28 degrees F.	Using the MODE button, move from COOL to FAN for 10 minutes to help coil thaw. Automatic reset upon thawing.
Hot air exhaust fan (condenser fan) stops. FD displays and the High-Pressure Switch trips while the compressor is operating.	Condenser drive has detected a fault with the incoming electrical power or is not receiving an operating signal.	Check condenser motor drive (VFD) for trip. Reset if needed. Note displayed fault code on the drive and call 1-800 KwiKool if problem persists.