



**GLOBAL<sup>TM</sup>  
INDUSTRIAL**

*We can supply that.<sup>®</sup>*

**User's manual**

**Manual del usuario**

**Manuel de l'utilisateur**

**Customer Service  
US: 1-800-645-2986**

**Servicio de atención al Cliente  
US: 1-800-645-2986**

**Service à la clientèle  
Canada: 888-645-2986**

# Misting Kit

**Compatible with Global Industrial Outdoor-Rated Fans**

**Models 293030, 293031, 293032, 293033**

**Models: 293161, 293162**

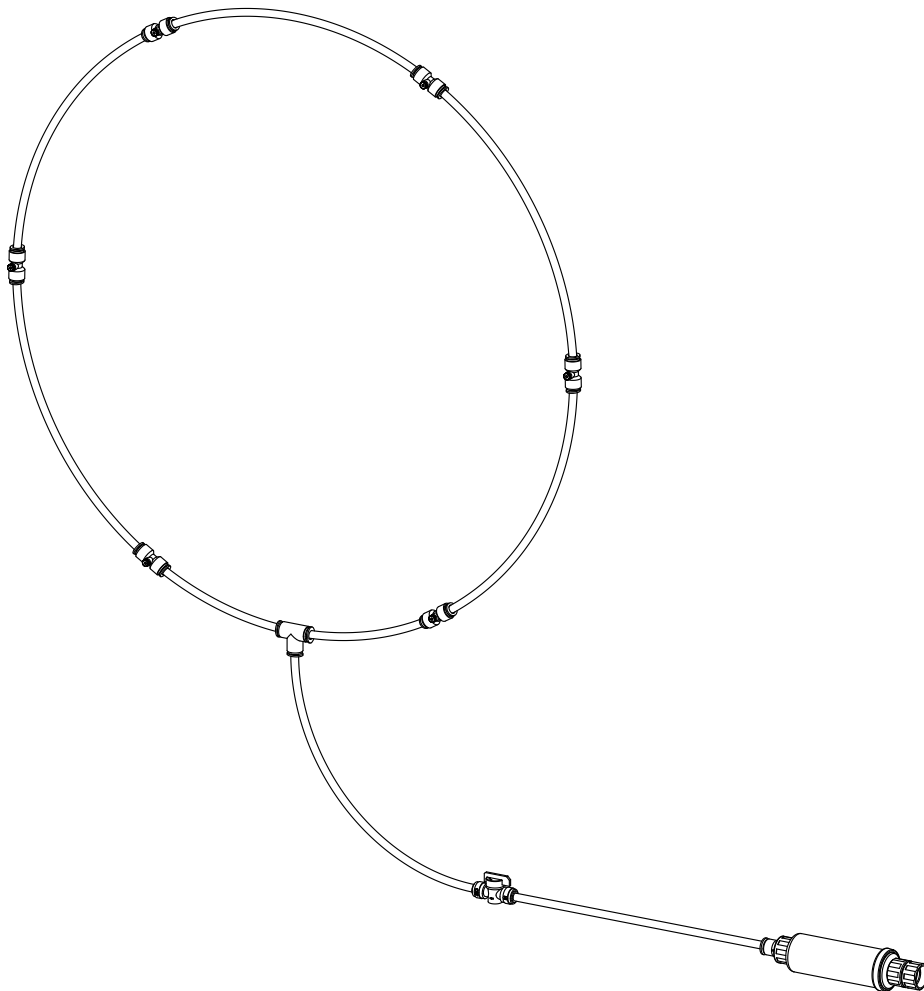

**PLEASE READ AND SAVE INSTRUCTIONS  
FOR FUTURE REFERENCE**

# Misting Kit

## Contents

Model 293161		
Part	Qty	Description
1	2	Short Tube
2	6	Long Tube
3	5	Nozzle
4	1	Union Tee
5	1	Filter
6	1	Valve
7	20	Cable Tie

Model 292162		
Part	Qty	Description
1	2	Short Tube
2	8	Long Tube
3	7	Nozzle
4	1	Union Tee
5	1	Filter
6	1	Valve
7	20	Cable Tie



1



2

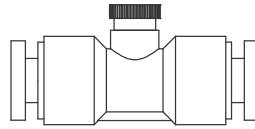

3

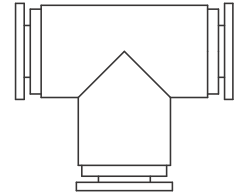

4

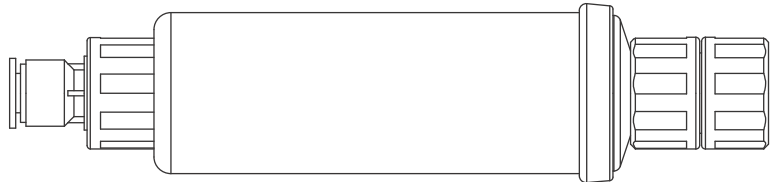

5

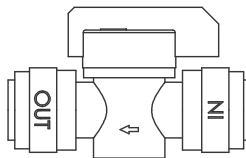

6



7

# Misting Kit

## Configurations

293161 (24" Model 293030)



293161 (24")	
Ring	
Qty	Description
3	Long Tubes
2	Short Tubes
4	Nozzles
1	Union Tee

To garden hose	
Qty	Description
2	Long Tubes
1	Valve
1	Filter

293161 (30" Model 293031)

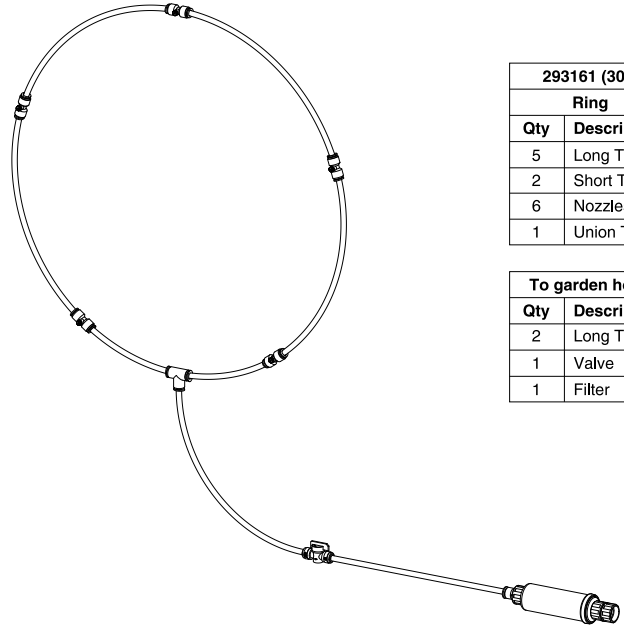

293161 (30")	
Ring	
Qty	Description
5	Long Tubes
2	Short Tubes
6	Nozzles
1	Union Tee

To garden hose	
Qty	Description
2	Long Tubes
1	Valve
1	Filter

293162 (36" Model 293032)

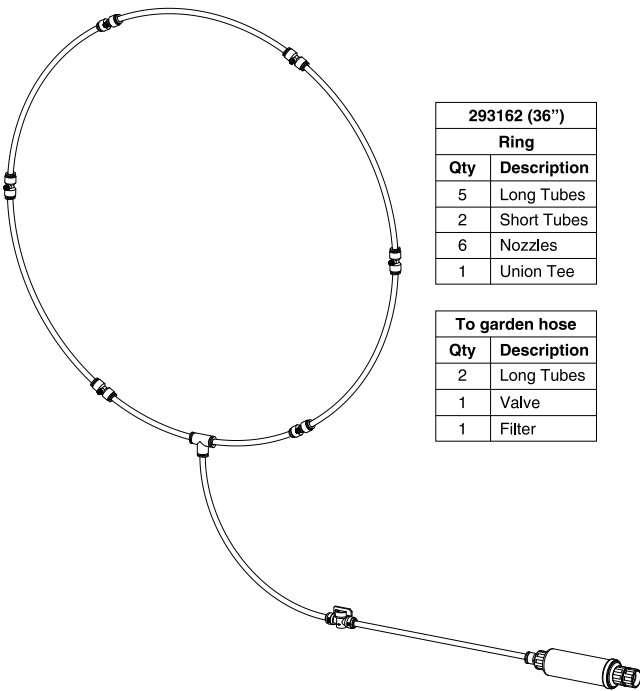

293162 (36")	
Ring	
Qty	Description
5	Long Tubes
2	Short Tubes
6	Nozzles
1	Union Tee

To garden hose	
Qty	Description
2	Long Tubes
1	Valve
1	Filter

293162 (42" Model 293033)

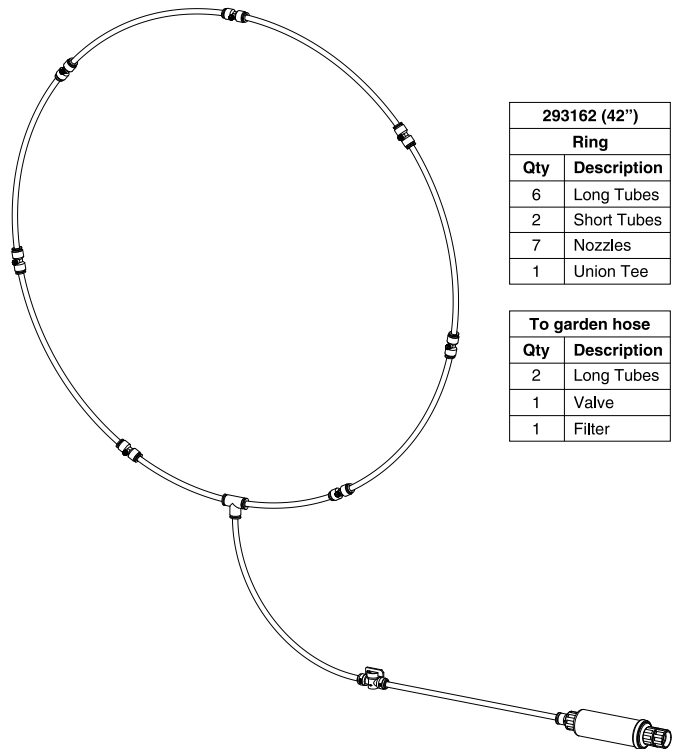

293162 (42")	
Ring	
Qty	Description
6	Long Tubes
2	Short Tubes
7	Nozzles
1	Union Tee

To garden hose	
Qty	Description
2	Long Tubes
1	Valve
1	Filter

# Misting Kit

## How to Install the Misting Ring

1. Position the misting ring at the front of the fan grill guard as shown in photo.
2. Fasten the misting ring to the fan grill guard using the cable ties included in the kit. With the cables ties, try to secure the ring to the (1/4-inch thick) straight wires of the guard, not just the thin curved wires, as shown in photo.

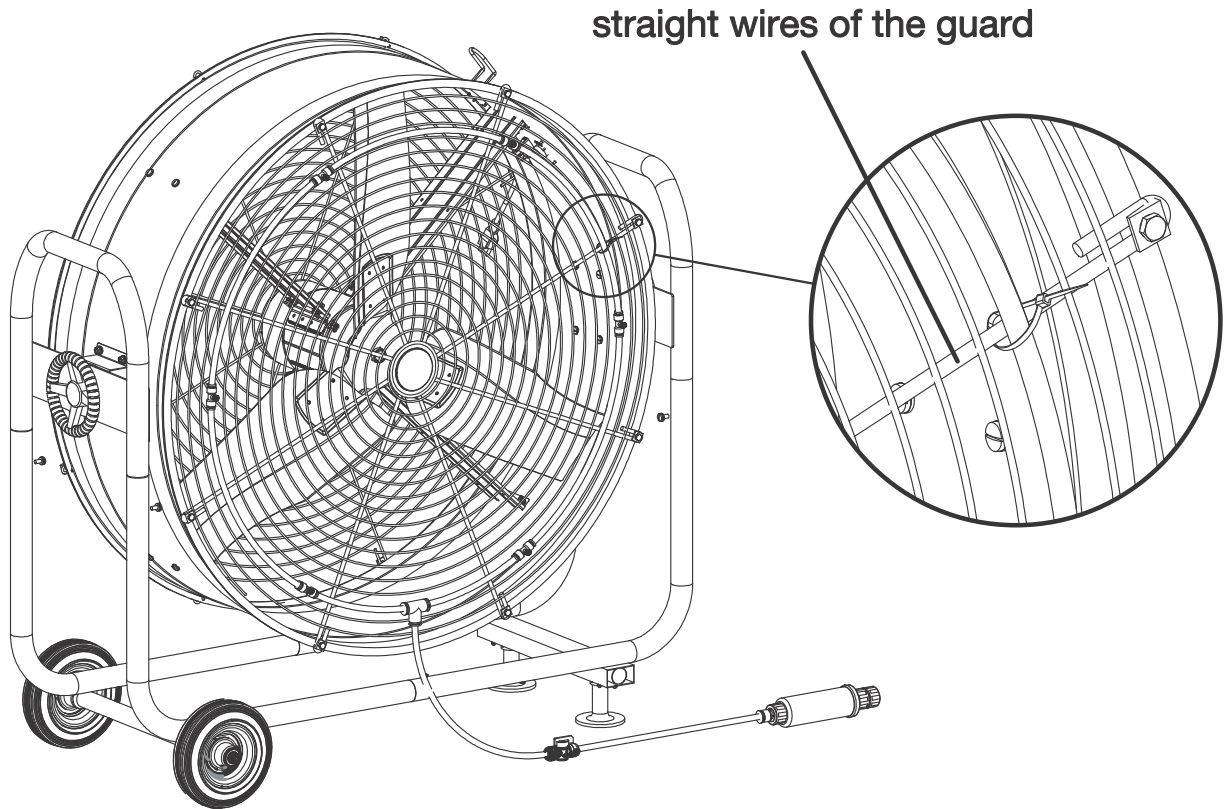

3. Install the filter so that the black arrow on the body of the filter points the same direction as the water flow. See photo for the arrow's location.
4. Attach the filter to the bottom of your fan using the ties included in the kit and as shown in photos.
5. Route the hose as shown in photo for your fan model and fasten it in place using the remaining ties.

Once the misting ring is installed, connect a water supply to the inlet. Position and start the fan. Turn on the water supply. With the fan running and the water supply flowing, mist will be created. The misting ring kit comes ready to connect to a standard garden hose fitting. With the proper adapters, it can also be connected to any water supply that provides up to a maximum of 60 psi pressure.

If the amount of misting seems to have decreased, the filter may be blocked. The filter will need to be replaced every 6 months.

### Nozzle Cleaning

1. Remove the nozzles from the misting ring by turning them counterclockwise.
2. Remove the nozzles and soak in vinegar overnight.
3. Rinse the nozzles and reinstall on the ring by turning clockwise.