

interion®

globalindustrial.com
1.800.645.1232

Assembly Instructions

Instrucciones de Ensamblaje

Directives d'assemblage

Customer Service
US: 1-800-645-2986

Servicio de atención al Cliente
US: 1-800-645-2986

Service à la clientèle
Canada: 888-645-2986

Interion® Reversible Return Desk Shell

48"W x 24"D: 695934MH, 695934MC, 695934GY

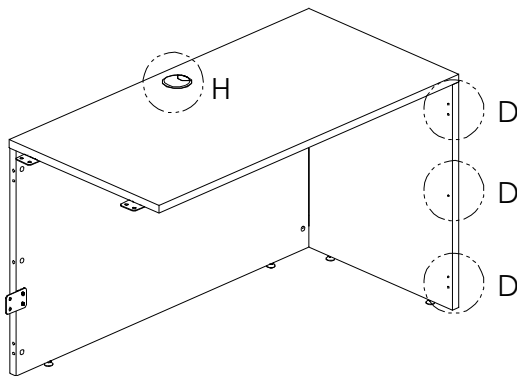
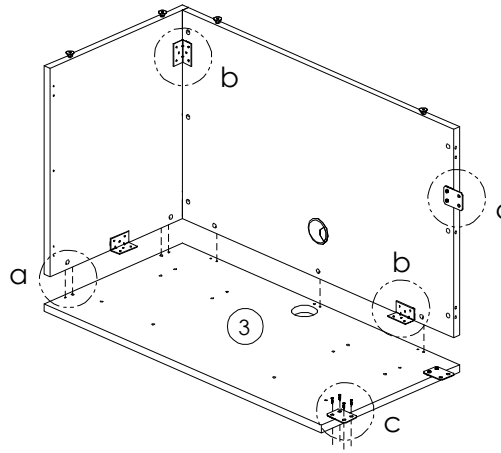
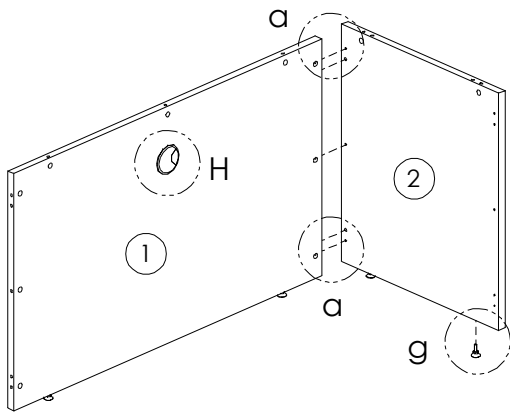

IMPORTANT:
FUNCTION OF KLIX CAM



1/4 RIGHT TURN FOR

LOCKING Make Sure The Arrow Is Pointing Upwards Before Inserting Into The Panel's Hole







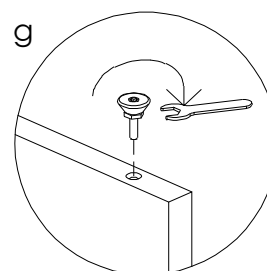
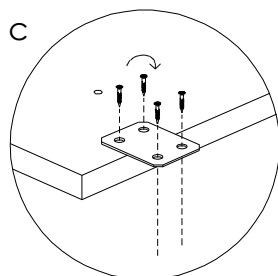
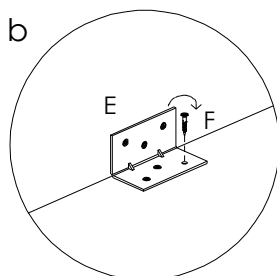
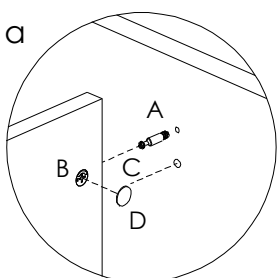

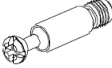

NOTE

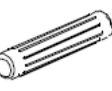
- Do not use power drill in Part A.
- 2 people are required to assemble and move desk.
- Assemble laminate boards on a smooth surface, such as a rug or carpet, in order to prevent the board from being scratched.
- Inspect item carefully for missing parts or damage.
- Do not assemble if parts are missing or damaged.
- During assembly, keep hardware away from children.

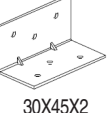

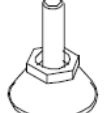
Hardware & Tools

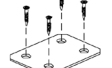
| Ref. | Qty. | Description |
|------|------|--|
| A | 13 |  |
| B | 13 |  |
| v | 10 |  M8X40 |
| D | 13 |  |
| E | 5 |  30X45X2 |
| F | 30 |  #8X5/8 |
| G | 4 |  M6X25 |
| H | 2 |  |
| I | 1 |  Wrench |
| J | 3 |  |